



July 2005  
ACU5122A  
ACU5142A

# ServSwitch Wizard Extenders

---

**CUSTOMER** Order **toll-free** in the U.S. 24 hours, 7 A.M. Monday to midnight Friday: **877-877-BBOX**  
**SUPPORT** **FREE** technical support, 24 hours a day, 7 days a week: Call **724-746-5500** or fax **724-746-0746**  
**INFORMA-** Mail order: **Black Box Corporation**, 1000 Park Drive, Lawrence, PA 15055-1018  
Web site: **www.blackbox.com** • E-mail: **info@blackbox.com**

# Contents



## Welcome

Introduction .....	2
Supplied items .....	3
Module features .....	4

## Installation and operation

Installation .....	5
Stage A - Configuration switch settings .....	5
LOCAL module switches .....	5
REMOTE module switches .....	6
Stage B - Mounting a module – desk or rack .....	7
Installation Advice .....	7
Stage C - Connections .....	8
Connections at the LOCAL module .....	8
Connections at the REMOTE module .....	11
Operation .....	14
Power and activity indicators .....	14
General use .....	14
User arbitration and keyboard indicators .....	14
Visible image shadows .....	14
Locking and unlocking the system .....	15

## Special configuration

Configuration .....	16
What are hotkeys? .....	16
Entering, using and exiting configuration mode .....	16
Password setting .....	17
Password override .....	17
Hot plugging and mouse restoration .....	18
Which restore setting do I use? .....	18
Microsoft and Logitech -specific mouse settings .....	18
Image controls - sharpness and brightness .....	19
Skew adjustment .....	20
Miscellaneous settings .....	21
Flash upgrade .....	22
Stage A - Download the upgrade files .....	22
Stage B - Create a startup diskette .....	22
Stage C - Reconfigure the LOCAL connections .....	23
Stage D - Reconfigure the REMOTE connections .....	23
Stage E - Return all connections to their usual states .....	23

## Further information

Troubleshooting .....	24
Getting assistance .....	24
Other products in the Wizard range .....	25
Radio Frequency Energy .....	26
Certification notice for equipment used in Canada .....	27
Normas Oficiales Mexicanas (NOM) safety statement .....	28
BlackBox subsidiary contact details .....	29

# Welcome



## Introduction

Thank you for choosing the Black Box ServSwitch Wizard extenders. Comprising two compact modules, these extenders allow you to place multiple video monitors and serial devices together with a keyboard, mouse and audio peripherals up to 200 metres from a computer system. In addition, locally connected video monitors, keyboard, mouse and speakers allow two users to simultaneously view the outputs of the host system and also take control of the system, providing it is not being used by the other user. A user relinquishes control two seconds after their last key press or mouse movement.

Two variants of the Multi Screen extenders are available, the ACU5122A model allows two video and serial channels, while the larger ACU5142A model

provides four separate channels. For both variants, a local module attaches to the computer system and provides connections for the local peripherals while the remote module is placed up to 200m away and handles the remote peripherals. The long distance link between the two modules is made by either two (ACU5122A model) or four (ACU5142A model) Category 5, or higher, twisted pair cables.

Special circuitry within the remote module allows you to make adjustments to the sharpness and brightness settings to suit your own preferences. Additionally, a Skew adjustment is also provided to counteract the effects of uneven lengths of twisted pair cables that are used to carry the video signals.

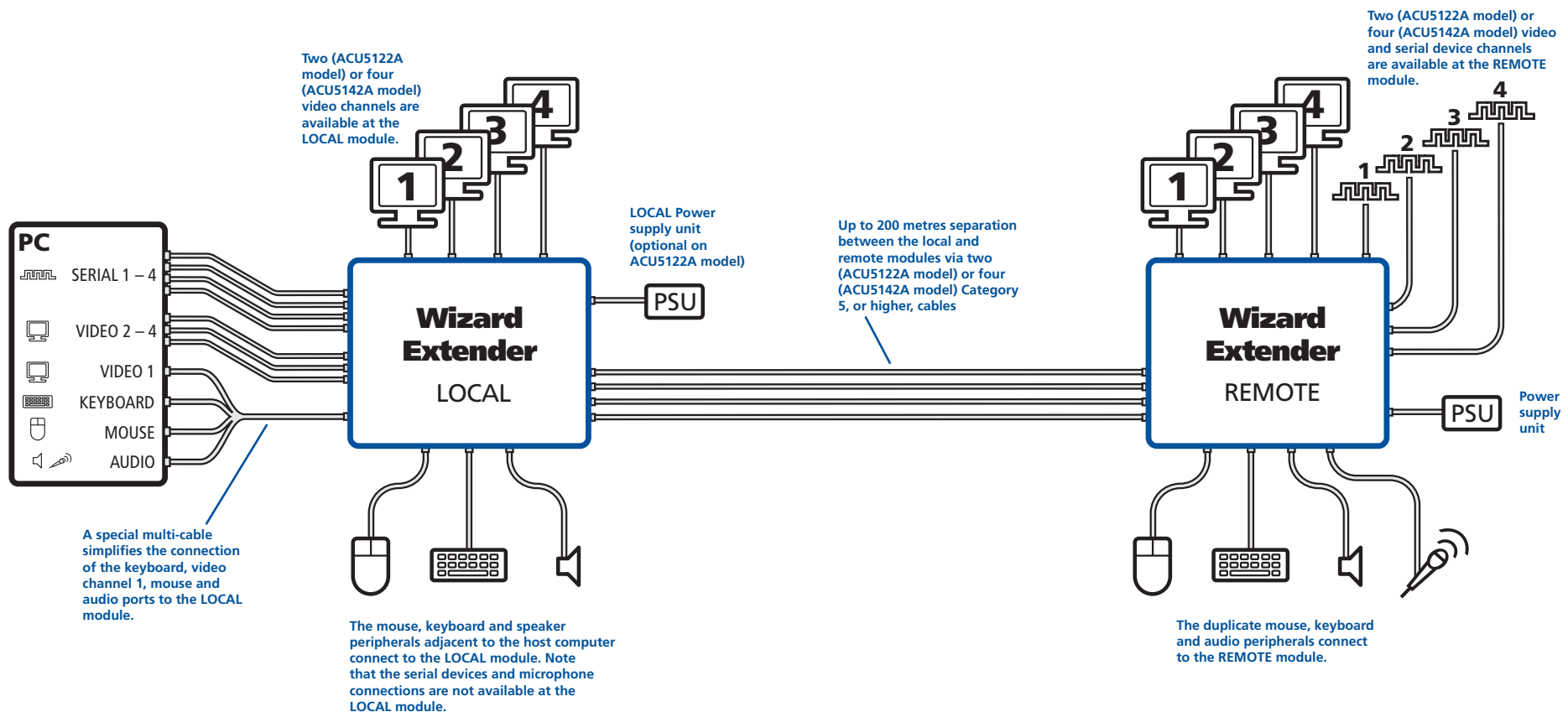

CONTENTS

WELCOME

INSTALLATION & OPERATION

SPECIAL CONFIGURATION

FURTHER INFORMATION

# Supplied items

## ACU5122A

LOCAL module

REMOTE module

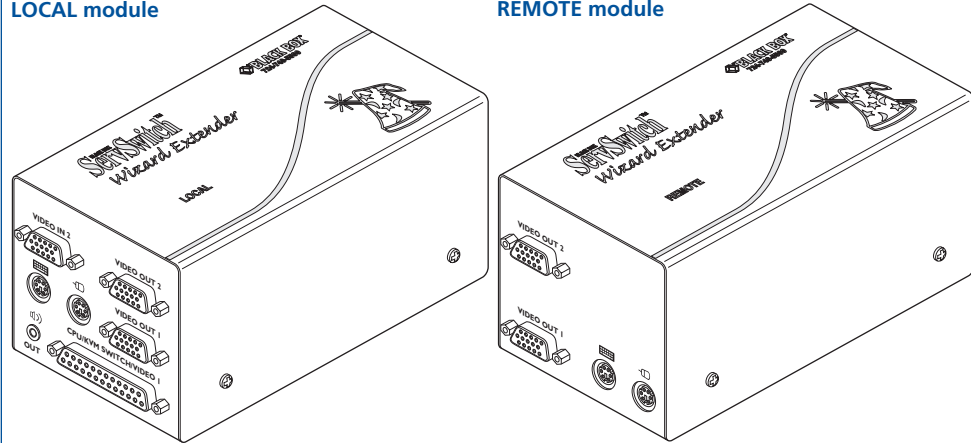

ACU5122A: Keyboard, mouse, audio, two video and two serial channels

OR

## ACU5142A

LOCAL module

REMOTE module

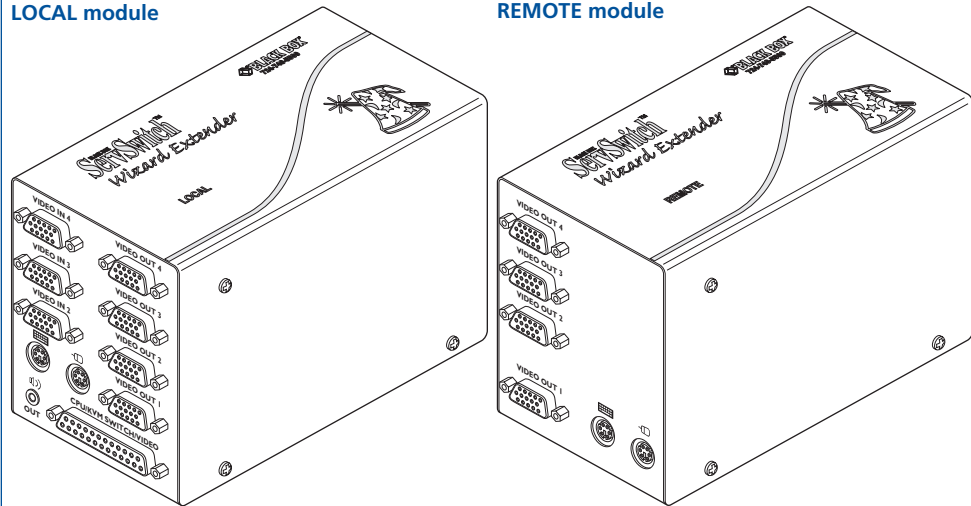

ACU5142A: Keyboard, mouse, audio, four video and four serial channels

Note: See next page for module features

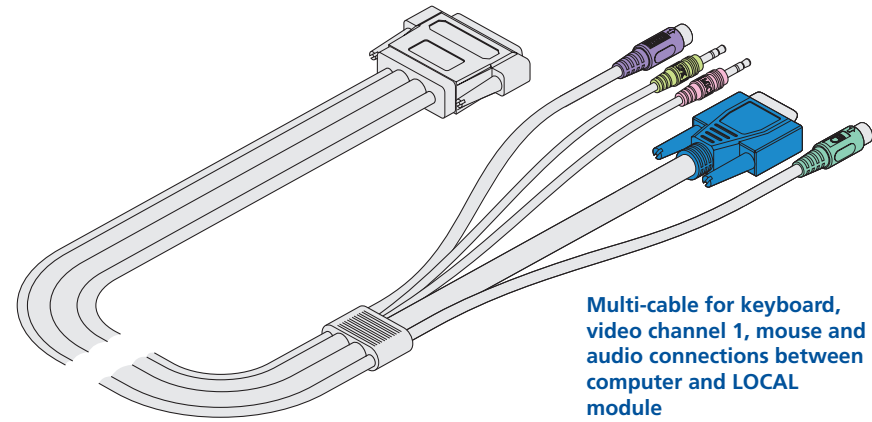

Multi-cable for keyboard, video channel 1, mouse and audio connections between computer and LOCAL module

Video cable for channels 2-4 (ACU5122A model has one video cable, ACU5142A model has three video cables)

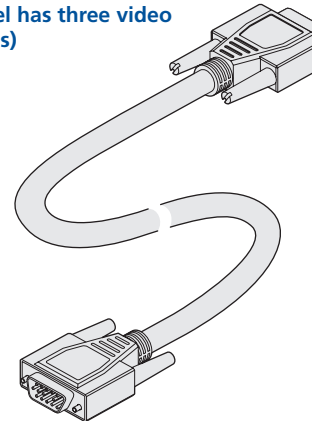

One serial cable for RS232 connection between computer and LOCAL module - additional cables available: P/N CAB-9M/9F-2M

Self adhesive rubber feet

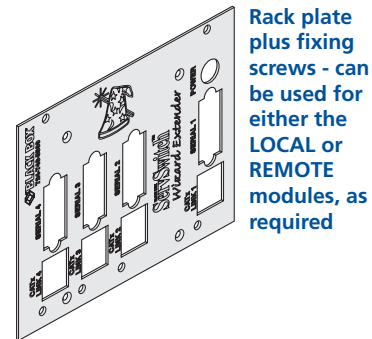
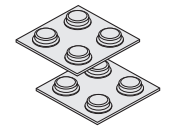

Rack plate plus fixing screws - can be used for either the LOCAL or REMOTE modules, as required

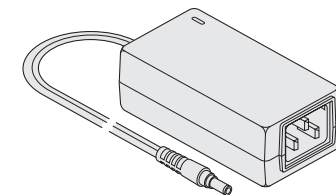

Power supply and country-specific mains cable (ACU5122A model has one PSU and cable, ACU5142A model has two PSUs and cables)



CONTENTS

WELCOME

INSTALLATION & OPERATION

SPECIAL CONFIGURATION

FURTHER INFORMATION

# Module features

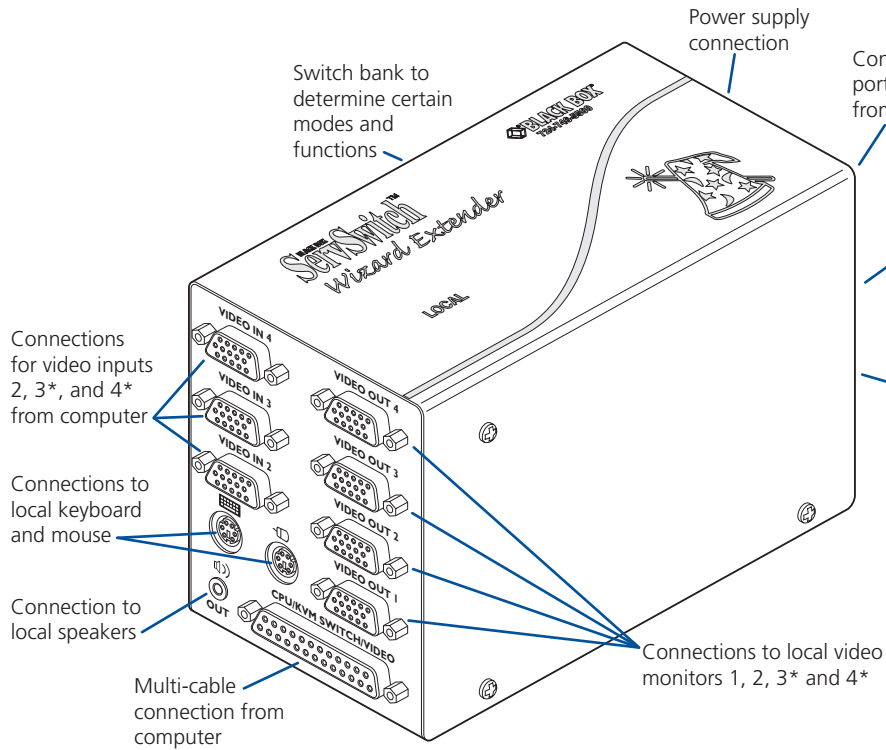

**LOCAL module**  
(ACU5142A model pictured)

**REMOTE module**  
(ACU5142A model pictured)

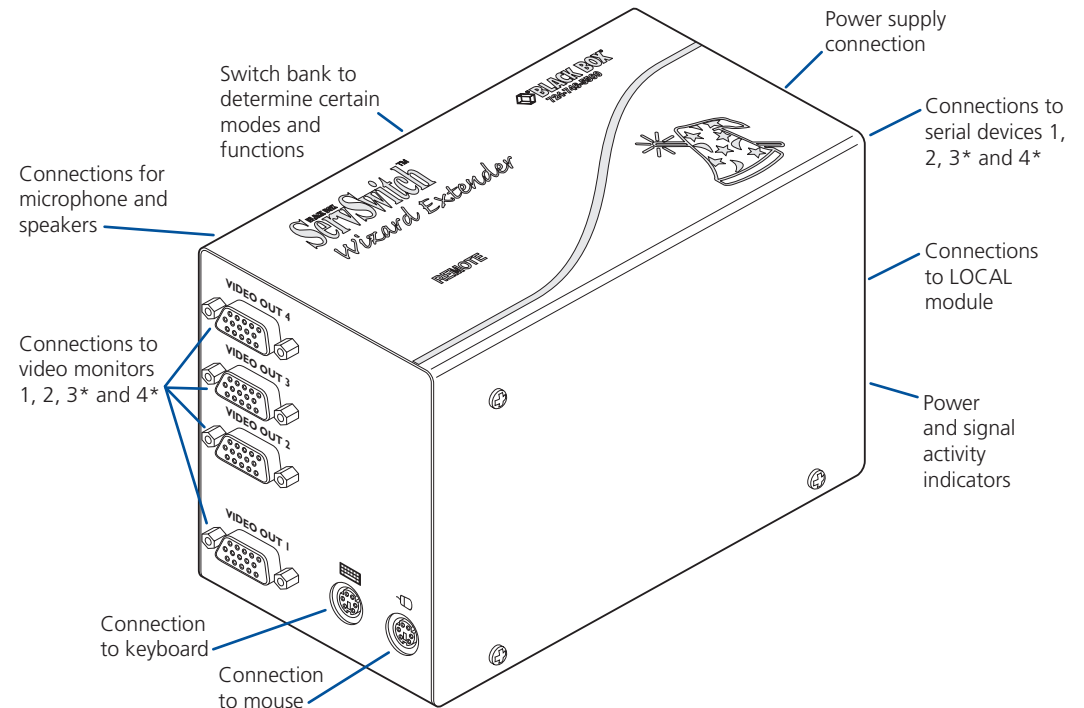

\* not available on ACU5122A model.

CONTENTS

WELCOME

INSTALLATION & OPERATION

SPECIAL CONFIGURATION

FURTHER INFORMATION

# Installation and operation



## Installation

The installation of the Wizard extenders is straightforward and can best be achieved in most cases by following these stages for each module:

- **Stage A** Check or set the configuration switch settings
- **Stage B** Mount the module
- **Stage C** Connect the cables

## Stage A - Configuration switch settings

The basic operation of the LOCAL and REMOTE modules are controlled by the banks of four switches located on the side of each module. The switches are monitored at all times and may be changed when power is on or off (the only exception to this rule is switch 1 of the LOCAL module which initiates slightly different functions depending on the power state when it is switched).

### LOCAL module switches

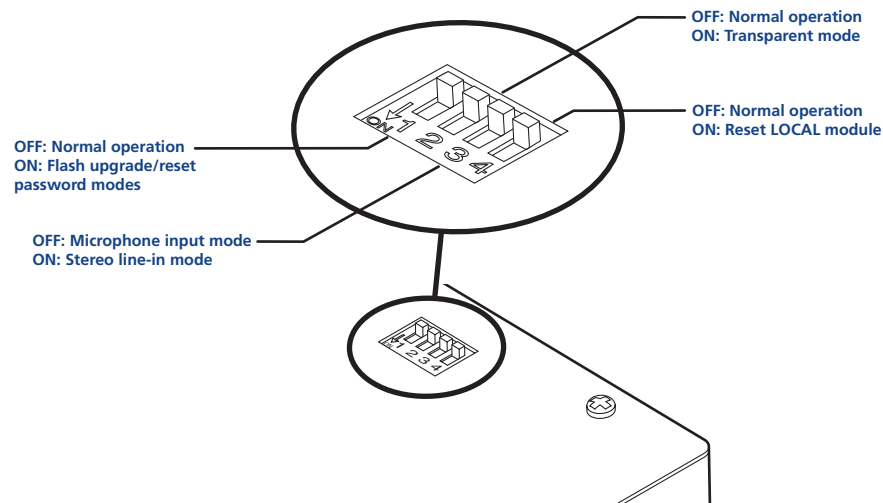

*Note: When shipped, all switches are set in the OFF positions and this will produce normal operation with normal microphone input (at the REMOTE module).*

### LOCAL module switches (continued)

#### LOCAL Switch 1

OFF: Normal operation.

ON: (Before power is applied) Places the LOCAL module into flash upgrade mode so that the internal software can be changed. Please see the 'Flash upgrade' section in the 'Special configuration' section.

ON: (Whilst power is applied) Places the REMOTE module into password override mode. This allows any pre-configured passwords to be altered - particularly useful when they have been lost or forgotten. Please see the 'Password override' section in the 'Special configuration' chapter.

#### LOCAL Switch 2

OFF: Normal operation.

ON: Set transparent mode. Use this setting if the Wizard modules are to be used with KVM switches from other manufacturers. Cascaded KVM switches often use special signals to set or identify conditions. In transparent mode, the Wizard modules will pass the signals without attempting to interpret them.

#### LOCAL Switch 3

OFF: Microphone input on REMOTE module. Use this setting if a standard mono-channel microphone is connected to the MIC input on the REMOTE unit.

ON: Stereo line-in input on REMOTE module. Use this setting if a stereo input is applied to the MIC input on the REMOTE unit.

#### LOCAL Switch 4

OFF: Normal operation.

ON: Suspend operation and reset the LOCAL module. Use this setting momentarily to produce the same effect as removing and restoring power if incorrect operation has occurred. Return the switch to the OFF position to allow normal operation to continue.

## REMOTE module switches

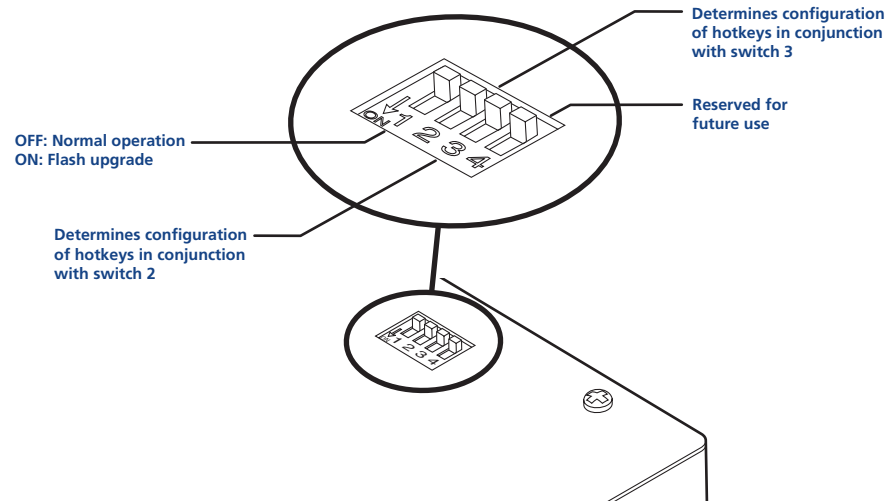

*Note: When shipped, all switches are set in the OFF positions and this will produce normal operation.*

## REMOTE module switches (continued)

### REMOTE Switch 1

OFF: Normal operation.

ON: (Before power is applied) Places the REMOTE module into flash upgrade mode so that the internal software can be changed. Please see the 'Flash upgrade' section in the 'Special configuration' chapter.

### REMOTE Switches 2 and 3

Switches 2 and 3 determine which two keyboard keys (when pressed in unison) are to be designated as 'hotkeys'. Hotkeys signal to the REMOTE module that the next key to be pressed is a special configuration command for the module and is not to be passed to the computer system.

2 OFF

3 OFF      Hotkeys = CTRL and SHIFT

2 OFF

3 ON      Hotkeys = ALT and SHIFT

2 ON

3 OFF      Hotkeys = CTRL and ALT

2 ON

3 ON      Hotkeys disabled

### REMOTE Switch 4

This switch is reserved for future use.



CONTENTS

WELCOME

INSTALLATION  
& OPERATION

SPECIAL  
CONFIGURATION

FURTHER  
INFORMATION

## Stage B - Mounting a module – desk or rack

The Wizard extender modules can be situated on a desk (or floor) or alternatively, for larger installations, mounted within optional rack mount chassis units.

### Desk mount

Apply the supplied self-adhesive rubber feet to the underside of the module(s).

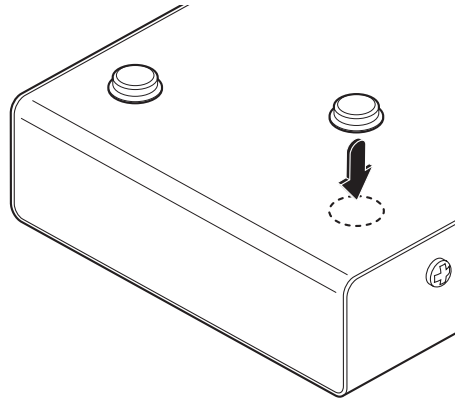

### Rack mount

*Note: The module switches are not accessible once it is inserted into the rack, therefore, check all settings before insertion.*

- 1 Place the supplied rack plate onto the front of the module and secure it with the countersunk screws.
- 2 Orient the module on its side so that its labelled face is the correct way up and the securing plate is facing away from the rack.
- 3 Slide the module into the required rack position. The rectangular cut-out in the front upper lip of the rack allows the screws on the module's upper edge to slide through.
- 4 The rack mount chassis has a series of holes in its floor that are spaced to accommodate the screws on the module's lower edge. Ensure that the screws correctly locate into the holes of the chosen slot. The rack securing plate on the module should now be flush with the front of the rack mount chassis.
- 5 Use the supplied (pan-head) screws, in the top hole of the rack securing plate to fasten the module to the rack.

## Installation Advice

- For correct operation, the local and remote units must have ground connections. At the computer end, ensure that the computer or KVM switch that the LOCAL module is connected to has a ground connection. At the keyboard/monitor/mouse end, ensure that the REMOTE module's power supply is connected to a grounded power outlet. Alternatively, a ground connection will be made via the monitor, if the monitor is itself grounded.
- Try to avoid laying the interconnect cables alongside power cables where possible.

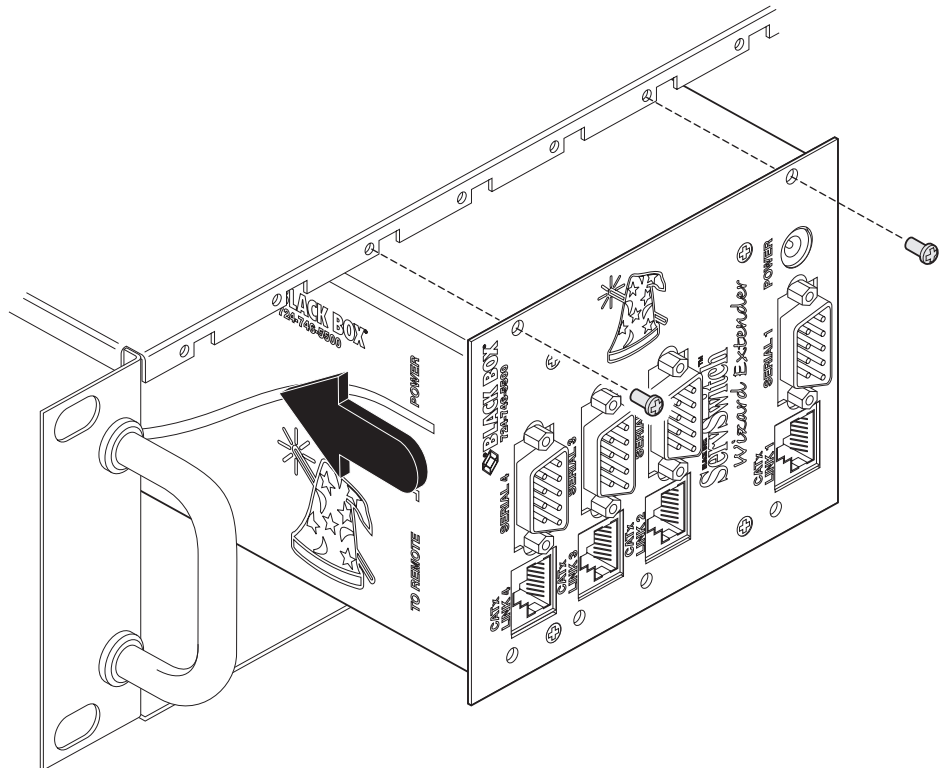

CONTENTS

WELCOME

INSTALLATION  
& OPERATION

SPECIAL  
CONFIGURATION

FURTHER  
INFORMATION



## Stage C - Connections

The naming of the LOCAL and REMOTE modules relate to their proximity to the host computer system. Hence, the LOCAL module connects directly to the system (and the local peripherals), while the REMOTE is at the other end of the twisted pair cable and attaches to the duplicate keyboard, mouse, etc.





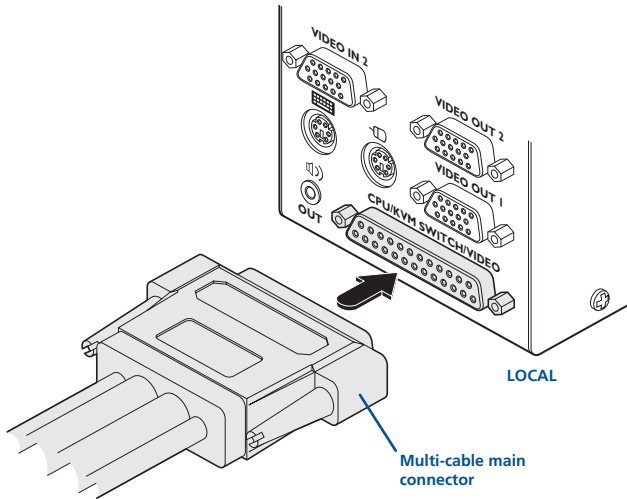

### Connections at the LOCAL module

#### Multi-cable connection

A number of important connections between the computer system and the LOCAL module are made via the supplied multi-cable. This cable is two metres in length and splits out to the keyboard, video, mouse, microphone and speaker ports of the system.



- 1 Attach the supplied multi-cable to the 25-way socket at the end of the LOCAL module.
- 2 At the other end of the multi-cable, attach the keyboard, mouse, primary video channel, microphone and speaker connectors to the appropriate sockets at the rear of the computer system. On most systems the appropriate ports should be labelled and colour coded in a similar way to the cable connectors:



<b>Monitor (video)</b>			Blue
<b>Keyboard</b>			Purple
<b>Mouse</b>		or	 Mid green
<b>Speaker</b>		or	<b>SPK</b> Light green
<b>Microphone</b>		or	<b>MIC</b> Pink (or maroon)

#### Local keyboard and mouse connections

The LOCAL module provides extra ports to accommodate a keyboard and mouse in the vicinity of the host system.

- 1 Connect the keyboard lead to the purple mini-DIN socket labelled  on the LOCAL module.
- 2 Insert the keyboard lead into the green mini-DIN socket labelled  on the LOCAL module.

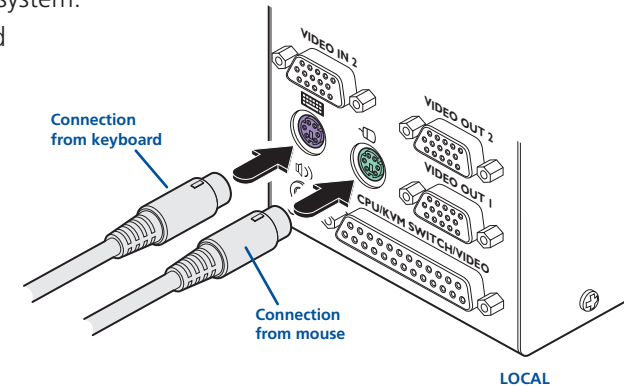

#### Local speaker connection

The LOCAL module allows a pair of speakers to be connected and used in the vicinity of the host system.

*Note: A microphone port is provided only at the REMOTE module.*

- 1 Connect the speaker plug to the socket labelled .

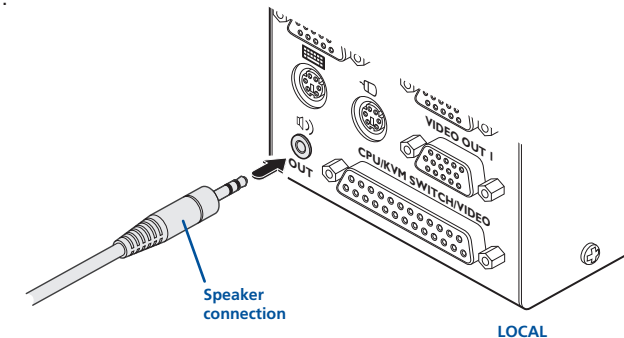

CONTENTS

WELCOME

INSTALLATION  
& OPERATION

SPECIAL  
CONFIGURATION

FURTHER  
INFORMATION

## Additional video channel inputs

The ACU5122A model provides a second video channel, and the ACU5142A model provides a further three channels, in addition to the main video channel that enters via the multi-cable connection.

- 1 Use the supplied video connection cable(s) to make a link between the additional video outputs of the computer system and input sockets (labelled **VIDEO IN 1** to **VIDEO IN 4**) on the LOCAL module.

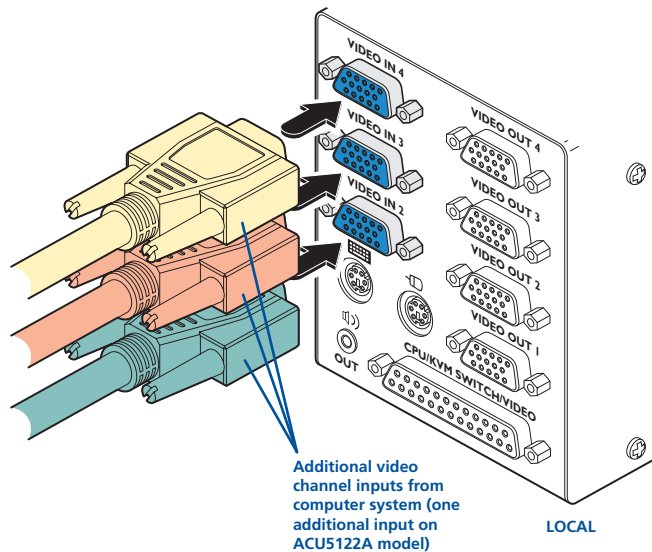

## Local video outputs

You can connect multiple video monitors in the vicinity of the host computer system (up to two on the ACU5122A model or up to four on the ACU5142A model).

- 1 Attach the signal leads from each video monitor to the output sockets (labelled **VIDEO OUT 1** to **VIDEO OUT 4**) on the LOCAL module.

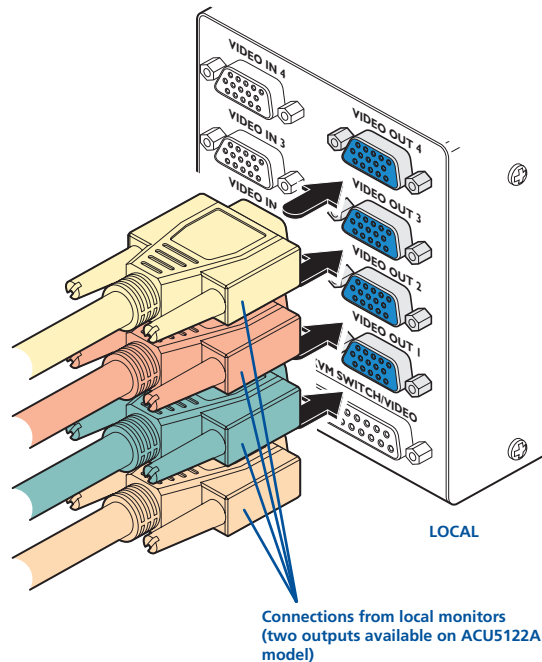

## Serial cable connections

You can transfer multiple serial connections from the host computer system to the remote module (up to two on the ACU5122A model or up to four on ACU5142A model) to accommodate devices such as touch screen inputs.

*Note: The links support software or hardware handshaking up to a maximum baud rate of 56Kb/s. It is not possible to attach duplicate serial devices at the LOCAL module.*

For each required serial connection:

- 1 Use a supplied serial link cable and attach the male connector of the cable to one of the 9 pin ports on the LOCAL module (labelled **SERIAL 1** to **SERIAL 4**).
- 2 Connect the other end of each serial link cable to the appropriate serial port of the computer system.

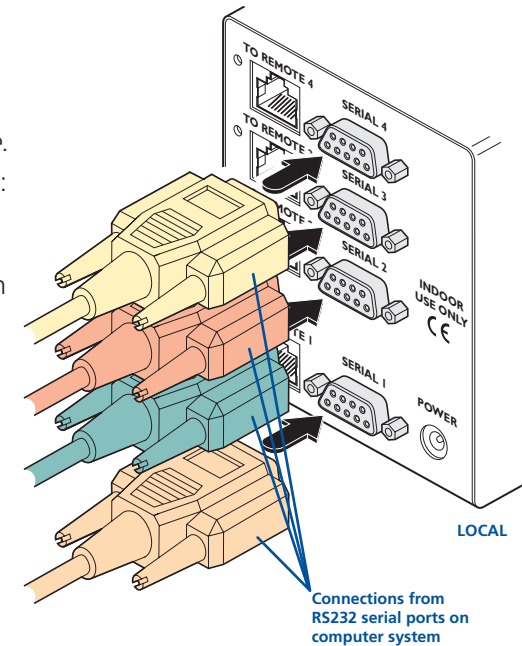

CONTENTS

WELCOME

INSTALLATION  
& OPERATION

SPECIAL  
CONFIGURATION

FURTHER  
INFORMATION



## Twisted pair link connections

The links between the LOCAL and REMOTE modules are made using between one and four twisted pair cables, specified to Category 5 or higher.

The various cable connections carry the following channel signals (if particular channels are not used, then corresponding link cables are not required):

Link cable	Channel signals carried
1	Keyboard, Mouse, Audio, Video 1, Serial 1
2	Video 2, Serial 2
3	Video 3, Serial 3 (not ACU5122A model)
4	Video 4, Serial 4 (not ACU5122A model)

**IMPORTANT:** Ensure that the total twisted pair cable length (including patch boxes) does not exceed 200 metres for any link cable. Ensure that the multiple link cables are all of the same length to avoid the risk of uneven delays on video images.

For each required link connection:

- 1 Insert the connector from the twisted pair cable link into one of the sockets (labelled **TO REMOTE 1** to **TO REMOTE 4**).
- 2 Ensure that the other end of the twisted pair link connects to the corresponding numbered socket on the REMOTE module (labelled **TO LOCAL 1** to **TO LOCAL 4**).

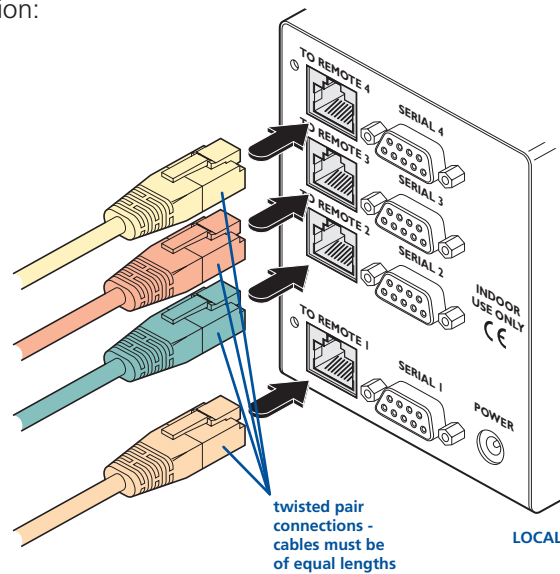

## Power connection (optional on ACU5122A model)

The ACU5122A and ACU5142A LOCAL modules both have power input sockets. However, only the ACU5142A model has a mandatory requirement for power input from a supplied adapter. The ACU5122A LOCAL module requires a separate power input only when the keyboard connection to the host system is not used. Separate power supply units are available from Black Box.

- 1 Attach the output connector of the power supply to the socket of the LOCAL module, labelled **POWER**.

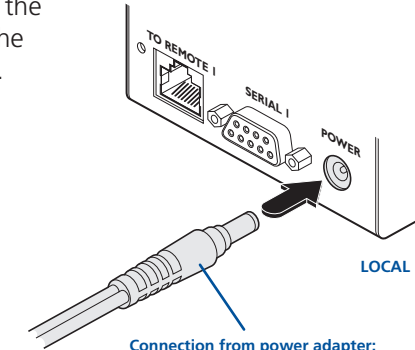

### Connection from power adapter:

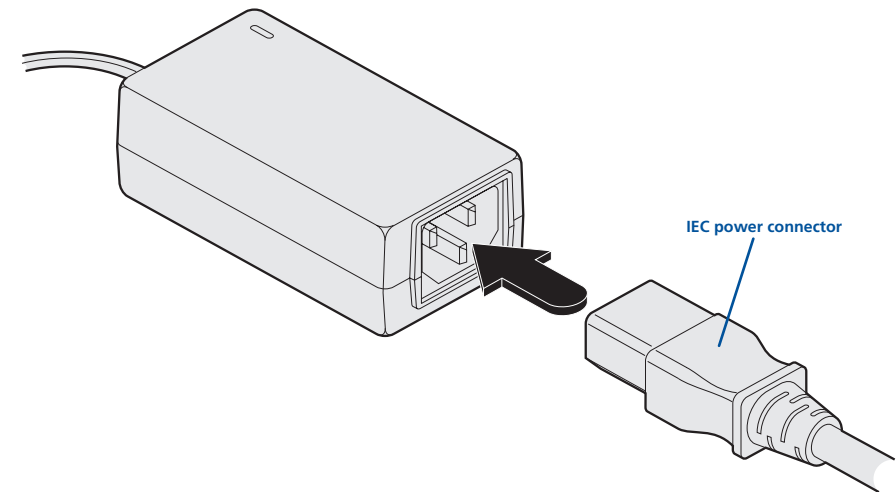

ACU5122A model - not required unless the host system keyboard connection is not used (secondary power adapter not supplied)  
 ACU5142A model - required in all cases (secondary power adapter supplied)

- 2 Insert the IEC connector of the supplied power lead into the corresponding socket of the power supply. Connect the other end of the power lead to a nearby mains socket.



## Connections at the REMOTE module

### Keyboard and mouse connections

- 1 Connect the keyboard lead to the purple mini-DIN socket labelled  on the REMOTE module.
- 2 Connect the keyboard lead to the green mini-DIN socket labelled  on the REMOTE module.

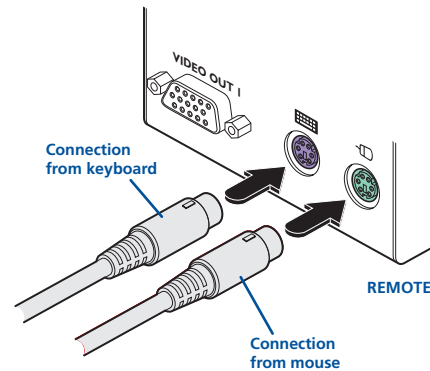

*Note: When the REMOTE module is rack mounted, the audio connections must be made after the module has been fixed in place. Access is required to the rear and above the rack. Remember to remove the audio connections before attempting to slide out the REMOTE module.*

### Audio connections

At the REMOTE module, audio connections are available from the two 3.5" jack sockets mounted on the side (same side as the switch bank). *Note: The microphone input (labelled ) has a dual function whereby it can either support a mono-channel microphone or alternatively receive stereo line input. Switch 3 on the LOCAL module controls the setting of this port: LOCAL switch 3 OFF - microphone, LOCAL switch 3 ON - stereo line in.*

- 1 Connect the microphone (or stereo line input) plug to the REMOTE module socket labelled .

*Note: Ensure that the setting of switch 3 on the LOCAL module matches the input to this socket:  
OFF-microphone;  
ON-stereo line input).*

- 2 Connect the speaker plug to the socket labelled .

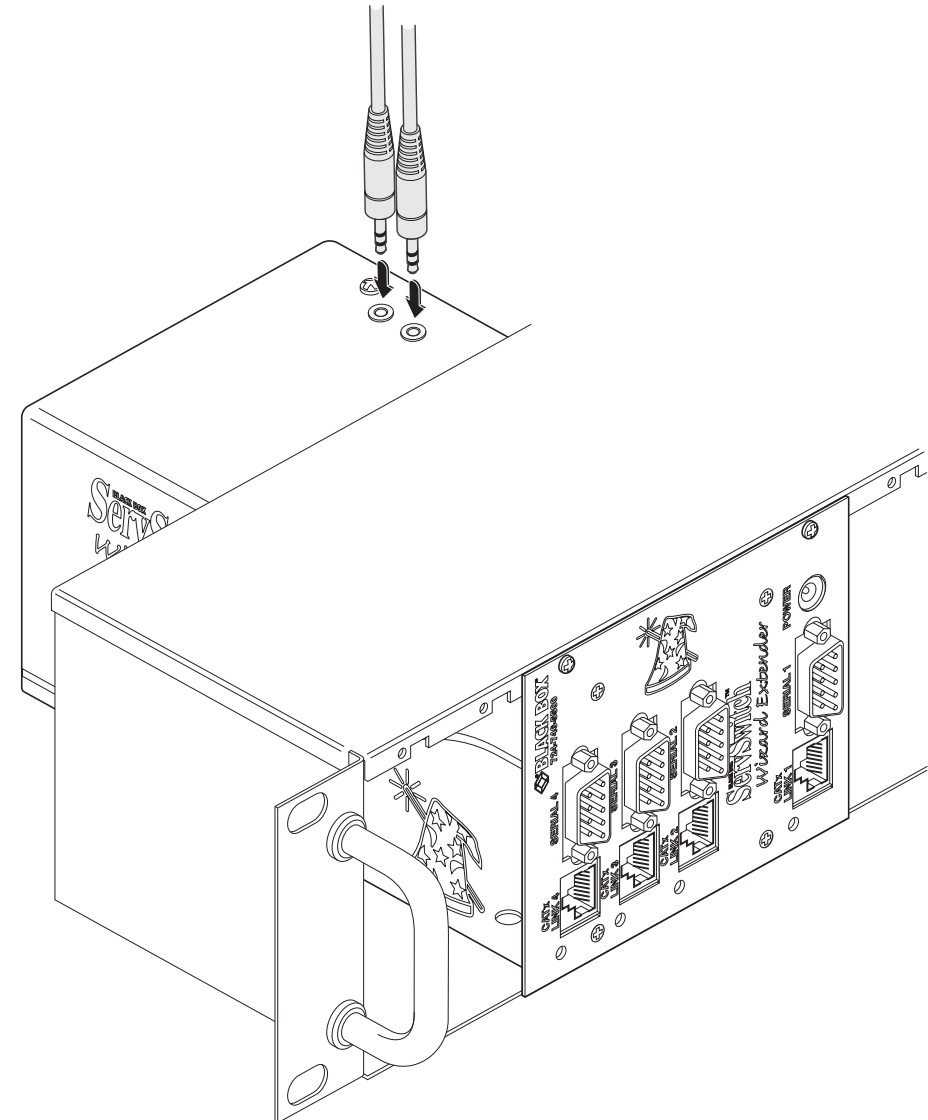
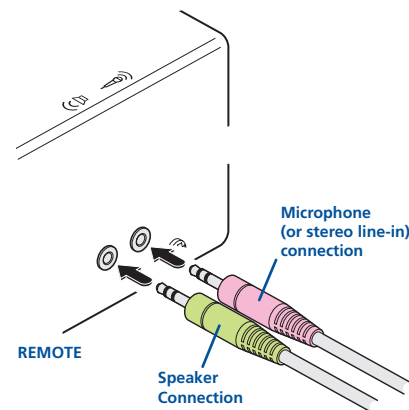

CONTENTS

WELCOME

INSTALLATION  
& OPERATION

SPECIAL  
CONFIGURATION

FURTHER  
INFORMATION



## Video outputs

You can connect multiple video monitors to the REMOTE module (up to two on the ACU5122A model or up to four on the ACU5142A model).

- 1 Attach the signal leads from each video monitor to the output sockets (labelled **VIDEO OUT 1** to **VIDEO OUT 4**) on the REMOTE module.

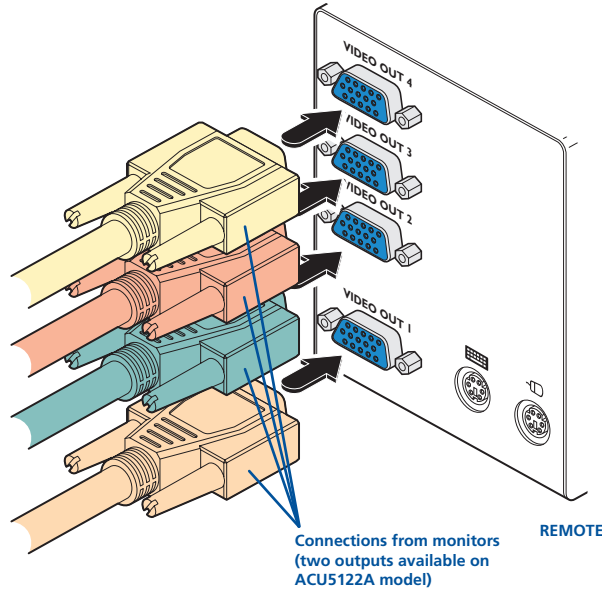

## Serial cable connections

You can attach multiple serial devices (such as touch screen inputs) to the remote module (up to two on the ACU5122A model or up to four on ACU5142A model).

*Note: The links support software or hardware handshaking up to a maximum baud rate of 56Kb/s.*

For each required serial connection:

- 1 Connect the cable from the serial device to one of the 9 pin ports on the LOCAL module (labelled **SERIAL 1** to **SERIAL 4**).
- 2 Ensure that the corresponding serial connection at the LOCAL module matches this device and the necessary port on the host system.

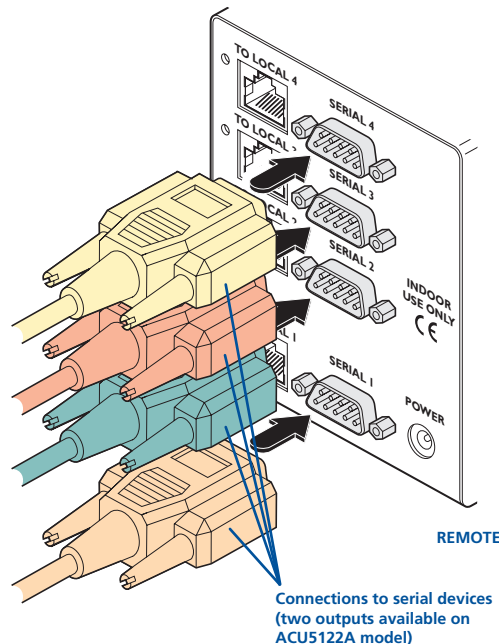

## Twisted pair link connections

The links between the LOCAL and REMOTE modules are made using between one and four twisted pair cables, specified to Category 5 or higher.

The various cable connections carry the following channel signals (if particular channels are not used, then corresponding link cables are not required):

Link cable	Channel signals carried
1	Keyboard, Mouse, Audio, Video 1, Serial 1
2	Video 2, Serial 2
3	Video 3, Serial 3 (not ACU5122A model)
4	Video 4, Serial 4 (not ACU5122A model)

**IMPORTANT:** Ensure that the total twisted pair cable length (including patch boxes) does not exceed 200 metres for any link cable. Ensure that the multiple link cables are all of the same length to avoid the risk of uneven delays on video images.

For each required link connection:

- 1 Insert the connector from the twisted pair cable link into one of the sockets (labelled **TO LOCAL 1** to **TO LOCAL 4**).
- 2 Ensure that the other end of the twisted pair link connects to the corresponding numbered socket on the LOCAL module (labelled **TO REMOTE 1** to **TO REMOTE 4**).

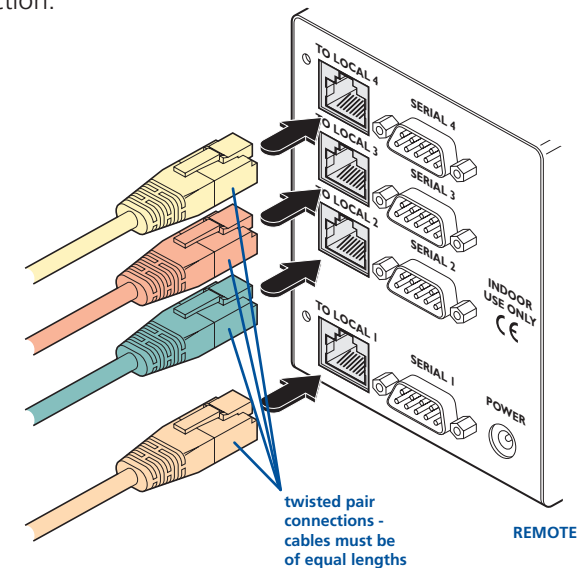

## Power connection

- 1 Attach the output connector of the power supply to the socket of the REMOTE module, labelled **POWER**.

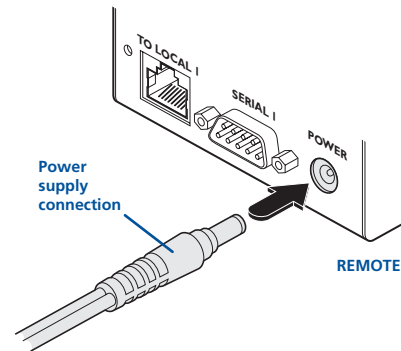

- 2 Insert the IEC connector of the supplied power lead into the corresponding socket of the power supply. Connect the other end of the power lead to a nearby mains socket.

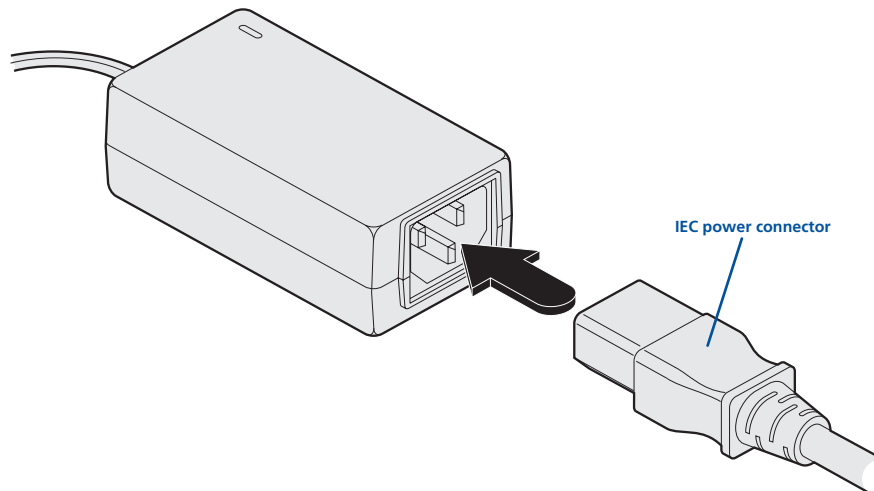

CONTENTS

WELCOME

INSTALLATION  
& OPERATION

SPECIAL  
CONFIGURATION

FURTHER  
INFORMATION

# Operation

## Power and activity indicators

On the front panels of all modules are small recessed indicators which provide confirmation of power and activity for each channel, as follows:

- Constant red - *power applied, no communication activity.*
- Flickering red - *power applied, mouse or keyboard activity occurring.*
- Slow flashing red - *module is in flash upgrade mode.*

Note: All modules contain internal automatic cut-out fuses to protect against power surges. To reset, remove power (or, for the LOCAL module, the multi-cable connection) from the module for one second and then reconnect.

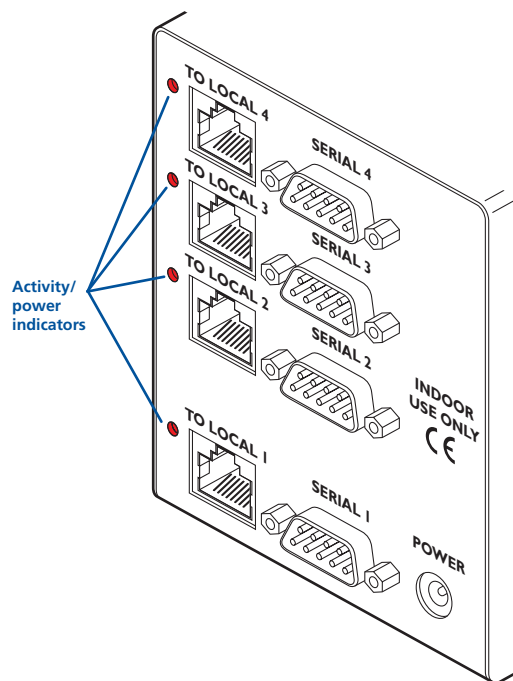

## General use

In use, the Wizard modules should be almost transparent - the system and its peripherals should operate almost exactly as normal, the only difference being that they are duplicated (see 'User arbitration' below) and one set is now up to 200 metres away.

### User arbitration and keyboard indicators

During operation, both of the connected video monitors continuously receive the output from the host system. Control of the host system is arbitrated by the Wizard modules on a first come, first served basis. In the idle state, control is available to both users and their keyboard indicators both show the current Num Lock, etc. conditions of the host system.

At the moment that a key is pressed or a mouse is moved, the keyboard and mouse of the other user are temporarily locked-out (the video images remain). The keyboard indicators of the locked-out user then begin to flash to confirm their status ⇒

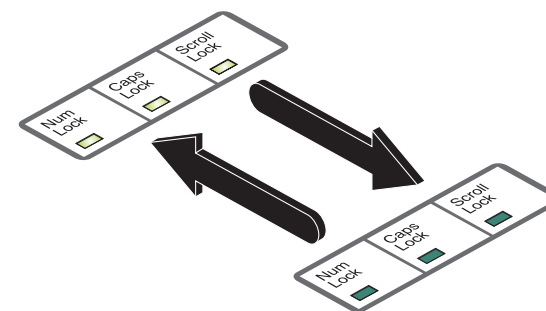

After two seconds of inactivity from the user currently in control, the modules return to their idle condition and re-instate the keyboard indicators of the locked-out user.

### Visible image shadows

In some installations, you may see some 'shadows' to the right of high contrast screen characters. This can be caused by an incorrectly selected sharpness setting and it may be necessary to make adjustments to correct this. Please see 'Image controls - sharpness and brightness' in the 'Special configuration' section.



CONTENTS

WELCOME

INSTALLATION & OPERATION

SPECIAL CONFIGURATION

FURTHER INFORMATION

## Locking and unlocking the system

In situations where the computer system (and the LOCAL module) can be locked away, the Wizard modules offer a viable security system to deter unauthorised use. Once a password has been set, a simple key sequence allows the system to be quickly and securely detached from its peripherals. Only the correct password will reconnect the remote and local modules.

### To lock the system

- 1 First set a password. For further details, please refer to the 'Password setting' section in the 'Special configuration' chapter.
- 2 Simultaneously press the currently configured hotkeys (by default, **Ctrl** and **Shift**) along with **L**.

*The screen will go blank and the three keyboard indicators will begin alternately flashing between the 'Num Lock' and 'Scroll Lock', and 'Caps Lock'. This sequence indicates that a password is required.*

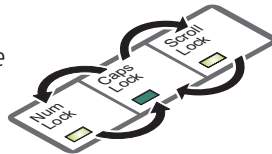

### To unlock the system

- 1 Enter the correct password and press **Enter**.

*Note: Passwords are NOT case sensitive.*

*Note: If an invalid password has been entered and the keyboard indicators are not flashing as described above, press **Enter** to clear the incorrect attempt.*

- 2 If the correct password is entered, the screen will be restored and normal operation can continue.

### To enable the video

Simultaneously press the currently configured hotkeys (by default, **Ctrl** and **Shift**) along with **F1**. This command will be required to restore the video if **Ctrl** and **Shift** along with **L** is used when no password has been set.

### To disable the video

Simultaneously, press the currently configured hotkeys (by default, **Ctrl** and **Shift**) along with **F0**.





# Special configuration



## Configuration

You can alter the way that the Wizard modules operate to suit your requirements. This is done using the Configuration mode and you can affect the following settings:

- *Password setting* – allows you to lock the remote module to prevent unauthorised system access.
- *Mouse restoration and settings* – allows you to restore mouse operation and also to change the mouse type.
- *Image controls - sharpness & brightness* – allows you to manually adjust the video image to ensure that it is crisp and bright.
- *Skew adjustment* – allows you to manually compensate for possible video errors introduced by long, uneven cable connections.
- *Miscellaneous functions* – report firmware version and restore settings.

### What are hotkeys?

Hotkeys are two normal keyboard keys that, when pressed simultaneously with a third key, signal to the Wizard modules that you are sending a message specifically to them and not to the computer. The hotkeys are ordinarily **Ctrl** and **Shift**, while a third keypress determines what you want the modules to do.

If the standard **Ctrl** and **Shift** hotkeys are also needed for computer tasks, you can change them for another combination using switches 2 and 3 on the REMOTE module:

- 2 OFF
- 3 OFF    Hotkeys = **Ctrl** and **Shift** (default setting)
- 2 OFF
- 3 ON     Hotkeys = **Alt** and **Shift**
- 2 ON
- 3 OFF    Hotkeys = **Ctrl** and **Alt**
- 2 ON
- 3 ON     Hotkeys disabled

## Entering, using and exiting configuration mode

### To enter and use configuration mode:

- 1 Simultaneously press the currently configured hotkeys (by default, **Ctrl** and **Shift**) along with **F1**.  
*The three keyboard indicators ('Num Lock', 'Caps Lock' and 'Scroll Lock') will now begin to flash in sequence to show that you are in configuration mode.*

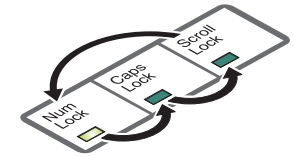

- 2 Press the first letter of the required configuration option, for instance **F**.  
*All three keyboard indicators will illuminate continuously.*

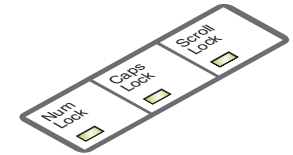

- 3 Press the number of the required configuration option, for instance **8**.  
*The 'Scroll Lock' indicator will extinguish, leaving the 'Num Lock' and 'Caps Lock' indicators lit.*

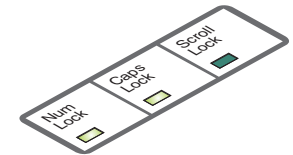

- 4 Press **F1** to confirm your option.  
*The three keyboard indicators ('Num Lock', 'Caps Lock' and 'Scroll Lock') will now begin to flash in sequence again.*

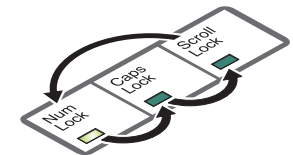

### To exit from configuration mode:

- 1 Within configuration mode, the three keyboard indicators should be flashing in sequence to show that the module is ready to receive a new command.
- 2 Press **F1**.  
*The three indicators will return to their normal states.*

## Password setting

Password protection allows you restrict access to the system only to authorised personnel. A password first needs to be set and then, using the keyboard attached to the REMOTE module, a simple key sequence allows the system to be quickly and securely detached from its peripherals.

### To set a password

- 1 Simultaneously, press the hotkeys (by default, **Ctrl** and **Shift**) along with **F1** to enter configuration mode.
- 2 Press **P** followed by **F1**.
- 3 Now enter your new password, within the following constraints:
  - Passwords are NOT case sensitive,
  - Passwords may be any length from one character to a maximum of forty characters,
  - The following keys may NOT be used: **Ctrl**, **Alt**, **Shift**, or **F1**
- 4 When you have entered the password, press **F1** to signal its completion.
- 5 Press **F1** once more to exit configuration mode.

For full details about how to lock and unlock the system using your password, please see the 'Locking and unlocking the system' section in the 'Installation and operation' chapter.

## Password override

This mode allows you to override the password that has been set at the REMOTE module and place it into configuration mode so that a new one may be set. This feature is particularly useful when passwords have been lost or forgotten.

### To override the REMOTE password

- 1 Remove power from the REMOTE module.
- 2 With power to the system and LOCAL module still applied, change LOCAL switch 1 to the ON position.
- 3 Re-apply power to the REMOTE module. The REMOTE module will go directly into configuration mode so that the old password can be cleared and a new one set.
  - **To clear a password:** (within configuration mode) Press **P** followed by **F1** and followed by **F1** again.
  - You can now enter a new password using the procedure outlined in steps 2 to 5 of the 'Password setting' section, or press **F1** to exit configuration mode.
- 4 Return LOCAL switch 1 to its OFF position.

*Note: If switch 1 remains ON, then the REMOTE module will enter configuration mode whenever it is repowered and will not operate normally.*



## Hot plugging and mouse restoration

It is strongly recommended that you switch off the computer system before attempting to connect it via the Wizard modules. However, if this is not possible then you need to 'hot plug' the modules while power is still applied to the system. There is not normally a danger of damage to the system, however, when mouse communications are interrupted, often they fail to reinitialise when reconnected. The modules provide a feature to reinstate mouse communications once the necessary connections have been made.

There are two main types of data formats used by current PC mice, these are the older 'PS/2' format and the more recent 'IntelliMouse®' format introduced by Microsoft. These use slightly different data arrangements and it is important to know which type was being used before you hot-plugged the modules. The previous setting depends both on the type of mouse and the type of driver as various combinations of PS/2 and Intellimouse are possible. Using the incorrect restore function may produce unpredictable results and require the system to be rebooted.

### Which restore setting do I use?

The general rule is that unless both the mouse *and* the driver are *both* Intellimouse compatible then you need to restore the mouse as 'PS/2'.





### Recognising an Intellimouse-style mouse

The Intellimouse format was introduced to support, among other features, the scroll wheel function. If your mouse has a scroll wheel, then it is likely to support the Intellimouse format. If you have a Microsoft mouse, then it will usually state that it is an Intellimouse on its underside label.

### Recognising an Intellimouse driver

Before hot plugging the modules (or afterwards using only keyboard control), access the Windows Control Panel and select either the *Mouse* option (on Windows NT, 2000 and XP) or the *System* option (on Windows 95, 98, ME). Look for the name of the driver, which will usually include the words *PS/2* or *Intellimouse*.





### To restore mouse operation when hot plugging:

- 1 Carefully connect the modules to the system and its keyboard, mouse, monitor, audio and serial device.
- 2 Simultaneously, press the hotkeys (by default, **Ctrl** and **Shift**) along with  to enter configuration mode.
- 3 Enter the appropriate restore function code:
  - *PS/2* – press **M** **6** 
  - *IntelliMouse* – press **M** **7** 
- 4 To exit configuration mode, press .
- 5 Move the mouse a short distance and check for appropriate on-screen cursor movement. If the mouse cursor darts erratically around the screen, then cease moving the mouse. This is an indication that the chosen restore function is incorrect. Try again using the other restore function.  
*Note: The restore functions predict the likely mouse resolution settings but may not restore the exact speed or sensitivity settings that were originally set.*

## Microsoft and Logitech -specific mouse settings

In certain installations some Logitech mouse drivers may lose the action of the mouse buttons when used with the standard 'Microsoft compatible' signalling protocol used between the modules. To solve this problem, select the 'Logitech compatible' mouse signalling protocol.

### To change mouse signalling protocols

- 1 Simultaneously, press the hotkeys (by default, **Ctrl** and **Shift**) along with  to enter configuration mode.
- 2 Enter the appropriate protocol code:
  - *Microsoft compatible* – press **M** **3** 
  - *Logitech compatible* – press **M** **4** 
- 3 To exit configuration mode, press .



## Image controls - sharpness and brightness

The Wizard modules incorporate special controls to compensate for losses incurred within long cable links. Using these controls you can adjust the picture sharpness and brightness to improve your remote picture quality.

The need for image control adjustment is best discovered when viewing high contrast images with vertical edges, such as black lines on a white background. When doing so, if you notice that the screen image is 'fuzzy' or 'dark' then the image controls may be able to solve this condition.

*Note: If the high contrast images exhibit shadows with separate colours, then there may be a skew problem which requires a different image adjustment - see the 'Skew adjustment' section for details.*

**IMPORTANT:** The sharpness and brightness adjustments affect ALL video channels equally. It is important to ensure that all twisted pair link cables are of equal length and have similar twist characteristics.

### To display a suitable high contrast image

The best way to clearly view the effect of sharpness and brightness adjustments is to display a high contrast image, with vertical edges, on the screen.

- Open a word processor, type the capital letter 'H', or 'M' and increase the point size to 72 or higher. For best results, the background should be white and the character should be black.
- A BLACK shadow on the right of the character indicates UNDER compensation.
- A WHITE shadow on the right of the character indicates OVER compensation.

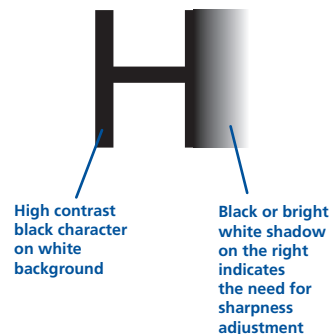

#### If the image controls cannot provide a crisp image

If, after adjusting the image controls, the screen image remains fuzzy or has coloured shadows you may need to use the Skew adjustment feature. Please see the next section for details.

### To use the image controls

- 1 Simultaneously, press the hotkeys (by default, **Ctrl** and **Shift**) along with **↓** to enter configuration mode.

*The three keyboard indicators ('Num Lock', 'Caps Lock' and 'Scroll Lock') will now begin to flash in sequence. The speed of the sequence indicates the level of the sharpness adjustment currently applied: the slower the rate, the lower the level of sharpness being applied.*

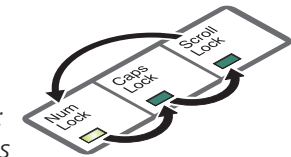

- 2 While viewing the displayed high contrast screen image, use the following keys to adjust the controls:

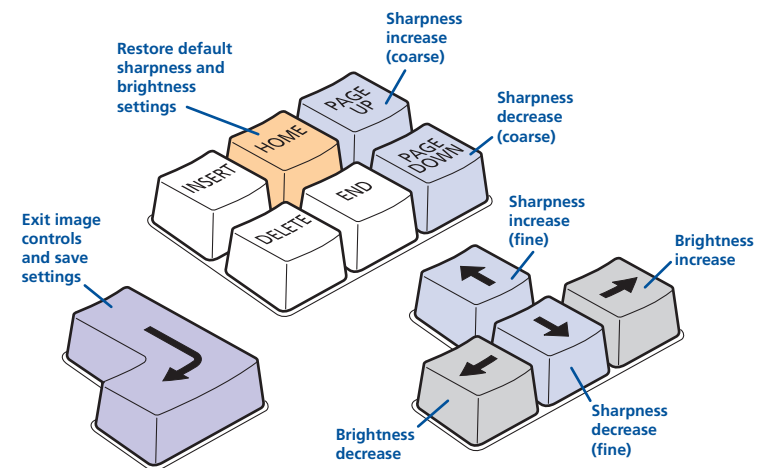

**Sharpness:** **↑** **↓** for fine adjustment, **Page Up** **Page Down** for coarse adjustment.

There are 255 sharpness levels (one coarse step jumps 10 levels).

To autoset sharpness: Press **F2** **2** **↓** to make the module calculate and apply an automatic compensation level - you can use this as a starting point for your fine tuning.

*Note: If the monitor goes blank and switches off (due to oversetting the sharpness adjustment) press the **Home** key to restore.*

**Brightness:** **←** **→** for adjustment. There are 255 brightness levels.

- 3 When no shadows are visible and the displayed images have crisp edges, press **↓** to exit configuration mode and permanently save all settings. The new compensation setting will be stored, even when power is removed or if a complete reset is initiated. The setting should not require further changes unless the cabling arrangement is altered.



## Skew adjustment

The twisted pair cabling supported by the Wizard modules (category 5, or higher) consists of four pairs of wires per cable. Three of these pairs are used by the modules to convey red, green and blue video signals to the remote video monitor. Due to the slight difference in twist rate between these three pairs, the red, green and blue video signals may not arrive at precisely the same time. This is visible as separate colour shadows on high contrast screen images. This effect is particularly apparent when using higher screen resolutions and some types of category 5e cables.

In this situation, the modules provide internal skew adjustment that can help to rectify the situation. The skew adjustment works by delaying or advancing the timing of any of the red, green or blue colour signals so that they are all delivered to the monitor at precisely the same time. For best results a test pattern is provided and this should be displayed when using skew adjustment.

**IMPORTANT:** The skew adjustments affect ALL video channels equally. It is important to ensure that all twisted pair link cables are of equal length and have similar twist characteristics.

### To use skew adjustment

1 Insert the supplied Installation CD-ROM into the CD player of the computer.

2 Within Windows, use the *My Computer* option (usually available as a desktop icon or within the Start menu) to view the contents of the CD-ROM. Double-click the **Skew** entry to display the standard test pattern. If necessary, maximise the application window so that the image fills the screen.

The screen will show a series of fine red, green and blue crosses which should all be in line, vertically and horizontally. Skew affects the horizontal placement of the colours and using this pattern it is much easier to discover which, if any, colours are being adversely affected by the twisted pair cable run.

3 Simultaneously, press the hotkeys (by default, **Ctrl** and **Shift**) along with **F4** to enter configuration mode.

The three keyboard indicators ('Num Lock', 'Caps Lock' and 'Scroll Lock') will now begin to flash in sequence.

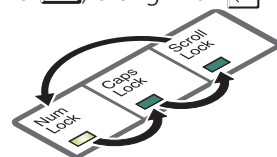
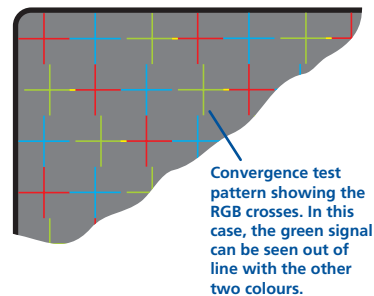
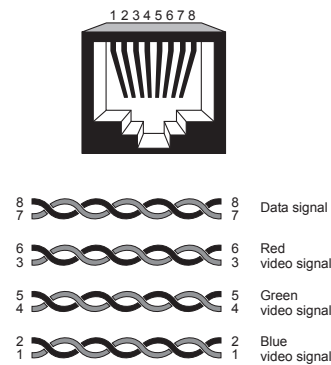

4 As appropriate, press either the R, G or B keyboard keys to select the appropriate colour channel. Corresponding keyboard indicators will flash rapidly to show which channel is currently selected for adjustment: Num Lock for Red, Caps Lock for Green and Scroll Lock for Blue.

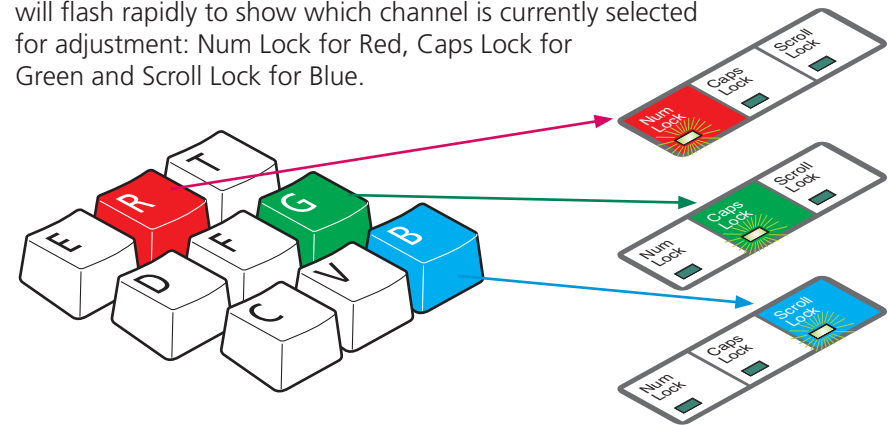

5 Press the **Left Arrow** and **Right Arrow** keys to retard or advance the timing of the selected colour channel respectively. On screen you will see a change in the position of the selected colour crosses in relation to the other two.

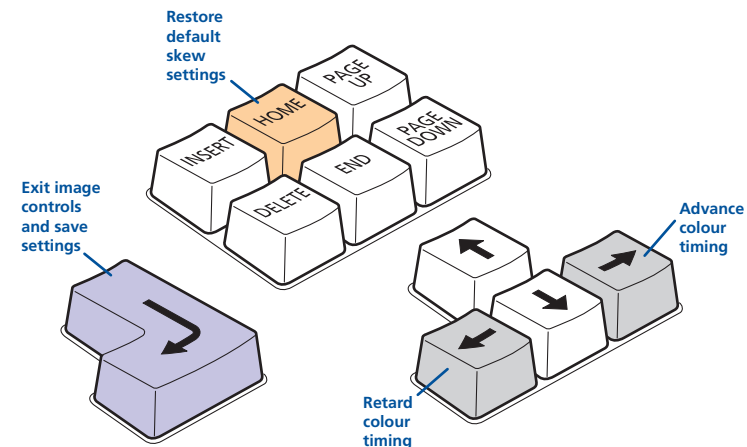

- 6 When the selected colour crosses are correctly positioned, press **F4** to exit that colour channel. The keyboard indicators will return to flashing in sequence.
- 7 If required, repeat steps 4 to 6 to select and adjust any colour channel until the vertical lines of the red, green and blue crosses are all aligned.
- 8 When all colours are correctly aligned, press **F4** to exit configuration mode and permanently save all settings.

*Note: Once you have made a skew adjustment, it may be necessary to re-adjust the image controls to attain an optimum screen image.*



## Miscellaneous settings

The following are configuration settings within the modules that are not covered in other sections of this guide. These can be achieved once within configuration mode by pressing the indicated keys:

### Report Wizard firmware version -

Before initiating this command, ensure that the system is running an application that can display typed keys as screen characters - e.g. a word processor or Windows Notepad. The current firmware version will be written to the application in the form of the letter 'V' followed by three numbers - for example V201 means version 2.01.

### Reset all configuration options to default states -

Returns all user configurable options to the settings that are installed at manufacture. The password will be cleared, however, any current image control settings or skew adjustments will not be reset.



CONTENTS

WELCOME

INSTALLATION  
& OPERATION

SPECIAL  
CONFIGURATION

FURTHER  
INFORMATION

## Flash upgrade

As part of the continual development and improvement process across our range of products, software upgrades are occasionally made available. The LOCAL and REMOTE modules both contain internal flash memory and our unique keyboard-link upgrade technique allow you to utilise software upgrades in a straightforward manner.

*Note: It is important to upgrade both the LOCAL and REMOTE modules together so that they are both running the same new version of software.*

*Note: To upgrade the REMOTE module, a special keyboard connection cable is required. This cable must have 6pin mini-DIN male to 6pin mini-DIN male plugs with all lines connected - this is a common cable used with KVM switches.*

To perform a flash memory upgrade, you need to perform the following stages:

- **Stage A** – Download upgrade files from the website
- **Stage B** – Create a startup diskette and copy the files to it
- **Stage C** – Reconfigure the LOCAL module connections and begin
- **Stage D** – Reconfigure the REMOTE module connections and begin
- **Stage E** – Return all connections to their usual states

## Stage A - Download the upgrade files

### To download the files

- 1 Contact Black Box technical support (see front cover) for details about how to locate and download the appropriate upgrade file.
- 2 Decompress the downloaded file. Depending on the chosen option, there will be a collection of suitable files. As a minimum, there should be the following files:
  - AUTOEXEC.BAT – directs the computer to run the upgrade programs.
  - XKVMV2.EXE – this is the upgrade program that automatically determines which module is connected and sends the appropriate firmware file.
  - XKVM.DAT – this file contains information about firmware versions and is used by the XKVMV2.EXE to select the appropriate one.
  - X2GDLxxx.HEX, X2SLxxx.HEX, X2STLxxx.HEX – these are the firmware files for the LOCAL module.
  - M2GDRxxx.HEX, M2SLRxxx.HEX, M2STRxxx.HEX, S2GDRxxx.HEX, S2SLRxxx.HEX, S2STRxxx.HEX – these are the firmware files for the REMOTE module.

*Where xxx is the upgrade version number.*

*Now please follow Stage B.*

## Stage B - Create a startup diskette

For this stage you will need a 3½ floppy diskette that is either blank or has existing contents that are no longer required. The write protect tab must be moved to the 'unprotected' position. Depending on your operating system, use one of the following to create a startup disk:

### To create a startup disk in Windows XP

- 1 Insert a diskette into the floppy disk drive.
- 2 Select 'Start' and then 'My Computer'.
- 3 Right mouse click on the '3½ Floppy (A:)' icon and select 'Format'.
- 4 Check the 'Create an MS-DOS startup disk' box and select 'Start'.

### To create a startup disk in Windows 95/98/Me

- 1 Insert a formatted diskette into the floppy disk drive.
- 2 Select 'Start', then 'Settings' and then 'Control Panel'.
- 3 Double click on the 'Add/Remove Programs' icon.
- 4 Select the 'Startup Disk' tab.
- 5 Click 'Create Disk' and follow the instructions.

### To create a startup disk in Windows 95/98 (alternative method)

- 1 Insert a diskette into the floppy disk drive.
- 2 Right mouse click on the '3½ Floppy (A:)' icon and select 'Format'.
- 3 Select the 'Full format' option and ensure that the 'Copy system files' box is checked.
- 4 Select 'Start' to format the disk.

### To create a startup disk from MS-DOS or a DOS window within Windows 95/98

- 1 Insert a diskette into the floppy disk drive and check that the drive is configured as drive A (it usually is).
- 2 At the DOS prompt (C:\>) type:

```
FORMAT A: /S
```

and follow the instructions given by DOS.

## Copy the downloaded files to the disk

Once the diskette has been formatted, using Windows Explorer or the My Computer option, copy the downloaded and decompressed files from your computer to the floppy diskette.

*Now please follow Stage C.*



## Stage C - Reconfigure the LOCAL connections and begin

- 1 On the computer from which you will run the upgrade, ensure that its BIOS settings will allow it to boot from the floppy diskette drive, rather than booting immediately from the hard drive.
- 2 Switch off the computer and disconnect the twisted pair cable from the LOCAL module.
- 3 On the multi-cable, leave the keyboard connector attached to the keyboard port of the computer. Disconnect the multi-cable video and mouse connectors from the ports on the computer.
- 4 So that you can check upgrade progress, connect a monitor directly to the video port of the computer.
- 5 On the LOCAL module, change switch 1 to the ON position. Ensure that the upgrade diskette is in the floppy disk drive of the computer.
- 6 Switch on the computer. The upgrade process will start automatically and confirmation will be given on screen.
- 7 Switch off the computer and disconnect the multi-cable. Leave the monitor connected and the upgrade diskette in the floppy disk drive. Return LOCAL switch 1 to the OFF position.

Now please follow Stage D.

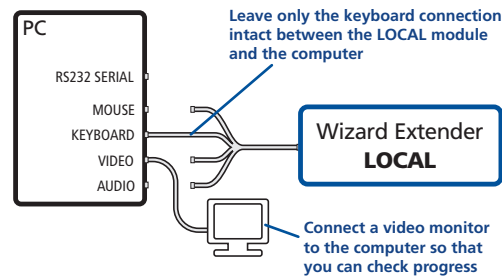

## Stage D - Reconfigure the REMOTE connections and begin

- 1 Disconnect all cables from the REMOTE module and take it to the computer.
- 2 Use a 'KVM switch-type' keyboard cable (6pin mini-DIN male to 6pin mini-DIN male plugs with all lines connected) - not supplied. Attach one end of the cable to the keyboard port of the computer. Connect the other end of the cable to the keyboard port of the REMOTE module. This is the only connection required.
- 3 On the REMOTE module, change switch 1 to the ON position.
- 4 Attach the power supply unit to the POWER input of the REMOTE module and connect the mains lead to a nearby wall socket.
- 5 Switch on the computer. The upgrade process will start automatically and confirmation will be given on screen.
- 6 Switch off the computer and disconnect the REMOTE module. Return REMOTE switch 1 to the OFF position.

Now please follow Stage E.

## Stage E - Return all connections to their usual states

Once the upgrade process has been completed, perform the following to return the system to its previous state.

- 1 Ensure that switch 1 on both the LOCAL and REMOTE modules are set to their OFF positions.
- 2 Refer to the 'Installation and operation' chapter for detailed instructions on correctly connecting the LOCAL and REMOTE modules to the computer, its peripherals, the REMOTE power supply and the twisted pair cable.
- 3 Remove the diskette from the system and reboot. The upgrade process is now complete.

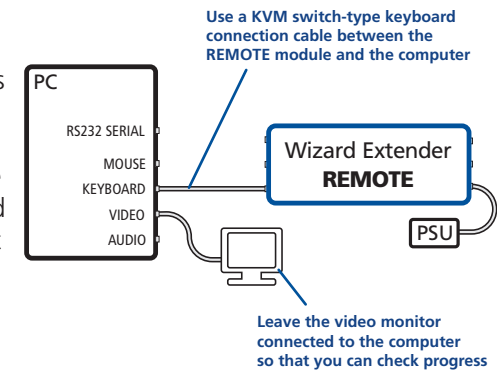



# Further information



## Troubleshooting

If you experience problems when installing or using the Wizard modules, please check through this section for a possible solution. If your problem is not listed here and you cannot resolve the issue, then please refer to the 'Getting assistance' section.

### Video image at the REMOTE module is distorted or shadows appear to the right of displayed objects.

Adjustments are required to compensate for the length of the twisted pair cable being used. If video problems persist:

- Please refer to the 'Image controls - sharpness and brightness' section in the 'Special Configuration' chapter.
- If the overall video image is 'fuzzy' and/or has coloured shadows you may need to make skew adjustments. This procedure allows you to finely tune the red, green and blue video signal timings to overcome most colour separation problems. Please refer to the 'Skew adjustment' section in the 'Special Configuration' chapter.

### No video image is received at the REMOTE module.

- Check that the power/activity indicators are lit on the LOCAL and REMOTE modules - if they are not, then there is a power problem. The ACU5122A LOCAL module gains its power either from the computer's keyboard socket or by using an optional power adapter. The ACU5142A LOCAL module requires power from its supplied power adapter.

When keys are pressed or the mouse is moved, check that the indicators flicker – if they do not respond then there could be a twisted pair link problem or a problem with one of the modules.

- Check that multiple link cables are correctly connected only between the corresponding ports on the LOCAL and REMOTE modules and do not cross over to other ports.
- Check that each link cable is wired correctly as per the diagram in the 'Skew adjustment' section in the 'Special Configuration' chapter.
- If possible, try using an alternative twisted pair link connection between the modules. Ensure that all of the link cables are of the same length and have the same twist characteristics - it is not possible to adjust only one video channel, they are all adjusted together.

- If the sharpness control is set too high, the monitor may not be able to display a picture. Try reinstating the factory default sharpness settings. Please refer to the 'Image controls - sharpness and brightness' section in the 'Special Configuration' chapter.
- Temporarily disconnect the video link to the LOCAL module, connect a monitor directly to the computer video port and check for a correct video image output.

### The keyboard indicators are flashing between the Caps Lock and the Num Lock/Scroll Lock and the computer does not respond to any keyboard or mouse inputs.

- The modules are currently locked and require a valid password to be entered. Please refer to the section 'Locking and unlocking the system' for details.

### Power is applied via the power supply but the REMOTE module operation has stopped.

- Each module has an internal automatic cut-out fuse to protect against power surges. To reset, remove power from the module for one second and then reconnect.

### The on-screen mouse pointer does not respond to mouse movements

- The mouse connection may have been interrupted. Either, reboot the system and re-power the REMOTE module power supply, or try using the mouse restoration command. Please refer to the 'Hot plugging and mouse restoration' section in the 'Special Configuration' chapter.

### Sound from the microphone cannot be heard or is very quiet

- Check the setting of LOCAL switch 3 - if a microphone is connected at the REMOTE module, the switch should be set OFF.

### Sound input from the stereo line input is distorted ('tinny' sounding) and only one channel is working

- Check the setting of LOCAL switch 3 - if a stereo line input is connected at the REMOTE module, the switch should be set ON.

## Getting assistance

If you are still experiencing problems after checking the list of solutions in the Troubleshooting section then please refer to the customer support information supplied on the front cover.

CONTENTS

WELCOME

INSTALLATION  
& OPERATION

SPECIAL  
CONFIGURATION

FURTHER  
INFORMATION

## Other products in the Wizard range

The following related Wizard items are available:

- **Wizard Extender ACU5013A**

Allows one system to be controlled from two locations or permits a second video channel to be sent to a remote location. Used in conjunction with two receiver/remote modules ACU5111A.

- **Rack mount chassis ACU5000A**

This 19" chassis allows multiple Wizard modules to be neatly arranged within a standard cabinet. Securing plates and screws are supplied separately for each Wizard module for use with the rack mount chassis.

- **Power distribution module PS5000**

Provides power for up to four Wizard modules to reduce mains power socket requirements.

- **Rack mount securing plates**

- single slot blanking plate ACU5003
- quad slot blanking plate ACU5004

## Safety information

- For use in dry, oil free indoor environments only.
- Do not use to link between buildings.
- Ensure that the twisted pair interconnect cable is installed in compliance with all applicable wiring regulations.
- Do not connect the CATx link interface (RJ45 style connector) to any other equipment, particularly network or telecommunications equipment.
- Warning – the power adapter contains live parts.
- No user serviceable parts are contained within the power adapter - do not dismantle.
- Plug the power adapter into a socket outlet close to the Wizard unit that it is powering.
- Replace the power adapter with a manufacturer approved type only.
- Do not use the power adapter if the power adapter case becomes damaged, cracked or broken or if you suspect that it is not operating properly.
- If you use a power extension cord with the extenders, make sure the total ampere rating of the devices plugged into the extension cord do not exceed the cord's ampere rating. Also, make sure that the total ampere rating of all the devices plugged into the wall outlet does not exceed the wall outlet's ampere rating.
- Do not attempt to service the Wizard modules yourself.
- The Wizard modules and power supplies can get warm in operation – do not situate them in an enclosed space without any ventilation.
- The Wizard modules do not provide ground isolation and should not be used for any applications that require ground isolation or galvanic isolation.



CONTENTS

WELCOME

INSTALLATION  
& OPERATION

SPECIAL  
CONFIGURATION

FURTHER  
INFORMATION

## Radio Frequency Energy

A Category 5 (or better) twisted pair cable must be used to connect the modules in order to maintain compliance with radio frequency energy emission regulations and ensure a suitably high level of immunity to electromagnetic disturbances.

All other interface cables used with this equipment must be shielded in order to maintain compliance with radio frequency energy emission regulations and ensure a suitably high level of immunity to electromagnetic disturbances.

## European EMC directive 89/336/EEC



This equipment has been tested and found to comply with the limits for a class A computing device in accordance with the specifications in the European standard EN55022. These limits are designed to provide reasonable protection against harmful interference. This equipment generates, uses and can

radiate radio frequency energy and if not installed and used in accordance with the instructions may cause harmful interference to radio or television reception. However, there is no guarantee that harmful interference will not occur in a particular installation. If this equipment does cause interference to radio or television reception, which can be determined by turning the equipment on and off, the user is encouraged to correct the interference with one or more of the following measures: (a) Reorient or relocate the receiving antenna. (b) Increase the separation between the equipment and the receiver. (c) Connect the equipment to an outlet on a circuit different from that to which the receiver is connected. (d) Consult the supplier or an experienced radio/TV technician for help.

## FCC Compliance Statement (United States)

This equipment generates, uses and can radiate radio frequency energy and if not installed and used properly, that is, in strict accordance with the manufacturer's instructions, may cause interference to radio communication. It has been tested and found to comply with the limits for a class A computing device in accordance with the specifications in Subpart J of part 15 of FCC rules, which are designed to provide reasonable protection against such interference when the equipment is operated in a commercial environment. Operation of this equipment in a residential area may cause interference, in which case the user at his own expense will be required to take whatever measures may be necessary to correct the interference. Changes or modifications not expressly approved by the manufacturer could void the user's authority to operate the equipment.

## Canadian Department of Communications RFI statement

This equipment does not exceed the class A limits for radio noise emissions from digital apparatus set out in the radio interference regulations of the Canadian Department of Communications.

*Le présent appareil numérique n'émet pas de bruits radioélectriques dépassant les limites applicables aux appareils numériques de la classe A prescrites dans le règlement sur le brouillage radioélectriques publié par le ministère des Communications du Canada.*



CONTENTS

WELCOME

INSTALLATION  
& OPERATION

SPECIAL  
CONFIGURATION

FURTHER  
INFORMATION

# Certification notice for equipment used in Canada

The Canadian Department of Communications label identifies certified equipment. This certification means that the equipment meets certain telecommunications-network protective, operation, and safety requirements.

The Department does not guarantee the equipment will operate to the user's satisfaction.

Before installing this equipment, users should ensure that it is permissible to be connected to the facilities of the local telecommunications company.

The equipment must also be installed using an acceptable method of connection. In some cases, the company's inside wiring associated with a single-line individual service may be extended by means of a certified connector assembly (extension cord). The customer should be aware that compliance with the above conditions may not prevent degradation of service in some situations.

Repairs to certified equipment should be made by an authorized Canadian maintenance facility—in this case, your supplier. Any repairs or alterations made by the user to this equipment, or equipment malfunctions, may give the telecommunications company cause to request the user to disconnect the equipment.

Users should ensure for their own protection that the electrical ground connections of the power utility, telephone lines, and internal metallic water pipe system, if present, are connected together. This precaution may be particularly important in rural areas.

## CAUTION:

Users should not attempt to make such connections themselves, but should contact the appropriate electric inspection authority, or electrician, as appropriate.

The LOAD NUMBER (LN) assigned to each terminal device denotes the percentage of the total load to be connected to a telephone loop which is used by the device, to prevent overloading. The termination on a loop may consist of any combination of devices, subject only to the requirement that the total of the load numbers of all the devices does not exceed 100.



CONTENTS

WELCOME

INSTALLATION  
& OPERATION

SPECIAL  
CONFIGURATION

FURTHER  
INFORMATION

# Normas Oficiales Mexicanas (NOM) electrical safety statement



## Instrucciones de seguridad

- 1 Todas las instrucciones de seguridad y operación deberán ser leídas antes de que el aparato eléctrico sea operado.
- 2 Las instrucciones de seguridad y operación deberán ser guardadas para referencia futura.
- 3 Todas las advertencias en el aparato eléctrico y en sus instrucciones de operación deben ser respetadas.
- 4 Todas las instrucciones de operación y uso deben ser seguidas.
- 5 El aparato eléctrico no deberá ser usado cerca del agua—por ejemplo, cerca de la tina de baño, lavabo, sótano mojado o cerca de una alberca, etc.
- 6 El aparato eléctrico debe ser usado únicamente con carritos o pedestales que sean recomendados por el fabricante.
- 7 El aparato eléctrico debe ser montado a la pared o al techo sólo como sea recomendado por el fabricante.
- 8 Servicio—El usuario no debe intentar dar servicio al equipo eléctrico más allá a lo descrito en las instrucciones de operación. Todo otro servicio deberá ser referido a personal de servicio calificado.
- 9 El aparato eléctrico debe ser situado de tal manera que su posición no interfiera su uso. La colocación del aparato eléctrico sobre una cama, sofá, alfombra o superficie similar puede bloquea la ventilación, no se debe colocar en libreros o gabinetes que impidan el flujo de aire por los orificios de ventilación.
- 10 El equipo eléctrico deber ser situado fuera del alcance de fuentes de calor como radiadores, registros de calor, estufas u otros aparatos (incluyendo amplificadores) que producen calor.
- 11 El aparato eléctrico deberá ser conectado a una fuente de poder sólo del tipo descrito en el instructivo de operación, o como se indique en el aparato.
- 12 Precaución debe ser tomada de tal manera que la tierra física y la polarización del equipo no sea eliminada.
- 13 Los cables de la fuente de poder deben ser guiados de tal manera que no sean pisados ni pellizcados por objetos colocados sobre o contra ellos, poniendo particular atención a los contactos y receptáculos donde salen del aparato.
- 14 El equipo eléctrico debe ser limpiado únicamente de acuerdo a las recomendaciones del fabricante.
- 15 En caso de existir, una antena externa deberá ser localizada lejos de las líneas de energía.
- 16 El cable de corriente deberá ser desconectado del cuando el equipo no sea usado por un largo periodo de tiempo.
- 17 Cuidado debe ser tomado de tal manera que objetos líquidos no sean derramados sobre la cubierta u orificios de ventilación.
- 18 Servicio por personal calificado deberá ser provisto cuando:
  - A: El cable de poder o el contacto ha sido dañado; u
  - B: Objetos han caído o líquido ha sido derramado dentro del aparato; o
  - C: El aparato ha sido expuesto a la lluvia; o
  - D: El aparato parece no operar normalmente o muestra un cambio en su desempeño; o
  - E: El aparato ha sido tirado o su cubierta ha sido dañada.

CONTENTS

WELCOME

INSTALLATION  
& OPERATION

SPECIAL  
CONFIGURATION

FURTHER  
INFORMATION

## BlackBox subsidiary contact details



Country	Web Site/Email	Phone	Fax
United States	www.blackbox.com	724-746-5500	724-746-0746
United Kingdom	www.blackbox.co.uk techhelp@blackbox.co.uk	+44 118 965 6000	+44 118 965 6001
Austria	www.black-box.at support@black-box.at	+43 1 256 98 56	+43 1 256 98 56
Belgium	www.blackbox.be support.nederlands@blackbox.be support.french@blackbox.be support.english@blackbox.be	+32 2 725 85 50	+32 2 725 92 12
Denmark	www.blackbox.dk blackbox@blackbox.dk	+32 2 725 85 50	+32 2 725 92 12
Finland	www.blackbox.fi tuki@blackbox.fi	+35 201 888 800	+35 201 888 808
France	www.blackbox.fr tech@blackbox.fr	+33 1 45 606 717	+33 1 45 606 747
Germany	www.black-box.de techsupp@black-box.de	+49 811 5541 110	+49 811 5541 499
Ireland	www.blackbox.co.uk techhelp@blackbox.co.uk	+353 1 662 2466	+353 1 662 2477
Italy	www.blackbox.it supporto.tecnico@blackbox.it	+39 02 27 404 700	+39 02 27 400 219
Netherlands	www.blackbox.nl techsupport@blackbox.nl	+31 30 241 7799	+31 30 241 4746
Norway	www.blackboxnorge.no support@blackboxnorge.no	+47 55 300 710	+47 55 300 701
Spain	www.blackbox.es tecnico@blackbox.es	+34 9162590732	+34 916239784
Sweden	www.blackboxab.se support@blackboxab.se	+46 8 44 55 890	+46 08 38 04 30
Switzerland	www.black-box.ch support@black-box.ch	+41 55 451 70 71	+41 55 451 70 75

CONTENTS

WELCOME

INSTALLATION  
& OPERATION

SPECIAL  
CONFIGURATION

FURTHER  
INFORMATION



© 2005 Black Box Corporation  
All trademarks are acknowledged.

Black Box Corporation,  
1000 Park Drive,  
Lawrence,  
PA 15055-1018,  
United States of America  
Tel: +1-724-746-5500  
Fax: +1-724-746-0746

Black Box Network Services (UK) Ltd,  
464 Basingstoke Road,  
Reading,  
Berkshire, RG2 0BG,  
United Kingdom  
Tel: +44 (0)118 965 5100

CONTENTS

WELCOME

INSTALLATION  
& OPERATION

SPECIAL  
CONFIGURATION

FURTHER  
INFORMATION

Documentation by:



[www.ctxd.com](http://www.ctxd.com)



© Copyright 2005. Black Box Corporation. All rights reserved.

---

1000 Park Drive • Lawrence, PA 15055-1018 • 724-746-5500 • Fax 724-746-0746