



© Copyright 1995. Black Box Corporation. All rights reserved.

1000 Park Drive • Lawrence, PA 15055-1018 • 724-746-5500 • Fax 724-746-0746



JUNE 1995

IC237A

IC486A

IC482A

IC487A-F

Non-Powered Interface Converters

RS-232 to RS-530

RS-422 to V.35

RS-232 to RS-485

RS-232 to RS-422/RS-449

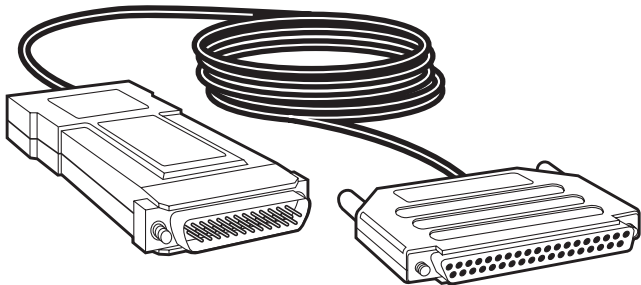

CUSTOMER SUPPORT INFORMATION

Order **toll-free** in the U.S. 24 hours, 7 A.M. Monday to midnight Friday: **877-877-BBOX**

FREE technical support, 24 hours a day, 7 days a week: Call **724-746-5500** or fax **724-746-0746**

Mail order: **Black Box Corporation**, 1000 Park Drive, Lawrence, PA 15055-1018

Web site: www.blackbox.com • E-mail: info@blackbox.com

Contents

Chapter	Page
1. Specifications.....	1
1.1 IC237A.....	1
1.2 IC482A.....	2
1.3 IC486A.....	4
1.4 IC487A-F.....	6
2. Introduction	8
2.1 IC237A.....	9
2.2 IC482A.....	10
2.3 IC486A.....	11
2.4 IC487A-F.....	13
3. Installation.....	14
3.1 IC237A.....	14
3.2 IC482A.....	18
3.3 IC486A.....	19
3.4 IC487A-F.....	24

1. Specifications

1.1 IC237A

Interface A — RS-232/V.24/V.28, DTE/DCE selectable

Connectors — DB25 male

Distance — Direct connection to RS-232/V.24 device

Interface B — RS-530 (RS-422), DTE/DCE selectable

Connectors — DB25 female

Distance — Direct connection to RS-530 device

Transmission Format — Synchronous/asynchronous, transparent to protocol

Data Rates — Up to 200 Kbps

Cable — 6.5 ft. (2 m)

Input Voltage — Standard RS-232/V.24 driver ±12 volts

NON-POWERED INTERFACE CONVERTERS

Operating Temperature —	32° to 122°F (0° to 50°C)
Humidity —	Up to 90%, noncondensing
Power —	No AC power required
Size —	0.9"H x 2.1"W x 4.3"D (2.3 x 5.3 x 10.9 cm)
Weight —	14 oz. (397 g), including cable and connector

1.2 IC482A

Interface A —	V.35, DTE only
<i>Connectors</i> —	V.35 (M-block) male
<i>Distance</i> —	Direct connection to V.35 device
Interface B —	RS-449/V.36/V.11 (RS-422), DCE only
<i>Connectors</i> —	DB37 female
<i>Distance</i> —	Direct connection to RS-449/V.36 device

Transmission Format —	Synchronous, transparent to protocol
Data Rates —	Up to 2.048 Mbps
Cable —	6.5 ft. (2 m)
Input Voltage —	Standard RS-422 and V.35 drivers
Operating Temperature —	32° to 122°F (0° to 50°C)
Humidity —	Up to 90%, noncondensing
Power —	No AC power required
Size —	0.9"H x 2.1"W x 4.3"D (2.3 x 5.3 x 10.9 cm)
Weight —	14 oz. (397 g), including cable and connector

NON-POWERED INTERFACE CONVERTERS

1.3 IC486A

Interface A —	RS-232, DCE
<i>Connectors</i> —	DB25F
<i>Distance</i> —	Direct connection to RS-232 device
Interface B —	RS-422/485
<i>Connectors</i> —	(5) screw terminals
<i>Distance</i> —	Up to 3.75 miles (6 km)
Transmission Format —	Asynchronous only (data transparent)
Transmission Mode —	Full duplex on 4-wire, half- duplex on 2- or 4-wire
Control Signals —	Request to Send (pin 4): Controls transmit carrier, only if Carrier switch is in the CNTRL switch position); Clear to Send (pin 5): Set by CTS switches to be either open, high or delayed, after RTS; Data Set Ready (pin 6) and

Data Carrier Detect (pin 8):
Both are set by the DCD+DSR
switch to be either high or
open; Data Terminal Ready
(pin 20): Should be connected
for power considerations only,
to constantly on (high).

**Carrier
Control —**

The Carrier is strap-selectable
to be either continuously on
or switched by RTS.

Data Rates —

Up to 38.4 Kbps

Input Voltage —

Derived from data and control
or external 6- to 12-VDC 50 mA

**Operating
Temperature —**

32° to 122°F (0° to 50°C)

Humidity —

Up to 90%, noncondensing

Power —

Derived from data and control
signals. If signal power is
insufficient, a 6- to 12-VDC
50-mA external power supply
is required. (Call your supplier
for more information.)

NON-POWERED INTERFACE CONVERTERS

Size — 0.9"H x 2.1"W x 4.3"D
(2.3 x 5.3 x 10.9 cm)

Weight — 3 oz. (85 g)

1.4 IC487A-F

Interface A — RS-232/V.24/V.28, DTE/DCE
selectable

Connectors — DB25 male

Distance — Direct connection to
RS-232/V.24 device

Interface B — RS-449/V.36 (RS-422),
DTE/DCE selectable

Connectors — DB37 female

Distance — Direct connection to
RS-449/V.36 device

**Transmission
Format** —

Synchronous, transparent to
protocol

Data Rates — Up to 200 Kbps

NON-POWERED INTERFACE CONVERTERS

Cable —	6.5 ft. (2 m)
Input Voltage —	Standard RS-232/V.24 driver ±12 volts
Operating Temperature —	32° to 122°F (0° to 50°C)
Humidity —	Up to 90%, noncondensing
Power —	No AC power required
Size —	0.9"H x 2.1"W x 4.3"D (2.3 x 5.3 x 10.9 cm)
Weight —	14 oz. (397 g), including cable and connector

2. Introduction

The Non-Powered Interface Converters enable connection between DTE and DCE data- communications equipment with different interfaces. The Converters perform both the physical and electrical conversion between the two interfaces. The circuitry is designed to provide short-range interface conversion.

NOTE

The devices that are to be connected must be within 6 feet (2 m) of each other. If greater distances are required, then an active powered converter must be used.

The Converters operate without AC power, using ultra-low power from the DTE and DCE equipment's data and control signals. **Sections 2.1** through **2.4** provide descriptions and typical applications for each Converter.

2.1 IC237A

RS-232 to RS-530 (Model No. IC237A) is used for converting between V.24/RS-232 and RS-530 interfaces. It's switch-selectable and is used either for connecting a V.24/RS-232 DTE to an RS-530 DCE, or for connecting a V.24/RS-232 DCE to an RS-530 DTE.

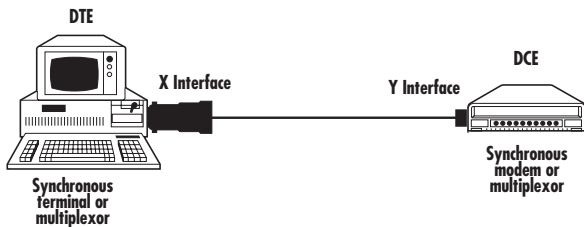

Fig. 2-1. X and Y interfaces are V.24 (RS-232) and RS-530.

NOTE

The DCE/DTE setting should be set to the type of unit to be connected to, not what the IC237A is to look like.

2.2 IC482A

RS-422 to V.35 (Model No. IC482A) is used for connecting a V.35 DCE device to an RS-422/449/V.36 DTE device.

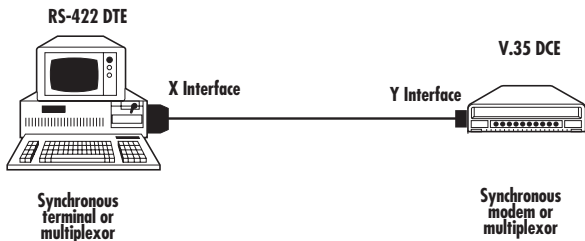

Fig. 2-2. X interface is RS-422; Y interface is V.35 only.

2.3 IC486A

The RS-232 to RS-485 (Model No. IC486A) converts between RS-232/V.24 DTE devices and RS-485 equipment. It also enables multipoint connection of a computer and terminals in a mixed V.24 and RS-485 environment. (See Fig. 2-4.)

This Converter's carrier can be strapped to be constantly on or can be controlled by the Request to Send signal. Operation with controlled carrier enables connection in a multipoint configuration. The receive pair impedance is selectable for Low (120 ohm) or High (12 k Ω).

To ensure proper operation of the RS-232 to RS-485 Converter, the DTE device should provide the following signals: RTS (pin 4) and DTR (pin 20). If these signals are not available or if they do not provide enough power, then a powered converter is required. (Call your supplier for more information about the IC108A and IC109A.)

NON-POWERED INTERFACE CONVERTERS

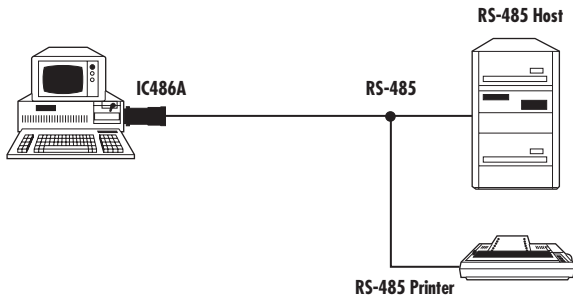

Fig. 2-3. Interface converter, V.24/RS-232 to RS-485.

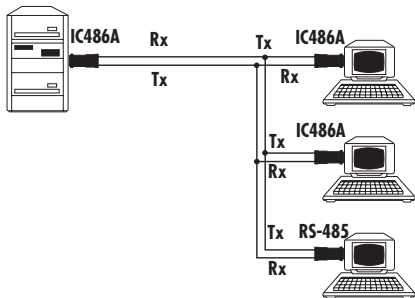

Fig. 2-4. Short-range modem in a multipoint environment.

2.4 IC487A-F

RS-232 to RS-422/RS-449 (Model No. IC487A-F) is used to convert between V.24/RS-232 and V.36/RS-422 interfaces. It's switch-selectable either for connecting a V.24/RS-232 DTE to a V.36/RS-442 DCE, or for connecting a V.24 DCE to a V.36 DTE.

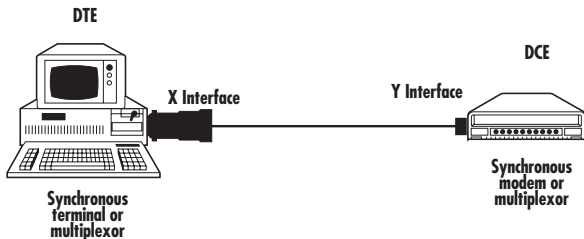

Fig. 2-5. X and Y interfaces can be V.24 (RS-232) and V.36.

NOTE

When setting DTE/DCE options, the setting applies to the type of interface connecting to, not what the converter appears as.

3. Installation

3.1 IC237A

The Converter plugs directly into the DTE and the DCE. Connect the Converter directly to the RS-232/V.24 device, and the cable connector to the RS-530 device.

The Converter comes factory-strapped for RS-232 DTE/RS-530 DCE, as shown in Figure 3-1. To change this configuration:

1. Separate the two parts of the plastic cover by pressing the marked places on the sides, starting at the cable end.
2. Remove the 40-pin DTE/DCE socket by gently grasping both sides and slowly moving it from side to side, while pulling up.
3. Turn the socket around and replace it so that the DCE faces the RS-232 connector and the DTE faces the RS-530 device (see Figure 3-2). Make sure the pins are aligned with the socket.

NOTE

The DTE/DCE setting is set for the type of device connecting to, not what the converter is, as is illustrated in Figures 3-3 and 3-4.

4. Close the unit by pressing the two plastic covers together.

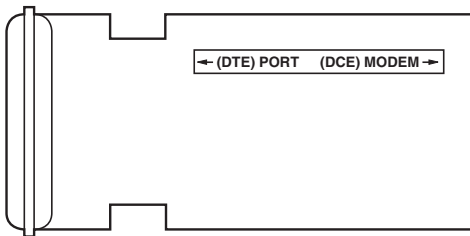

Fig. 3-1. RS-232 DTE, RS-530 DCE.

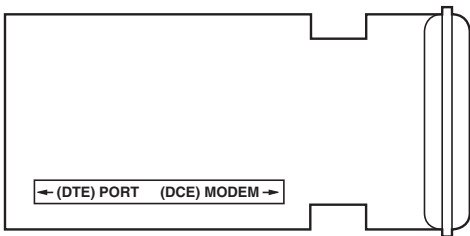

Fig. 3-2. RS-530 DTE, RS-232 DCE.

3.2 IC482A

Installation is simple and straightforward. The Converter plugs directly into the DTE or DCE. No strapping adjustments are required. Connect the 37-pin connector to the RS-449/V.36 device and the other connector to the V.35 device, and it's ready to operate.

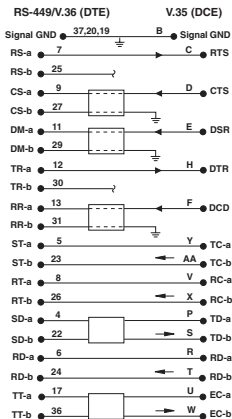

Fig. 3-5. RS-449 (V.36) DTE/V.35 DCE Schematic Diagram.

NOTE

When selecting DTE/DCE options, the setting applies to the type of interface connecting to, not what the converter appears as.

3.3 IC486A

1. Separate the two parts of the plastic cover by firmly pressing the marked places on the sides, starting at the cable end. Connect the RS-485 line to the Converter as follows:



NOTE

The A and B transmit and receive lines are as defined in RS-485. According to this definition A is negative with respect to B for mark and A is positive with respect to B for space. If the RS-485 equipment connecting to is labeled TX+, TX-, etc., connect the plus leads to the “B” connections, and the minus leads to the “A” connections.

For 2-wire operation, two small jumper wires must be used to connect TA to RA (this will connect to the minus line) and TB to RB (this will connect to the plus line).

NOTE

On the unit, up (≠) indicates ON and down (∅) indicates OFF.

2. Set the internal switches according to Table 3-1.
3. Chassis GND: To connect the chassis ground (pin 1 or RS-232) to signal ground (pin 7 of RS-232), set chassis GND to CON. To disconnect, set to DIS (factory setting).
4. Close the unit by pressing the two halves of the cover together.
5. Power is normally derived from the data and control signals. To ensure proper operation, the DTE should provide the following signals, using standard V.24/RS-232 drivers at ± 12 volts:

TD (pin 2), RTS (pin 4), and DTR (pin 20).

If some signals are not available, or if they do not provide enough power, a powered converter must be used. (Call your supplier for more information on products IC108A and IC109A.)

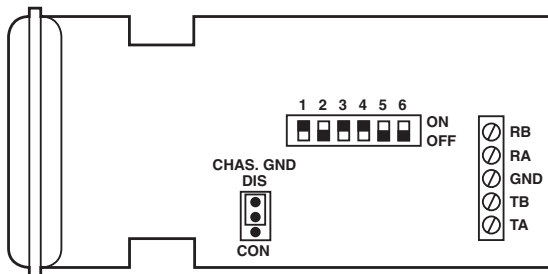

Fig. 3-6. Strapping Diagram for the IC486A.

NON-POWERED INTERFACE CONVERTERS

Table 3-1. Switch Selection

Switch Identity	Function	Possible Positions	Dfn.	Factory Setting
DCD+DSR (SW1)	Both signals high. Both signals disconnected.	<u>SW1</u> ON	ON	ON
		OFF	NC	
CTS Status and RTS to CTS Delay (SW2, 3, 4)	CTS not provided. CTS always high. CTS follows RTS. CTS follows RTS. Illegal position! Do not use!	<u>SW2</u> <u>SW3</u> <u>SW4</u> OFF OFF X	NC	20 msec
		ON OFF X	ON	
		OFF ON OFF	0 msec	
		OFF ON ON	20 msec	
		ON ON X	Fault	
Carrier (SW5)	Carrier controlled by RTS. Carrier always ON.	<u>SW5</u> ON	CNTRL	CNTRL
		OFF	ON	
Note: Carrier (SW5) must be in CNTRL position for 2-wire operation.				
Receive Impedance (SW6)	Low High	<u>SW6</u> ON	120Ω	OFF
		OFF	12 kΩ	
Note: For point-to-point connection, the receive impedance should be set to Low. For multipoint connection, the master and terminating units should be set to Low and all the other units to High.				

Table 3-2. Optional Connectors

Signal Name	RJ-11 Jack		RJ-45 Jack	
	Pin No.	Color	Pin No.	Color
Signal Ground	1, 6	Blue/Brown	1, 7	
Transmit A	2	Black	3	
Transmit B	5	Yellow	6	
Receive A	3	Red	4	
Receive B	4	Green	5	

Table 3-3. Approximate Range (When Used as a Short-Range Modem)

Data Rate	24 AWG (0.5 mm)
1200	10 km
2400	8 km
9600	6 km
19200	4 km

(The line is terminated with 100 ohms at both ends.)

3.4 IC487A-F

The Converter plugs directly into the DCE and the DTE. Connect the Converter directly to the RS-232/V.24 device, and the cable connector to the RS-449 device. The Converter comes factory-strapped for RS-232 DTE/RS-449 DCE, as shown in Figure 3-7. To change this configuration:

1. Separate the two parts of the plastic cover by pressing the marked places on the sides, starting at the cable end.
2. Remove the 40-pin DTE/DCE socket by gently grasping both sides and slowly moving it from side to side, while pulling up.
3. Turn the socket around and replace it so that the DCE faces the RS-232 connector and the DTE faces the RS-449 device (see Figure 3-8). Make sure that the pins are aligned with the socket.

NOTE

When setting DTE/DCE options, the setting applies to the type of interface connecting to, not what the converter appears as.

4. Close the unit by pressing the two plastic covers together.

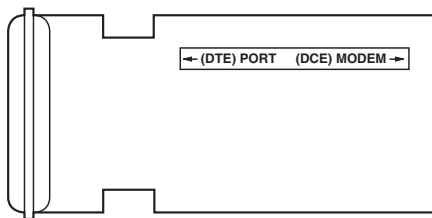

Fig. 3-7. RS-232 DTE, RS-449 DCE (V.24 DTE, V.36 DCE).

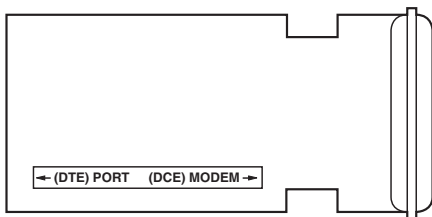

Fig. 3-8. RS-449 DTE, RS-232 DCE (V.36 DTE, V.24 DCE).

NON-POWERED INTERFACE CONVERTERS

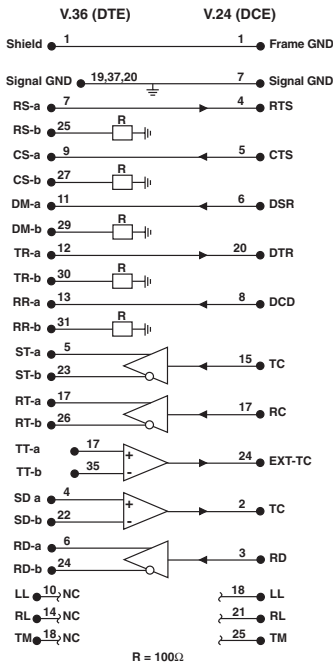

Fig. 3-9. RS-449 (V.36) DTE/RS-232 (V.24) DCE Schematic Diagram.

