

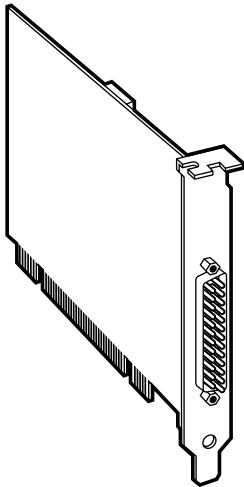

# RS-232/422/485 Single-Port PCI Card, Opto-Isolated



---

## CUSTOMER SUPPORT INFORMATION

Order **toll-free** in the U.S.: Call **877-877-BBOX** (outside U.S. call **724-746-5500**)

FREE technical support 24 hours a day, 7 days a week: Call **724-746-5500** or fax **724-746-0746**

Mailing address: **Black Box Corporation**, 1000 Park Drive, Lawrence, PA 15055-1018

Web site: [www.blackbox.com](http://www.blackbox.com) • E-mail: [info@blackbox.com](mailto:info@blackbox.com)

**FEDERAL COMMUNICATIONS COMMISSION  
and INDUSTRY CANADA  
RADIO FREQUENCY INTERFERENCE STATEMENTS**

*Class B Digital Device.* This equipment has been tested and found to comply with the limits for a Class B computing device pursuant to Part 15 of the FCC Rules. These limits are designed to provide reasonable protection against harmful interference in a residential installation. However, there is no guarantee that interference will not occur in a particular installation. This equipment generates, uses, and can radiate radio frequency energy, and, if not installed and used in accordance with the instructions, may cause harmful interference to radio communications. If this equipment does cause harmful interference to radio or telephone reception, which can be determined by turning the equipment off and on, the user is encouraged to try to correct the interference by one of the following measures:

- Reorient or relocate the receiving antenna.
- Increase the separation between the equipment and receiver.

- Connect the equipment into an outlet on a circuit different from that to which the receiver is connected.
- Consult an experienced radio/TV technician for help.

**CAUTION**

Changes or modifications not expressly approved by the party responsible for compliance could void the user's authority to operate the equipment.

To meet FCC requirements, shielded cables and power cords are required to connect this device to a personal computer or other Class B certified device.

*This digital apparatus does not exceed the Class B limits for radio noise emission from digital apparatus set out in the Radio Interference Regulation of Industry Canada.*

*Le présent appareil numérique n'émet pas de bruits radioélectriques dépassant les limites applicables aux appareils numériques de classe B prescrites dans le Règlement sur le brouillage radioélectrique publié par Industrie Canada.*

**EUROPEAN UNION DECLARATION OF CONFORMITY**

This equipment complies with the requirements of the European EMC Directive 89/336/EEC.



**NORMAS OFICIALES MEXICANAS (NOM)  
ELECTRICAL SAFETY STATEMENT**

**INSTRUCCIONES DE SEGURIDAD**

1. Todas las instrucciones de seguridad y operación deberán ser leídas antes de que el aparato eléctrico sea operado.
2. Las instrucciones de seguridad y operación deberán ser guardadas para referencia futura.
3. Todas las advertencias en el aparato eléctrico y en sus instrucciones de operación deben ser respetadas.
4. Todas las instrucciones de operación y uso deben ser seguidas.
5. El aparato eléctrico no deberá ser usado cerca del agua—por ejemplo, cerca de la tina de baño, lavabo, sótano mojado o cerca de una alberca, etc..
6. El aparato eléctrico debe ser usado únicamente con carritos o pedestales que sean recomendados por el fabricante.
7. El aparato eléctrico debe ser montado a la pared o al techo sólo como sea recomendado por el fabricante.
8. Servicio—El usuario no debe intentar dar servicio al equipo eléctrico más allá a lo descrito en las instrucciones de operación. Todo otro servicio deberá ser referido a personal de servicio calificado.
9. El aparato eléctrico debe ser situado de tal manera que su posición no interfiera su uso. La colocación del aparato eléctrico sobre una cama, sofá, alfombra o superficie similar puede bloquea la ventilación, no se debe colocar en libreros o gabinetes que impidan el flujo de aire por los orificios de ventilación.

10. El equipo eléctrico deber ser situado fuera del alcance de fuentes de calor como radiadores, registros de calor, estufas u otros aparatos (incluyendo amplificadores) que producen calor.
11. El aparato eléctrico deberá ser connectado a una fuente de poder sólo del tipo descrito en el instructivo de operación, o como se indique en el aparato.
12. Precaución debe ser tomada de tal manera que la tierra fisica y la polarización del equipo no sea eliminada.
13. Los cables de la fuente de poder deben ser guiados de tal manera que no sean pisados ni pellizcados por objetos colocados sobre o contra ellos, poniendo particular atención a los contactos y receptáculos donde salen del aparato.
14. El equipo eléctrico debe ser limpiado únicamente de acuerdo a las recomendaciones del fabricante.
15. En caso de existir, una antena externa deberá ser localizada lejos de las líneas de energia.
16. El cable de corriente deberá ser desconectado del cuando el equipo no sea usado por un largo periodo de tiempo.
17. Cuidado debe ser tomado de tal manera que objetos liquidos no sean derramados sobre la cubierta u orificios de ventilación.
18. Servicio por personal calificado deberá ser provisto cuando:
  - A: El cable de poder o el contacto ha sido dañado; u
  - B: Objetos han caído o líquido ha sido derramado dentro del aparato; o
  - C: El aparato ha sido expuesto a la lluvia; o
  - D: El aparato parece no operar normalmente o muestra un cambio en su desempeño; o
  - E: El aparato ha sido tirado o su cubierta ha sido dañada.

## **TRADEMARKS USED IN THIS MANUAL**

IBM and PS/2 are registered trademarks of International Business Machines Corporation.

Windows and Windows NT are either registered trademarks or trademarks of Microsoft Corporation in the United States and other countries.

*Any other trademarks mentioned in this manual are acknowledged to be the property of the trademark owners.*

# Contents

<b>Chapter</b>	<b>Page</b>
1. Specifications . . . . .	9
2. Introduction . . . . .	10
2.1 Overview . . . . .	10
2.2 What the Package Includes . . . . .	11
2.3 Factory-Default Settings . . . . .	12
2.4 Technical Description . . . . .	12
2.5 Connector Pin Assignments . . . . .	13
3. Card Setup . . . . .	14
3.1 Electrical Interface Selection . . . . .	14
3.2 Line Termination . . . . .	16
3.3 RS-485 Enable Modes . . . . .	17
3.4 Clock Modes . . . . .	19
3.5 Baud Rates and Divisors for D1 Mode . . . . .	19
4. Installation . . . . .	21
4.1 Operating System Installation . . . . .	21
4.1.1 For Windows Users . . . . .	21
4.1.2 Other Operating Systems . . . . .	21
4.2 System Installation . . . . .	21



## Contents (continued)

<b>Chapter</b>	<b>Page</b>
Appendix A. Troubleshooting . . . . .	23
A.1 Tips . . . . .	23
A.2 Calling Black Box. . . . .	24
A.3 Shipping and Packaging . . . . .	25
Appendix B. Electrical Interfaces . . . . .	26
B.1 RS-232 . . . . .	26
B.2 RS-422 . . . . .	27
B.3 RS-485 . . . . .	28
Appendix C. Ground Loop Phenomenon . . . . .	30
C.1 What is Ground Loop? . . . . .	30
C.2 Cabling Recommendations. . . . .	30
Appendix D. Asynchronous Communication . . . . .	32
Appendix E. Board Layout. . . . .	35

# 1. Specifications

**UART:** 16850

**Speed:** RS-422/485: Up to 460.8 kbps

**Maximum Distance:** RS-422: Up to 4000 ft. (1219.2 m)

**MTBF:** Greater than 150,000 hours (calculated)

**Interface:** RS-232/422/485, Opto-Isolated

**Connectors:** (1) DB25 male

**Indicators:** None

**Temperature Tolerance:** *Operating:* 32 to 122°F (0 to 50°C); *Storage:* -4 to +158°F (-20 to +70°C)

**Relative Humidity:** 10 to 90%, noncondensing

**Power:** +5 VDC or +3.3 VDC PCI expansion, 480 mA

**Size:** 2.2"H x 4.7"W (5.6 x 11.9 cm), excluding goldfingers; 2.5"H x 4.7"W (6.4 x 11.9 cm), including goldfingers

**Weight:** 3.3 oz. (93.6 g)

## 2. Introduction

### 2.1 Overview

The RS-232/422/485 Single-Port PCI Card, Opto-Isolated is a single-channel isolated PCI Bus serial I/O adapter for PCs and compatibles. Using a 16850 UART with its industry-leading 128-byte FIFOs, it provides a field-selectable RS-232/422/485 serial port that supports data rates up to 460.8 kbps (RS-422/485).

Configure the PCI card as RS-232 for standard serial COM: port requirements. Choose the RS-422 mode for long-distance device connections up to 4000 ft. (1219.2 m), where noise immunity and high data integrity are essential. Select RS-485 and capture data from multiple peripherals in an RS-485 multidrop network. Up to 31 RS-485 devices can be connected to each port to automate your data collection. You can even mix the ports in any of the interface combinations to provide maximum flexibility to your application. Optional DB25 to terminal block adapters (part number IC980) are available to simplify field-wiring connections.

In both RS-232 and RS-422 modes, the card works seamlessly with the standard operating system serial driver. In RS-485 mode, our special auto-enable feature allows the RS-485 ports to be viewed by the operating system as a COM: port. This means that the standard COM: driver can be used for RS-485 communications. Our on-board hardware automatically handles the RS-485 driver enable.

## **2.2 What the Package Includes**

The PCI card is shipped with the following items.

- (1) RS-232/422/485 Single-Port PCI Card.
- (1) Serial Utilities CD-ROM containing drivers for Windows® 3.1x/95/98/2000 and Windows NT®, Advanced COM drivers, utilities, INF files, help files, and this users' manual in PDF format.

If either item is missing or damaged, contact Black Box at 724-746-5500.

## **2.3 Factory-Default Settings**

When shipped from the factory, the PCI card's DB25 port is configured as RS-422.

To install the PCI card using factory-default settings, refer to **Chapter 4**.

## **2.4 Technical Description**

The RS-232/422/485 Single-Port PCI Card, Opto-Isolated provides a PCI interface adapter with an isolated asynchronous serial port that gives you a versatile interface, field-selectable as RS-232 for modems, printers and plotters, as well as RS-422/485 for industrial automation and control applications. Isolation is important in installations where the equipment being connected to the PC is either far from the PC or on a different power transformer circuit. Ground loop current is a commonly neglected and misunderstood phenomenon that leads to data loss and the destruction of communications interfaces.

The PCI card uses the 16850 UART. This chip features programmable baud rates, data format, interrupt control, and industry-leading 128-byte FIFOs.

## 2.5 Connector Pin Assignments

Table 2-1. RS-232 signals (DB25 male).

Signal	Name	Pin #	Mode
GND	Ground	7	—
RD	Receive Data	3	Input
CTS	Clear To Send	5	Input
TD	Transmit Data	2	Output
RTS	Request To Send	4	Output

### NOTE

These assignments meet EIA/TIA/ANSI-232E DTE standards.

### TECHNICAL NOTE

Please terminate any control signals that are not going to be used. The most common way to do this is to connect RTS to CTS and RI. Also, connect DCD to DTR and DSR. Terminating these pins, if not used, will help ensure that you get the best performance from your adapter.

Table 2-2. RS-422/485/530 pin assignments (DB25 male).

Signal	Name	Pin #	Mode
GND	Ground	7	—
RDB	RX+ Receive Data Positive	16	Input
RDA	RX- Receive Data Negative	3	Input
CTSB	CTS+ Clear To Send Positive	13	Input
CTSA	CTS- Clear To Send Negative	5	Input
TDB	TX+ Transmit Data Positive	14	Output
TDA	TX- Transmit Data Negative	2	Output
RTSB	RTS+ Request To Send Positive	19	Output
RTSA	RTS- Request To Send Negative	4	Output

## 3. Card Setup

### 3.1 Electrical Interface Selection

The RS-232/422/485 Single-Port PCI Card can be used as RS-232, RS-422, or RS-485. This is selectable via DIP-switch SW1. Please use the following examples to configure your PCI card.

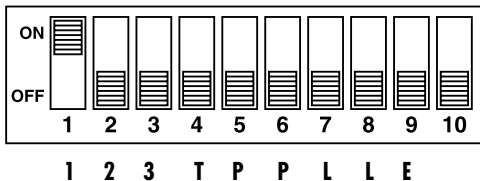

Figure 3-1. RS-232.

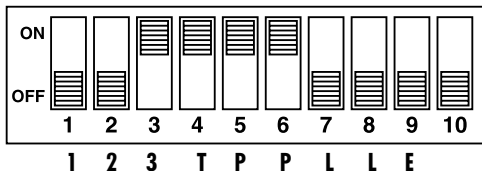

Figure 3-2. RS-422.

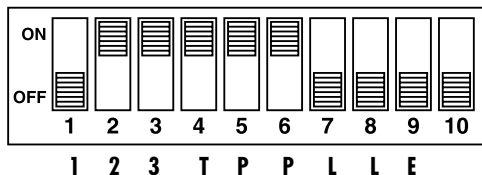

Figure 3-3. RS-485 4-wire with echo.

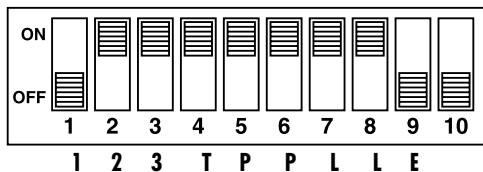

Figure 3-4. RS-485 2-wire with echo.

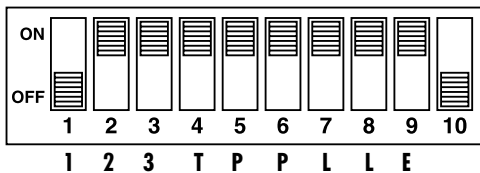

Figure 3-5. RS-485 2-wire without echo.



### 3.2 Line Termination

Typically, each end of the RS-485 bus must have line-terminating resistors (RS-422 terminates at the receive end only). A 120-ohm resistor is across each RS-422/485 input in addition to a 1K ohm pull-up/pull-down combination that biases the receiver inputs. Switches SW1 and SW2 allow the user to customize this interface to his/her specific requirements. Each switch position corresponds to a specific portion of the interface. If multiple PCI cards are configured in an RS-485 network, only the boards on each end should have jumpers T, P, and P on. Refer to Table 3-1 for each position's operation.

**Table 3-1. Jumper settings.**

<b>Name</b>	<b>Function</b>
T	Adds or removes the 120-ohm termination.
P	Adds or removes the 1K ohm pull-down resistor in the RS-422/RS-485 receiver circuit (Receive data only).
P	Adds or removes the 1K ohm pull-up resistor in the RS-422/RS-485 receiver circuit (Receive data only).
L	Connects the TX+ to RX+ for RS-485 two-wire operation.
L	Connects the TX- to RX- for RS-485 two-wire operation.

### 3.3 RS-485 Enable Modes

RS-485 is ideal for multi-drop or network environments. RS-485 requires a tri-state driver that will allow the electrical presence of the driver to be removed from the line. The driver is in a tri-state or high impedance condition when this occurs. Only one driver may be active at a time and the other driver(s) must be tri-stated. The output modem control signal Request To Send (RTS) is typically used to control the state of the driver. Some communication software packages refer to RS-485 as RTS Enable or RTS block mode transfer.

One of the unique features of the PCI card is the ability to be RS-485 compatible without the need for special software or drivers. This ability is especially useful in operating systems where the lower-level I/O control is abstracted from the application program. You can effectively use the PCI card in an RS-485 application with existing (that is, standard RS-232) software drivers.

Switch SW2 is used to control the RS-485 mode functions for the driver circuit (see Figure 3-6). The selections are RTS Enable (silk-screen “RT,” switch position 4) or Auto Enable (silk-screen “AT,” switch position 3). The Auto Enable feature automatically

## RS-232/422/485 SINGLE-PORT PCI CARD, OPTO-ISOLATED

enables/disables the RS-485 interface. The RTS mode uses the RTS modem control signal to enable the RS-485 interface and provides backward compatibility with existing software products.

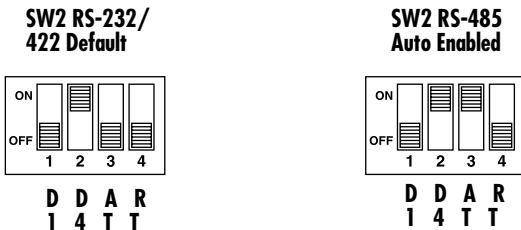

Figure 3-6. RS-485 enable modes.

The RS-485 Echo is the result of connecting the receiver inputs to the transmitter outputs. Every time a character is transmitted, it is also received. This can be beneficial if the software can handle echoing (that is, using received characters to throttle the transmitter) or it can confuse the system if the software does not. Position 9 of SW1 is used to control the RS-485 enable/disable functions for the receiver circuit. To select the No Echo mode, place switch position 9 to the On position (see Figure 3-5).

### 3.4 Clock Modes

The PCI card uses a unique clocking option that lets you select from “divide by 4” and “divide by 1” clocking modes. These modes are selected at switches SW-2.

To select the baud rates commonly associated with COM: ports (that is, 2400, 4800, 9600, 19.2, ... 115.2 kbps), set switch-position 2 to the On position (silk-screen D4). To select the maximum data rate (460.8 kbps), set switch-position 1 to the On position (silk-screen D1).



Figure 3-7. Clocking modes.

### 3.5 Baud Rates and Divisors for D1 Mode

Table 3-2 (on the next page) shows some common data rates and the rates you should choose to match them if using the PCI card in D1 mode.

**Table 3-2. Baud rates.**

<b>For this Data Rate</b>	<b>Choose this Data Rate</b>
1200 bps	300 bps
2400 bps	600 bps
4800 bps	1200 bps
9600 bps	2400 bps
19.2 kbps	4800 bps
57.6 kbps	14.4 kbps
115.2 kbps	28.8 kbps
230.4 kbps	57.6 kbps
460.8 kbps	115.2 kbps

If your communications package allows the use of baud rate divisors, choose the appropriate divisor from Table 3-3.

**Table 3-3. Baud rate divisors.**

<b>For this Data Rate</b>	<b>Choose this Divisor</b>
1200 bps	384
2400 bps	192
4800 bps	96
9600 bps	48
19.2 kbps	24
38.4 kbps	12
57.6 kbps	8
115.2 kbps	4
230.4 kbps	2
460.8 kbps	1

## 4. Installation

### 4.1 Operating System Installation

#### 4.1.1 FOR WINDOWS USERS

Start by choosing **Install Software** at the beginning of the CD. Choose **Asynchronous COM: Port Software, SeaCOM**.

#### 4.1.2 OTHER OPERATING SYSTEMS

Refer to the appropriate section of the Serial Utilities Software.

### 4.2 System Installation

The RS-232/422/485 Single-Port PCI Card, Opto-Isolated can be installed in any of the PCI expansion slots and contains several jumper straps for each port that must be set for proper operation.

1. Turn off PC power. Disconnect the power cord.
2. Remove the PC case cover.
3. Locate an available PCI slot and remove the blank metal slot cover.

## RS-232/422/485 SINGLE-PORT PCI CARD, OPTO-ISOLATED

4. Gently insert the PCI card into the slot. Make sure that the card is seated properly.
5. Replace the screw.
6. Replace the cover.
7. Connect the power cord.

Installation is complete.

# Appendix A. Troubleshooting

## A.1 Tips

Using the supplied software and following these simple steps can eliminate most common problems.

1. Identify all I/O adapters currently installed in your system. This includes your on-board serial ports, controller cards, sound cards, etc. The I/O addresses used by these adapters, as well as the IRQ (if any) should be identified.
2. Configure your PCI card so that there is no conflict with currently installed adapters. No two adapters can occupy the same I/O address.
3. Make sure the PCI card is using a unique IRQ. While the card does allow the sharing of IRQs, many other adapters (that is, SCSI adapters and on-board serial ports) do not. The IRQ is typically selected via an on-board header block. Refer to **Chapter 3** for help in choosing an I/O address and IRQ.
4. Make sure the PCI card is securely installed in a motherboard slot.



5. When running DOS or Windows 3.x, refer to the supplied software and this manual to verify that the PCI card is configured correctly. This software contains an easy-to-use diagnostic program (SSD) that will verify if a card is configured properly.
6. For Windows 95/98/Me/2000 and Windows NT, the diagnostic tool “WinSSD” is installed in the SeaCOM folder on the Start Menu during the setup process. First find the ports using the Device Manager, then use “WinSSD” to verify that the ports are functional.
7. Always use the systems diagnostic software when troubleshooting a problem. This will eliminate any software issues.

If none of the above steps solved the problem, please refer to **Section A.2**.

## **A.2 Calling Black Box**

If you determine that your RS-232/422/485 Single-Port PCI Card, Opto-Isolated is malfunctioning, do not attempt to alter or repair the unit. It contains no user-serviceable parts. Contact Black Box at 724-746-5500.

Before you do, make a record of the history of the problem. We will be able to provide more efficient and accurate assistance if you have a complete description, including:

- the nature and duration of the problem.
- when the problem occurs.
- the components involved in the problem.
- any particular application that, when used, appears to create the problem or make it worse.

### **A.3 Shipping and Packaging**

If you need to transport or ship your RS-232/422/485 Single-Port PCI Card, Opto-Isolated:

- Package it carefully. We recommend that you use the original container.
- If you are shipping the RS-232/422/485 Single-Port PCI Card, Opto-Isolated for repair, make sure you include everything that came in the original package. Before you ship, contact Black Box to get a Return Authorization (RA) number.

## **Appendix B. Electrical Interfaces**

### **B.1 RS-232**

Quite possibly the most widely used communication standard is RS-232. This implementation has been defined and revised several times and is often referred to as RS-232 or EIA/TIA-232. The IBM® PC computer defined the RS-232 port on a DB9 connector, and subsequently the EIA/TIA approved this implementation as the EIA/TIA-574 standard. This standard is defined as the 9-Position Non-Synchronous Interface between Data Terminal Equipment and Data Circuit-Terminating Equipment Employing Serial Binary Data Interchange. Both implementations are in wide-spread use and will be referred to as RS-232 in this document.

RS-232 is capable of operating at data rates up to 20 kbps at distances less than 50 ft (15.2 m). The absolute maximum data rate may vary due to line conditions and cable lengths. RS-232 is a single-ended or unbalanced interface, meaning that a single electrical signal is compared to a common signal (ground) to determine binary logic states. The RS-232 and the EIA/TIA-574 specification define two types of interface circuits: DTE and DCE. The PCI card is a DTE device.

## B.2 RS-422

The RS-422 specification defines the electrical characteristics of balanced voltage digital interface circuits. RS-422 is a differential interface that defines voltage levels and driver/receiver electrical specifications. On a differential interface, logic levels are defined by the difference in voltage between a pair of outputs or inputs. In contrast, a single-ended interface (such as RS-232) defines the logic levels as the difference in voltage between a single signal and a common ground connection. Differential interfaces are typically more immune to noise or voltage spikes that may occur on the communication lines. Differential interfaces also have greater drive capabilities that allow for longer cable lengths. RS-422 is rated up to 10 Mbps and can have cabling 4000 feet (1219.2 m) long. RS-422 also defines driver and receiver electrical characteristics that will allow one driver and up to 32 receivers on the line at once. RS-422 signal levels range from 0 to +5 volts. RS-422 does not define a physical connector.

### **B.3 RS-485**

RS-485 is backward compatible with RS-422; however, it is optimized for partyline or multi-drop applications. The output of the RS-422/485 driver is capable of being Active (enabled) or Tri-State (disabled). This capability allows multiple ports to be connected in a multi-drop bus and selectively polled. RS-485 allows cable lengths up to 4000 feet (1219.2 m) and data rates up to 10 Mbps. The signal levels for RS-485 are the same as those defined by RS-422. RS-485 has electrical characteristics that allow for 32 drivers and 32 receivers to be connected to one line. This interface is ideal for multi-drop or network environments. RS-485 tri-state driver (not dual-state) will allow the electrical presence of the driver to be removed from the line. Only one driver may be active at a time and the other driver(s) must be tri-stated. RS-485 can be cabled in two ways, two-wire and four-wire mode. Two-wire mode does not allow for full-duplex communication, and requires that data be transferred in only one direction at a time. For half-duplex operation, the two transmit pins should be connected to the two receive pins (Tx+ to Rx+ and Tx- to Rx-). Four-wire mode allows full-duplex data transfers. RS-485 does not define a connector pinout or a set of

modem control signals. RS-485 does not define a physical connector.

## **Appendix C. Ground Loop Phenomenon**

### **C.1 What is Ground Loop?**

Ground loop phenomenon occurs when two (or more) pieces of equipment are connected together with a common ground, and a different ground potential exists at each location. This current can cause the connected equipment to experience noise that, in turn, causes data transmission errors. In the extreme, this ground current can cause equipment malfunction or even destruction.

### **C.2 Cabling Recommendations**

When connecting the PCI card in an RS-485 network, make sure that both ends of the network are not isolated from ground (see Figure C-1). This “floating” ground condition could cause the capacitive or inductive coupling of voltages that will cause a breakdown in the DC to DC converter circuit or in the opto-isolator circuit. This condition will cause data errors and possibly destroy the receiver circuit.

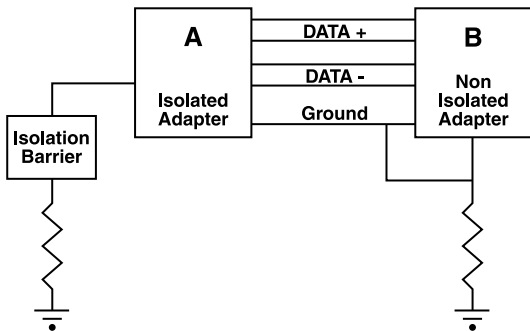

Figure C-1. PCI card cabling example.



## **Appendix D. Asynchronous Communication**

Serial data communication implies that individual bits of a character are transmitted consecutively to a receiver that assembles the bits back into a character. Data rate, error checking, handshaking, and character framing (start/stop bits) are pre-defined and must correspond at both the transmitting and receiving ends.

Asynchronous communication is the standard means of serial data communication for PC compatibles and PS/2® computers. The original PC was equipped with a communication (COM:) port that was designed around an 8250 Universal Asynchronous Receiver Transmitter (UART). This device allows asynchronous serial data to be transferred through a simple and straightforward programming interface. A start bit, followed by a pre-defined number of data bits (5, 6, 7, or 8) defines character boundaries for asynchronous communication. The end of the character is defined by the transmission of a pre-defined number of stop bits (usually 1, 1.5, or 2). An extra bit used for error detection is often appended before the stop bits.

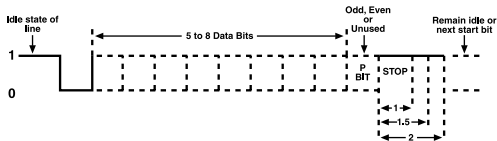

**Figure D-1. Asynchronous communication bit diagram.**

This special bit is called the parity bit. Parity is a simple method of determining if a data bit has been lost or corrupted during transmission. There are several methods for implementing a parity check to guard against data corruption. Common methods are called (E)ven Parity or (O)dd Parity. Sometimes parity is not used to detect errors on the data stream. This is referred to as (N)o parity. Because each bit in asynchronous communication is sent consecutively, it is easy to generalize asynchronous communication by stating that each character is wrapped (framed) by pre-defined bits to mark the beginning and end of the serial transmission of the character. The data rate and communication parameters for asynchronous communication have to be the same at both the

## **RS-232/422/485 SINGLE-PORT PCI CARD, OPTO-ISOLATED**

transmitting and receiving ends. The communication parameters are baud rate, parity, number of data bits per character, and stop bits (that is, 9600, N, 8, 1).

## Appendix E. Board Layout

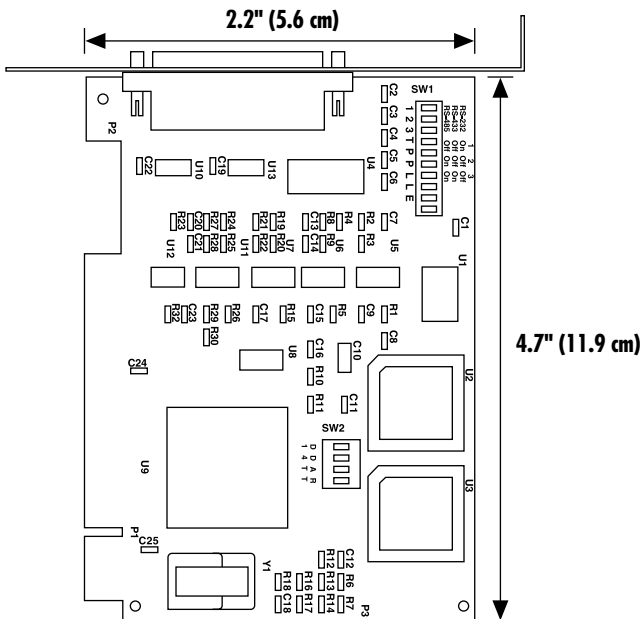



© Copyright 2004. Black Box Corporation. All rights reserved.

---

1000 Park Drive • Lawrence, PA 15055-1018 • 724-746-5500 • Fax 724-746-0746