

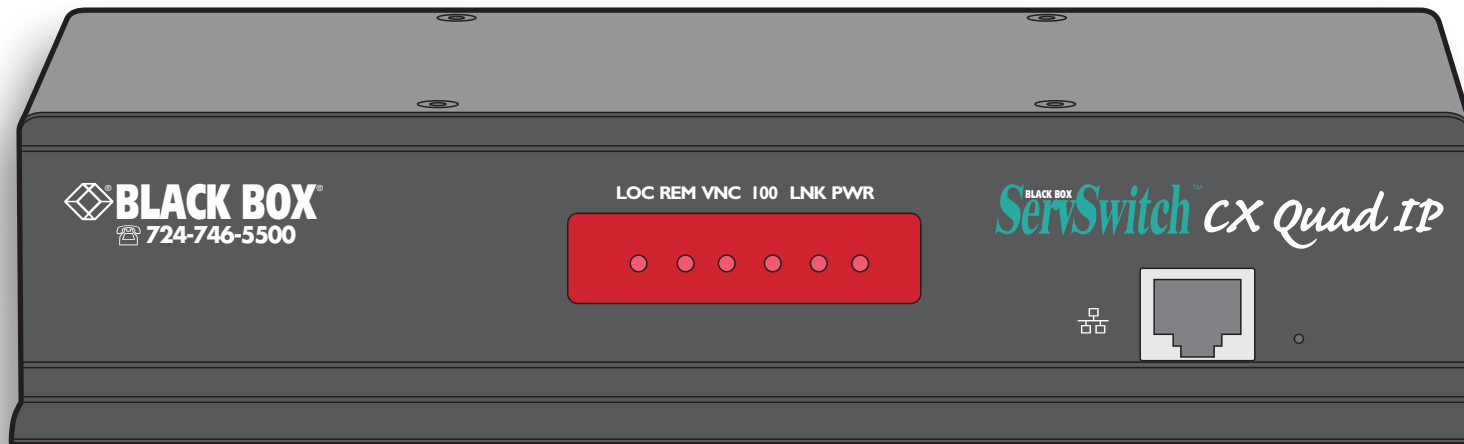

ServSwitch™ CX Quad IP

USER GUIDE



**CUSTOMER
SUPPORT
INFORMATION**

Order **toll-free** in the U.S.: Call **877-877-BBOX** (outside U.S. call **724-746-5500**)
FREE technical support 24 hours a day, 7 days a week: Call **724-746-5500** or fax **724-746-0746**
Mailing address: **Black Box Corporation**, 1000 Park Drive, Lawrence, PA 15055-1018
Web site: www.blackbox.com • E-mail: info@blackbox.com

CONTENTS

Contents



Introduction

Welcome	4
Creating larger installations	5
Cascade installations.....	5
Enterprise installations.....	5
ServSwitch CX Quad IP features - front and rear	6
What's in the box.....	7
What you may additionally need	7

Installation

Mounting	8
Connections	9
Local user.....	10
Global users (IP network port)	11
Computer system (via SAM)	12
Power in connection.....	13
Power control port	14
Multiple video head connections	15
Remote switching control	16

Configuration

Overall initial configuration	17
Initial configuration	18
Main menu.....	19
General security and configuration steps.....	20
Registering users and host computers	20
What to do if the ADMIN password has been forgotten	21
Clearing IP access control	22
Full configuration by global user	23
Encryption settings.....	24
Networking issues.....	25
Power switching configuration	29
Upgrading ServSwitch CX Quad IP models	30
Recovering from a failed upgrade.....	30

INSTALLATION



CONFIGURATION

OPERATION

FURTHER
INFORMATION

INDEX

Operation

The front panel indicators	31
Accessing the ServSwitch CX Quad IP.....	31
Local user access	32
Selecting a computer	32
Show All Users.....	34
Logging in and out.....	34
The confirmation (status) box.....	35
User preferences and functions	35
Orange dot indicators in the Select Host menu.....	36
Global user access.....	37
Global user access via VNC viewer	38
Global user access via web browser.....	39
Using the viewer window	40
The menu bar	40
When using the viewer window	40
Mouse pointers.....	41
Host selection	41
Configure.....	41
Auto calibrate 	42
Re-synchronize mouse 	42
Access mode - shared/private	42
Power switching	42
Controls.....	43
VNC hotkey selection	47
If you need to enter a port number.....	48
Viewer encryption settings.....	48
Supported web browsers.....	48

Further information

Getting assistance.....	49
Troubleshooting	49
Appendix 1 – Local setup menus	50
Functions	51
User Preferences	52
Global Preferences.....	53
Setup Options	54
Configuration.....	55
Unit Configuration.....	56
Network Configuration	57
Serial Configuration.....	58
Reset Configuration	59
Appendix 2 - Configuration pages via viewer	60
User accounts	61
Unit configuration	62
Advanced unit configuration	63
Time & date configuration	64
Network configuration.....	65
Setting IP access control.....	66
Serial port configuration.....	67
Host configuration.....	68
Logging and status	69
LDAP configuration	70



INSTALLATION
CONFIGURATION
OPERATION
FURTHER INFORMATION
INDEX

Appendix 3 - VNC viewer connection options	71
Colour/Encoding	71
Inputs	72
Misc	73
Scaling	74
Identities	75
Load / Save	75
Appendix 4 - VNC viewer window options	76
Appendix 5 - Browser viewer options	77
Encoding and colour level	77
Inputs	77
Security	77
Misc	77
Appendix 6 – Addresses, masks and ports	78
IP addresses	78
Net masks	78
Net masks - the binary explanation	79
Calculating the mask for IP access control	80
Ports	81
Security issues with ports	81

Appendix 7 – Cascading multiple units	82
Connecting units in cascade	83
Addressing computers in a cascade	84
Using cascaded computers	84
Appendix 8 – Cable and connector specifications	85
ServSwitch CX Quad IP to power switch cable	85
Power switch to power switch daisy chain cable	85
Multi-head synchronisation cable	85
Appendix 9 – Hotkey sequence codes	86
Permissible key presses	86
Creating macro sequences	86
Appendix 10 – Supported video modes	87
Safety information	88
End user licence agreement	89
Radio Frequency Energy	90
Normas Oficiales Mexicanas (NOM)	91
Instrucciones de seguridad	91

Index

BlackBox subsidiary contact details	95
---	----



Introduction



Thank you for choosing the ServSwitch CX Quad IP from Black Box. This compact unit allows one local user plus four global users (located anywhere that has a network/internet connection) to view and take full control of multiple host computer systems.

Each global user simply requires a Real VNC client application which is supplied on CD and can also be downloaded from various locations, even from the ServSwitch CX Quad IP unit itself. Alternatively, the unit can quickly serve a Java applet to a global user, requiring only a standard internet browser to operate.

Like the other models within the highly successful ServSwitch CX family, this unit takes full advantage of category 5, 5e or 6 structured cabling to provide flexible installation and configuration. Every connected computer is linked by up to ten metres of standard CATx cable and one of five types of SAM (Server Access Module) according to the port arrangements on each computer.

The ServSwitch CX Quad IP can directly support up to sixteen computers, however, this total can be increased to a maximum of 256 by adding ServSwitch CX Uno units in cascade to provide a much larger network

of controlled computers. All ServSwitch CX models provide full enterprise level security to restrict access to authorized personnel.

A copy of the WIZARD.NET application is included within the package. This useful utility allows you to quickly and efficiently manage user groups and their access permissions across multiple devices such as the ServSwitch CX Quad IP.

Optional power switch control allows you to remotely perform a hard reset on any host system, no matter how badly it may have locked up.

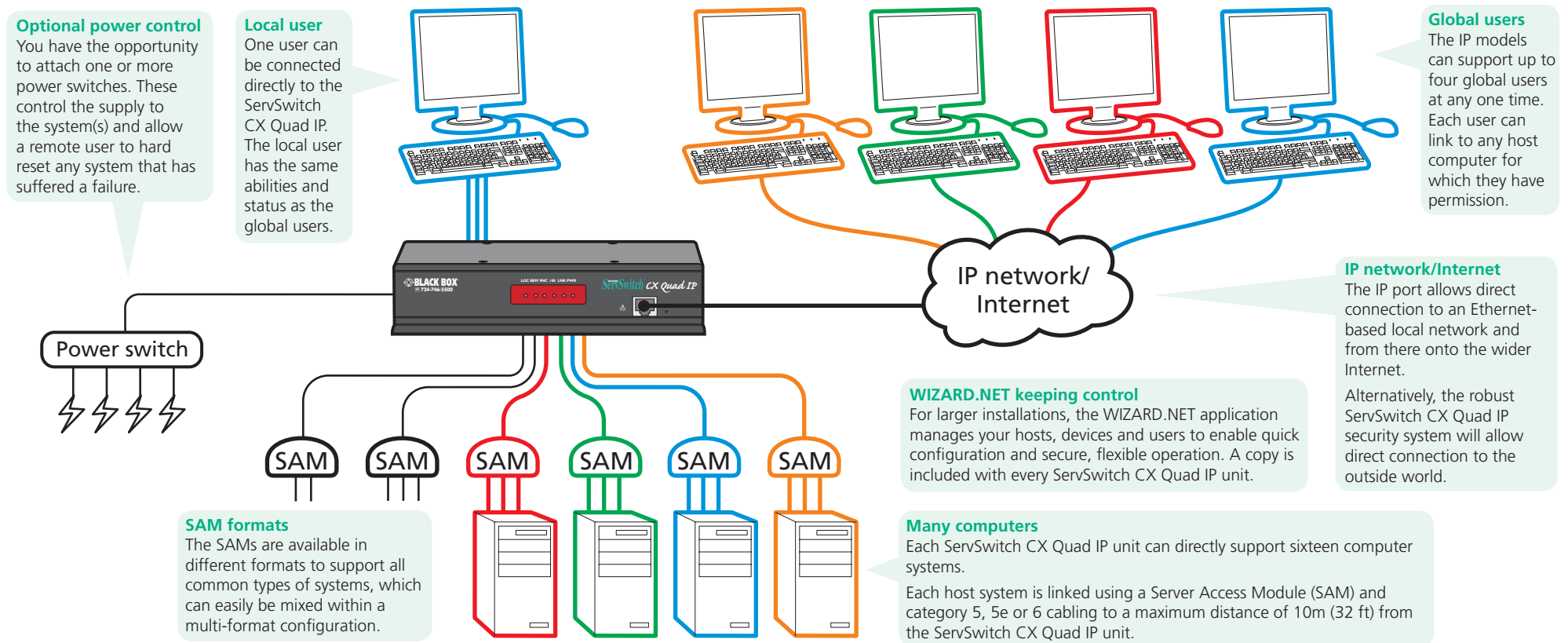

INSTALLATION

CONFIGURATION

OPERATION

FURTHER INFORMATION

INDEX

Creating larger installations

Alone, the ServSwitch CX Quad IP can support sixteen host computers and allow up to five users (four global and one local) to concurrently access any of those hosts. In many cases the number of hosts will exceed these numbers and that is when the flexibility of the ServSwitch CX range becomes apparent.

There are two main ways to increase the number of supported host computers:

- **Cascade:** Connect ServSwitch CX Uno units to the ports of the master ServSwitch CX Quad IP, then connect the host computers to the 'Uno' units.
- **Enterprise:** Add further ServSwitch CX Quad IP units and spread the hosts between them.

Cascade installations

Cascade installations can support a maximum of 256 host computers, however, they impose the limitation that only a single host can be viewed by users at any time. For more details see [Appendix 7 - Cascading multiple units](#).

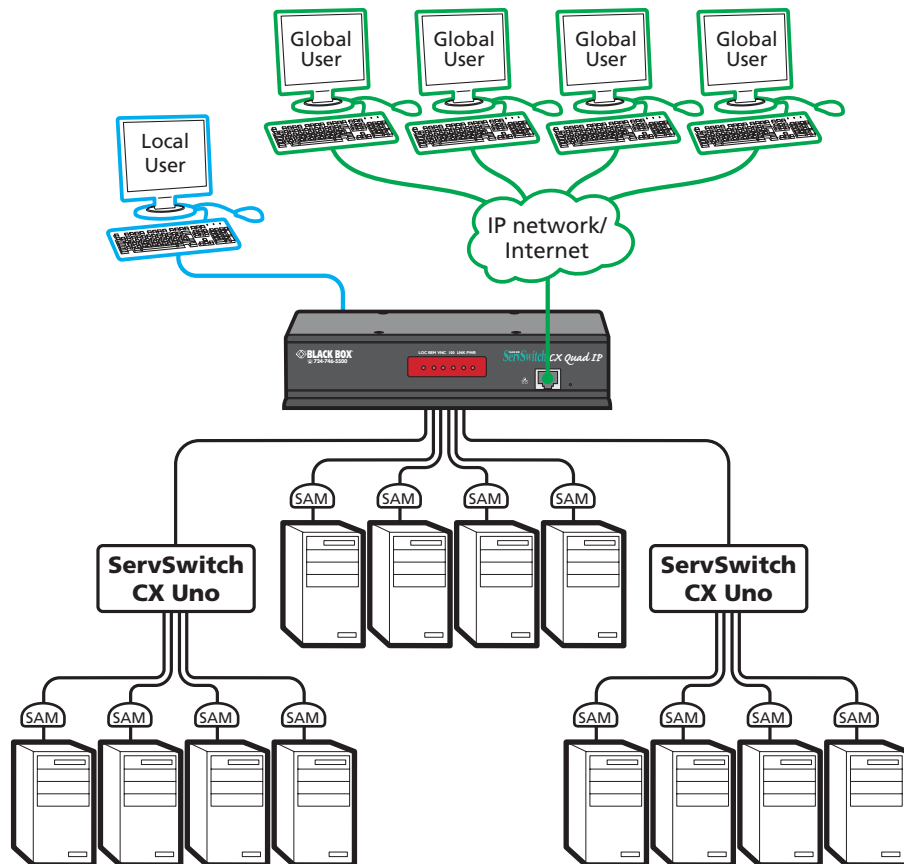

Enterprise installations

Enterprise installations are effectively limitless, you can keep adding ServSwitch CX Quad IP units and new hosts whenever and wherever required. For all but the most basic enterprise configurations, the supplied WIZARD.NET utility becomes vitally important: For users, it provides a virtualized and seamless way to access host systems that are spread across multiple devices. For administrators, it creates a centralized and secure method for managing all of those hosts, devices and users. For further information, please see the user manual on the supplied WIZARD.NET CD-ROM.

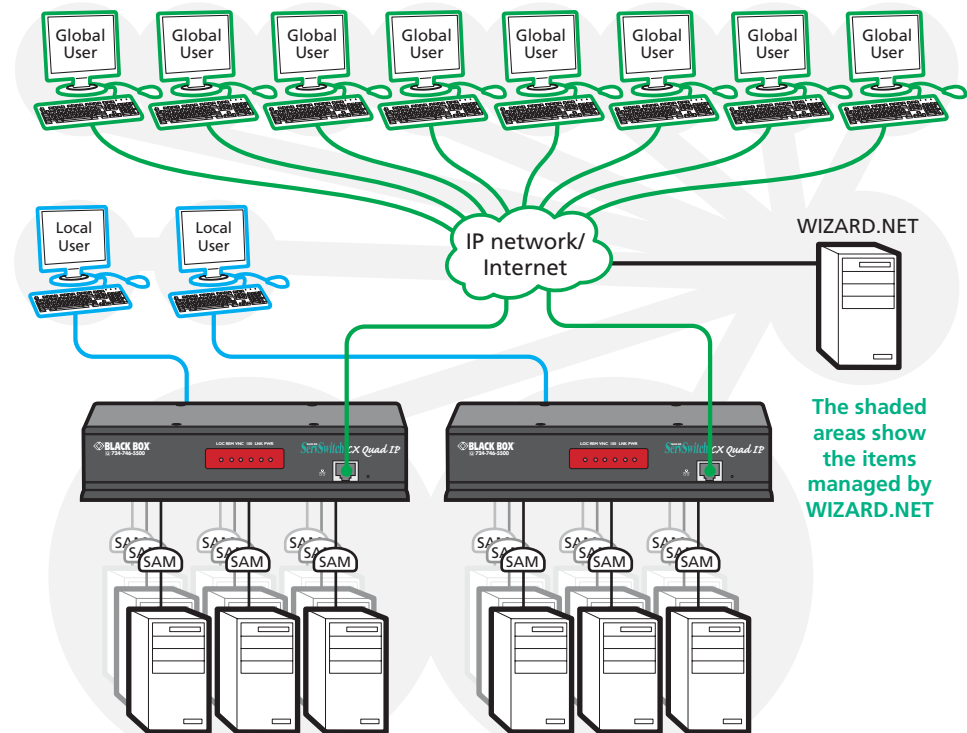

The KVM switch is required only to allow a single local user to access all hosts. Global users merely access the alternative IP addresses for the ServSwitch CX Quad IP units - this is one of the jobs handled by WIZARD.NET in order to simplify operation.



INSTALLATION

CONFIGURATION

OPERATION

FURTHER INFORMATION

INDEX

ServSwitch CX Quad IP features - front and rear

The ServSwitch CX Quad IP units pack a great deal of functionality into a compact space. It occupies half of a single 1U rack space and presents most of its connectors at the rear face. The smart front face features the network port and the operation indicators.

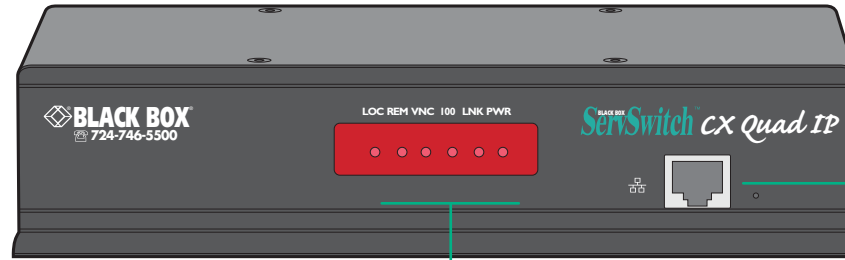

IP network port

The port by which global users are linked to the ServSwitch CX Quad IP unit. This intelligent Ethernet port can automatically sense whether it is attached to a 10Mb or 100Mb network.

Indicators

These six indicators clearly show the key aspects of operation:

- **LOC** Keyboard or mouse data are being received from the local console.
- **REM** Keyboard or mouse data are being received from the remote console.
- **VNC** Indicates that a global user is connected and active.
- **100** Indicates the Ethernet network speed (10/100Mbps).
- **LNK** Indicates that a network link is present.
- **PWR** Indicates that power is present.

Options port

This RS232 serial port can separately support the following functions:

- Power switching - can be configured to control multiple power switching devices.
- Remote control switching - commands can be received that will change the channel, as necessary.
- Synchronization - allows the actions of two or more ServSwitch CX Quad IP switches to be synchronized so that multiple computers/video screens can be switched and accessed.

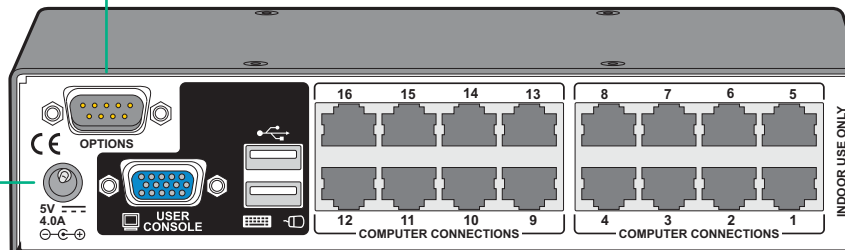

Power input
The power supply connects here.

Local user port

Connect a USB keyboard and mouse, plus a video monitor to these connectors. These allow you to perform the initial configuration of the ServSwitch CX Quad IP. Additionally, you can use these to locally control the connected computer(s).

Computer ports

Each computer connects to one of these ports via standard category 5, 5e or 6 cabling. At the other end of the cabling a SAM (Server Access Module) is used to provide the necessary keyboard, video and mouse connections.

INSTALLATION

CONFIGURATION

OPERATION

FURTHER INFORMATION

INDEX

What's in the box

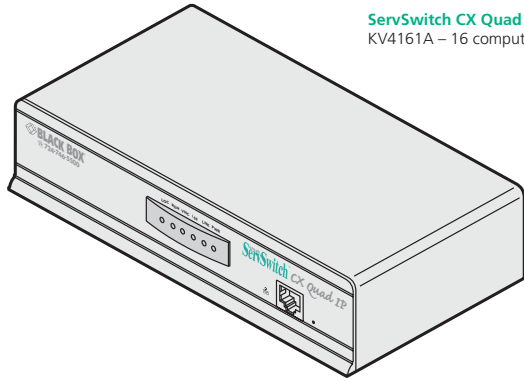

ServSwitch CX Quad IP
KV4161A – 16 computer connections, 1 local console connection, 4 global user (network) connections

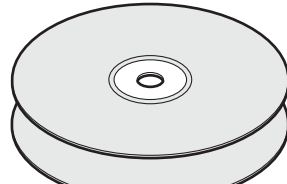

CD-ROM x 2

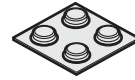

Four self-adhesive rubber feet

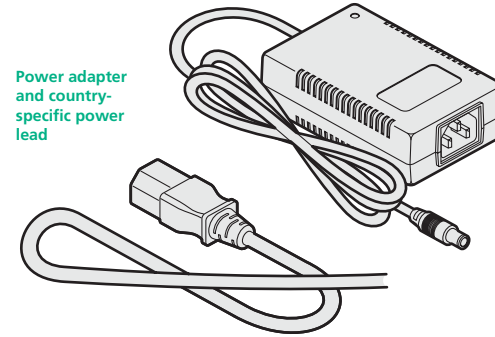

Power adapter and country-specific power lead

What you may additionally need

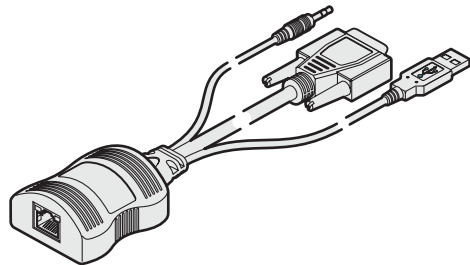

Server Access Modules

One required per connected computer. There are three different formats, depending on the required computer connections:

PS/2-style

Connectors: Analog video, PS/2-style keyboard and PS/2-style mouse.

USB

Connectors: Analog video and USB keyboard/mouse.

Sun with audio

Connectors: Analog video, Sun keyboard/mouse and 3.5mm audio jack.

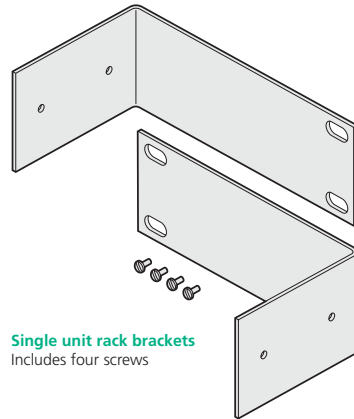

Single unit rack brackets
Includes four screws

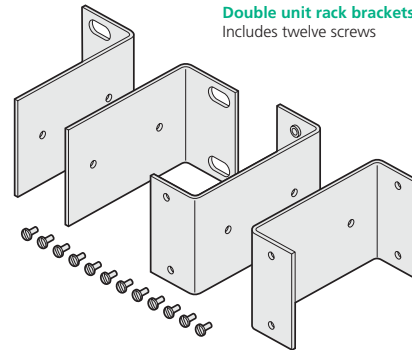

Double unit rack brackets
Includes twelve screws

INSTALLATION

CONFIGURATION

OPERATION

FURTHER INFORMATION

INDEX

Installation



Mounting

The ServSwitch CX Quad IP units offer three main mounting methods:

- Supplied four self-adhesive rubber feet
- Optional single unit rack brackets
- Optional double unit rack brackets

Connections

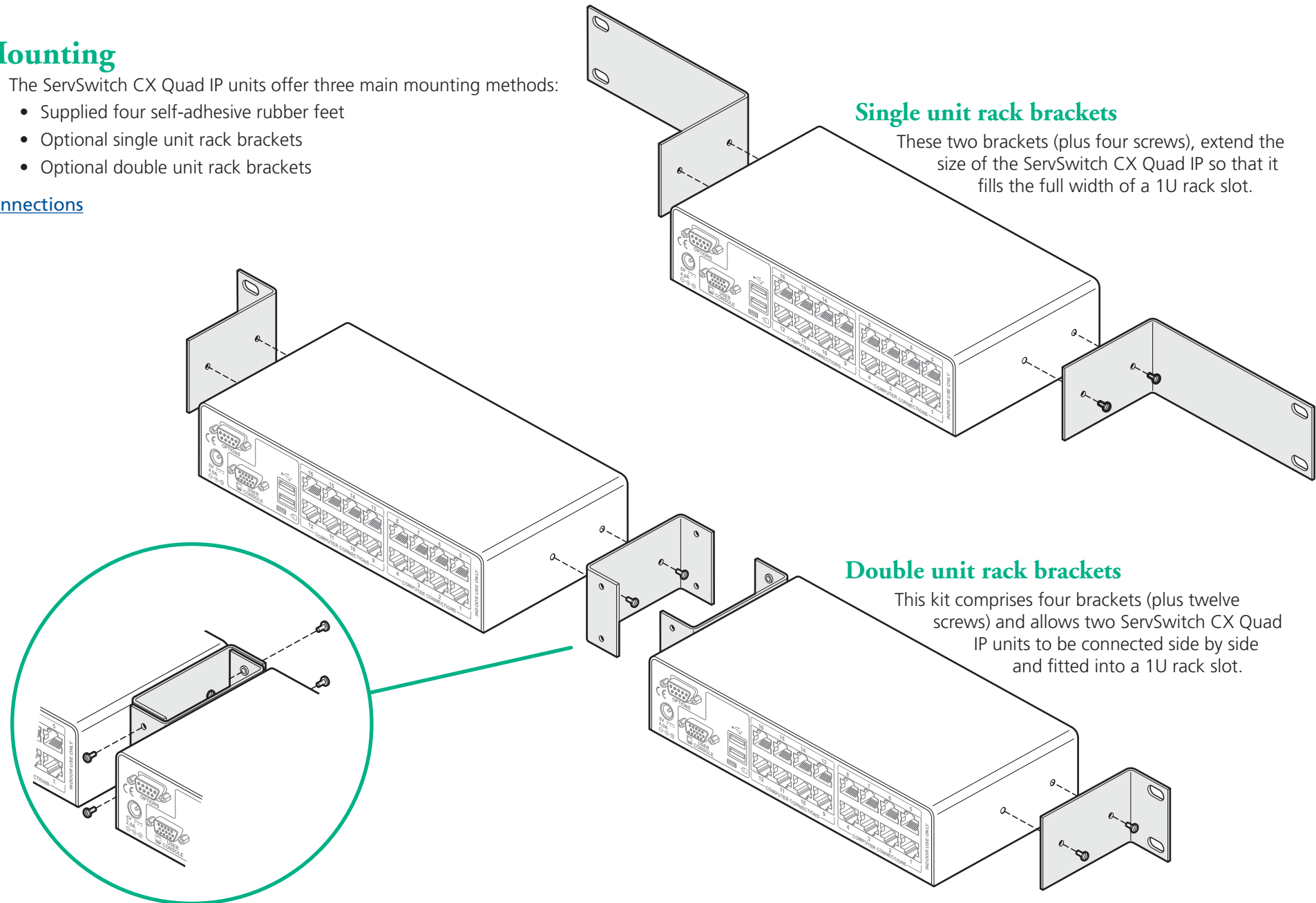

INSTALLATION

CONFIGURATION

OPERATION

FURTHER INFORMATION

INDEX

Connections

The ServSwitch CX Quad IP provides a great deal of flexibility in its configurations. This chapter details the various connections that can be made to achieve the required installation.

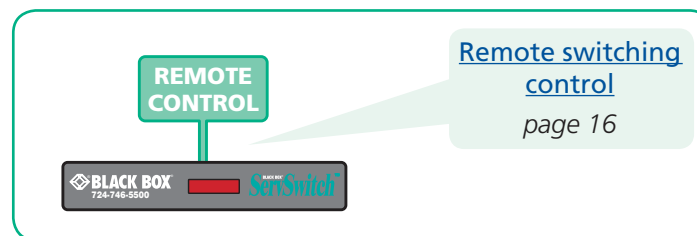
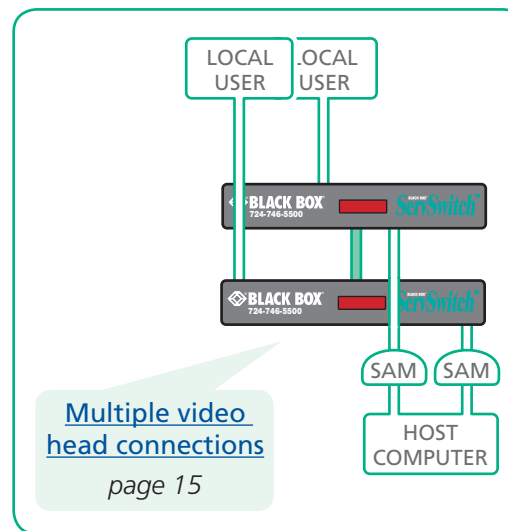
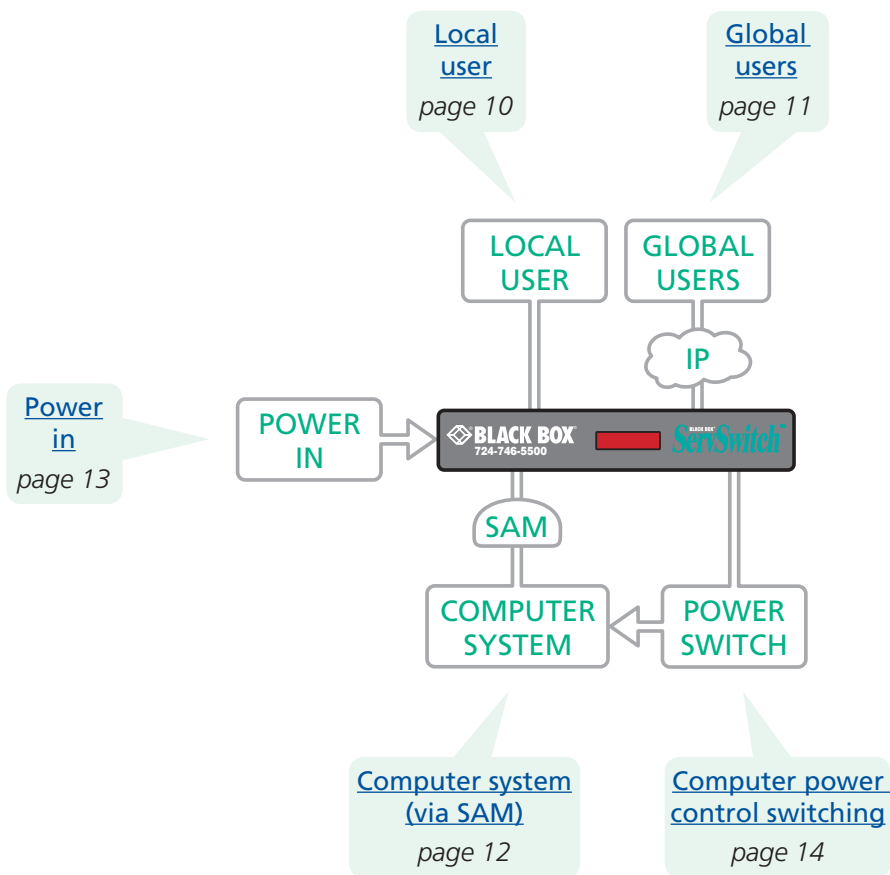

Connections do not need to be carried out in the order given within this guide, however, where possible connect the *power in* as a final step.



- INSTALLATION
- CONFIGURATION
- OPERATION
- FURTHER INFORMATION
- INDEX

Local user

A locally connected video monitor, keyboard (and mouse) are required during the initial configuration. These are also useful during normal use to allow quick local control of any connected computer systems. The ServSwitch CX Quad IP unit directly supports USB style keyboards and mice.

Note: Rather than connecting a separate keyboard and mouse, you can alternatively attach a combined keyboard and mouse device (such as a KVM rack drawer) to just one of the USB ports. However, the switch will only support one logical keyboard device and one logical mouse device.

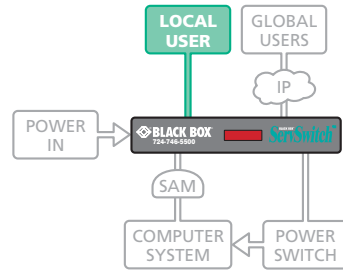

To connect the local user port

- 1 Position a suitable video monitor, keyboard and mouse in the vicinity of the ServSwitch CX Quad IP unit such that their cables will easily reach.
- 2 Attach the video monitor, keyboard and mouse connectors to the sockets, collectively labelled as USER CONSOLE, at the rear of the ServSwitch CX Quad IP unit.

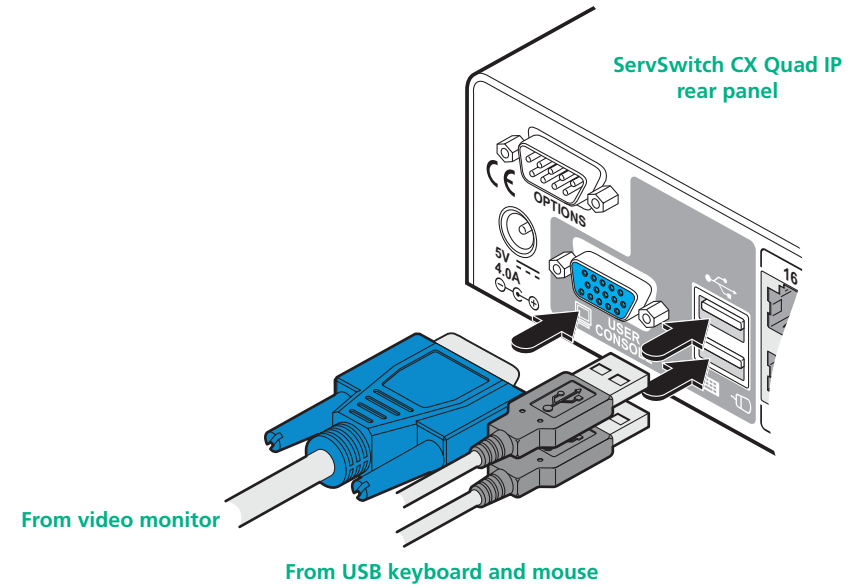

Global users (IP network port)

The ServSwitch CX Quad IP provides an autosensing Ethernet IP port that can operate at 10 or 100Mbps, according to the network speed. The ServSwitch CX Quad IP is designed to reside quite easily at any part of your network:

- It can be placed within the local network, behind any firewall/router connections to the Internet, or
- It can be placed externally to the local network, on a separate sub-network or with an open Internet connection.

Wherever in the network the ServSwitch CX Quad IP is situated, you will need to determine certain configuration issues such as address allocation and/or firewall adjustment to allow correct operation. Please refer to [Networking issues](#) within the Configuration chapter for more details.

IMPORTANT: When an ServSwitch CX Quad IP is accessible from the public Internet or dial up connection, you must ensure that sufficient [security measures](#) are employed.

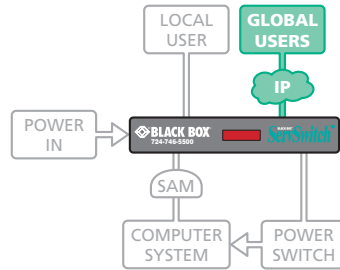

To connect the IP network port for global users

- 1 Depending upon where in the network the ServSwitch CX Quad IP is being connected, run a category 5, 5e or 6 link cable from the appropriate hub or router to the ServSwitch CX Quad IP unit.
- 2 Connect the plug of the link cable into the IP port on the front panel of the ServSwitch CX Quad IP unit.

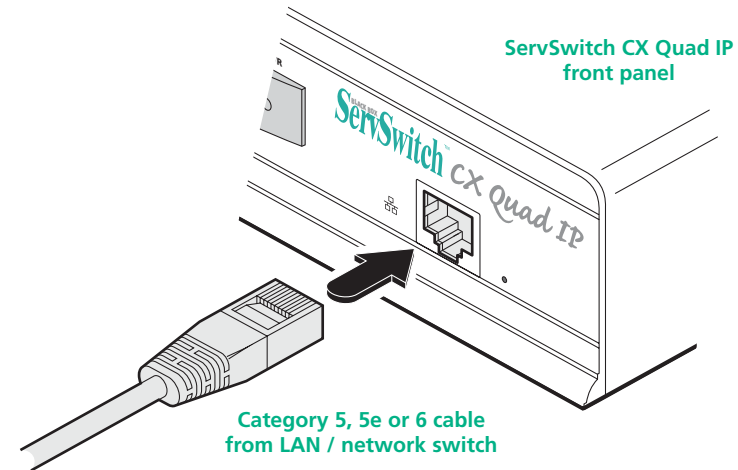

- 3 Configure the network settings as appropriate to the position of the ServSwitch CX Quad IP within the network - see [Networking issues](#) for details.



Computer system (via SAM)

Each computer system is connected to the ServSwitch CX Quad IP unit via a Server Access Module (SAM) and standard category 5, 5e or 6 cabling. SAMs are available in various formats to suit differing computer system types and their particular connector styles.

Each SAM uses Keep Alive technology to ensure that the keyboard and mouse inputs to the computer remain active, even when the particular channel is not selected. This action ensures that there are no connection delays or problems as the port is selected.

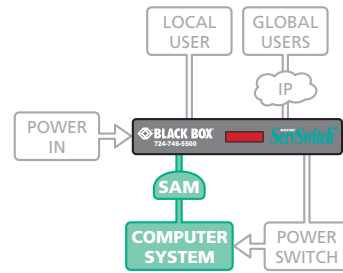

To connect a computer system

- 1 Ensure that power is disconnected from the ServSwitch CX Quad IP unit and the system to be connected.
- 2 Locate the required SAM (there are three types available) and attach its video, keyboard and mouse (PS/2-style, USB or Sun) to the relevant sockets on the computer system.

A range of different connector combinations are made available across the five SAM formats

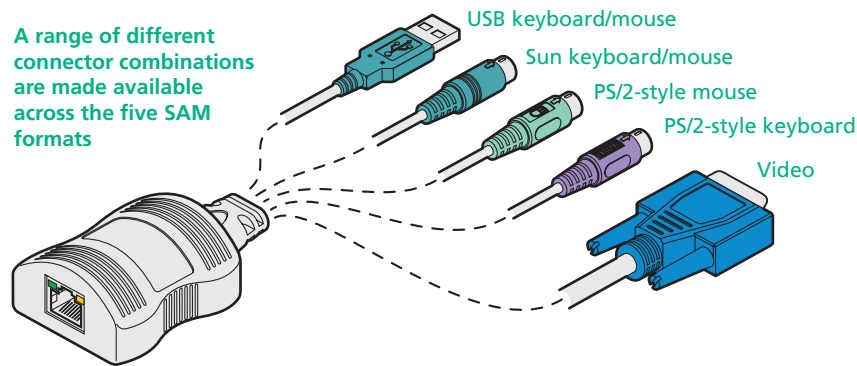

- 3 Lay a suitable length of category 5, 5e or 6 cabling between the computer system and the ServSwitch CX Quad IP unit. The maximum length of the cable is 10 m (32 feet).

- 4 Attach the connector of the cable run to the socket of the SAM.

Green indicator - power present
Yellow indicator - signal activity

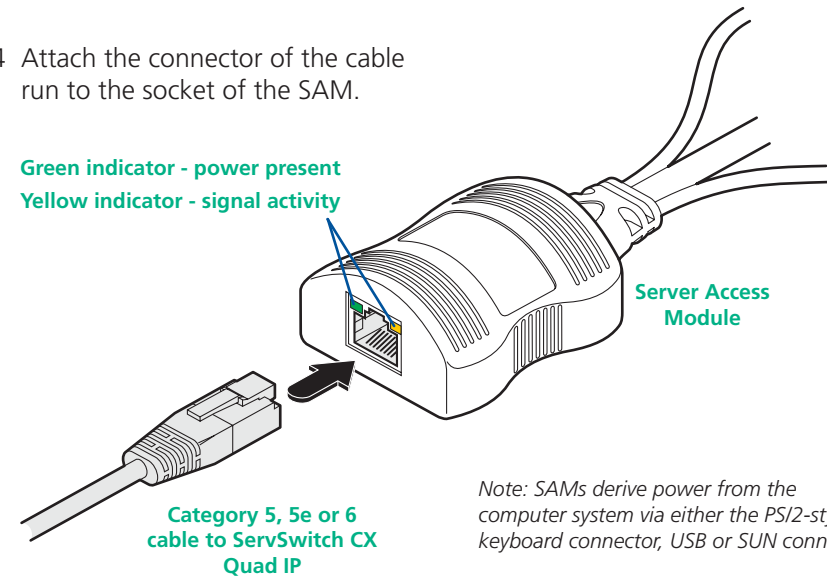

- 5 At the other end of the cable run, attach the cable connector to one of the sockets labelled COMPUTER CONNECTIONS on the rear panel of the ServSwitch CX Quad IP unit.

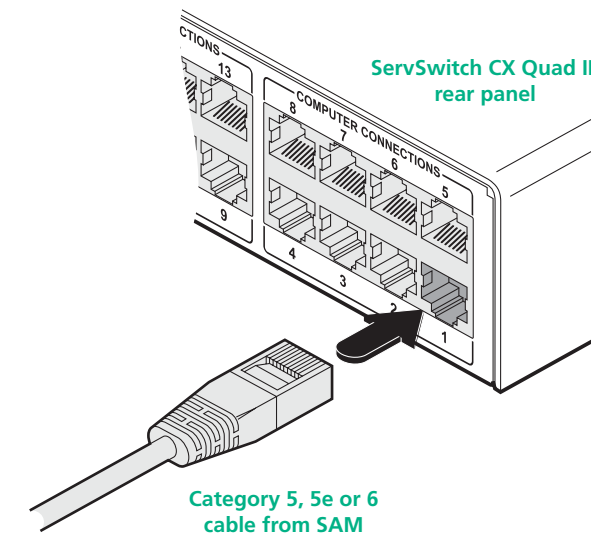

INSTALLATION

CONFIGURATION

OPERATION

FURTHER INFORMATION

INDEX

Power in connection

The ServSwitch CX Quad IP unit is powered by the supplied 5V power adapter. There is no on/off switch on the unit, so operation begins as soon as a power adapter is connected.

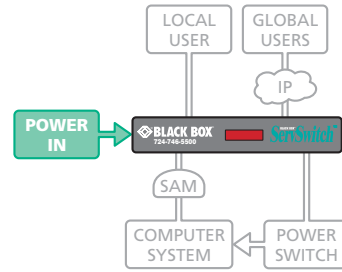

To connect the power supply

- 1 Attach the output lead from the power adapter to the 5V socket on the rear panel of the ServSwitch CX Quad IP.

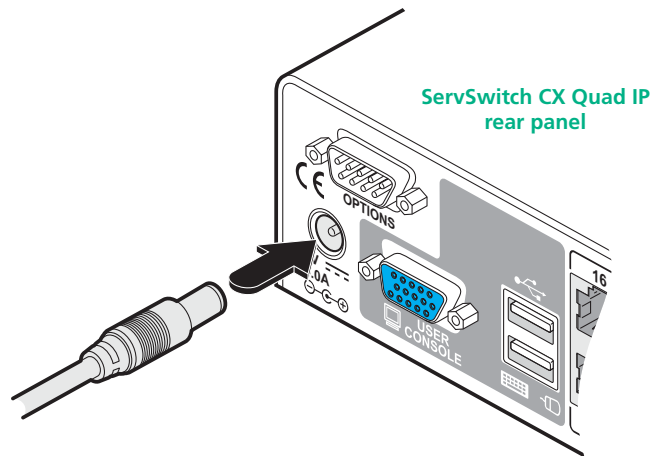

Output lead from power adapter

- 2 Connect the IEC connector of the supplied country-specific power lead to the socket of the power adapter.

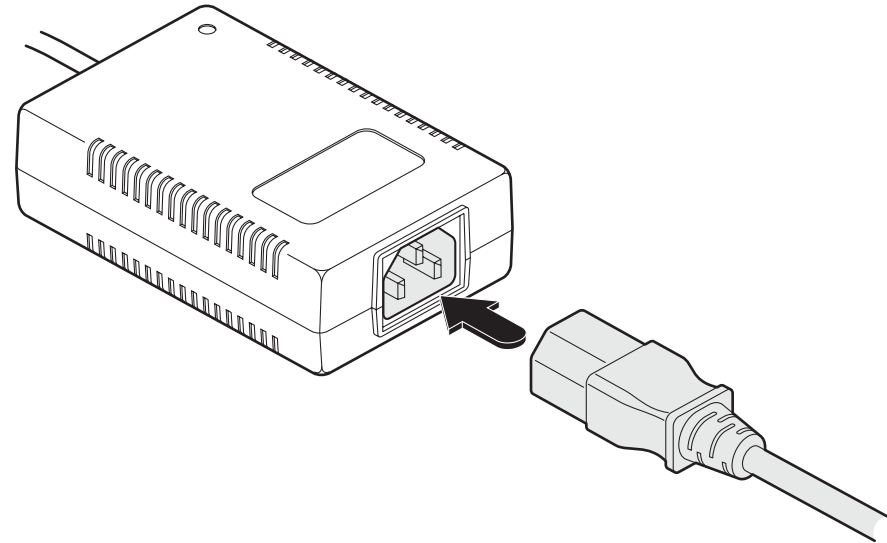

- 3 Connect the power lead to a nearby main supply socket.

Note: Both the ServSwitch CX Quad IP and its power supply generate heat when in operation and will become warm to the touch. Do not enclose them or place them in locations where air cannot circulate to cool the equipment. Do not operate the equipment in ambient temperatures exceeding 40 degrees Centigrade. Do not place the products in contact with equipment whose surface temperature exceeds 40 degrees Centigrade.



Power control port

The options port of the ServSwitch CX Quad IP can be used to connect to one or more optional power control units. This allows you to control the mains power being supplied to the connected computer(s) so that an authorized user can, if necessary, perform a complete remote cold reboot on a failed system.

The control connector of the first power switch is attached, via serial cable, to the rear panel of the ServSwitch CX Quad IP. Any additional power switches are then attached via a 'daisy-chain' arrangement to the first power switch. Each power switch box is then given a unique address and access to each power port (8 ports on each power switch box) is gained using a combination of the switch box address and the port number.

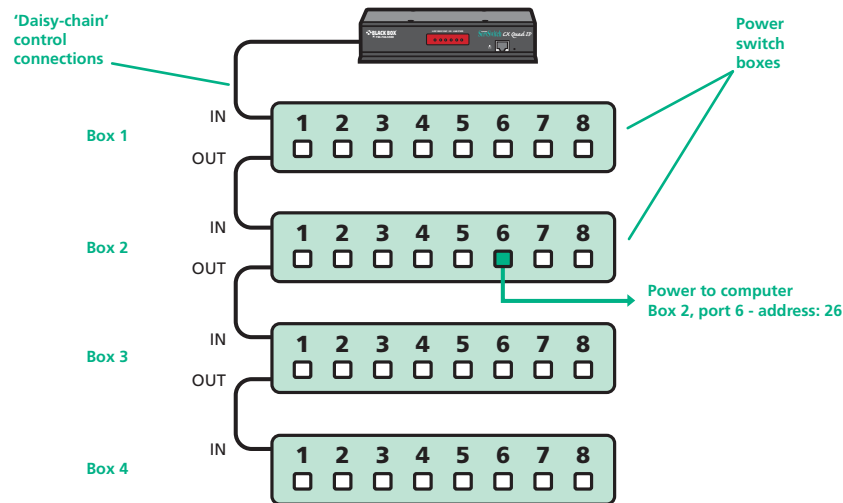
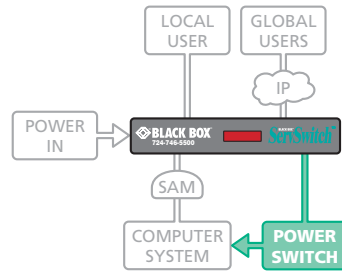

The power ports are connected to the power inputs of each computer system and the power switch box(es) are then connected to a mains power supply.

IMPORTANT: Power switching devices have a maximum current rating. It is essential to ensure that the total current drawn by the equipment connected to the power switching device does not exceed the current rating of the power switching device. You must also ensure that the current drawn from any mains socket does not exceed the current rating of the mains socket.

Setting up, configuring and using power switching requires three main steps:

- Connect and address the switch boxes ⇔
- [Configure the power strings](#)
- Operate power switching [via the VNC toolbar](#) or the local [Functions menu](#).

To connect and address the switch boxes

Note: The ServSwitch CX Quad IP unit can be powered on during this procedure, however, the switch boxes should be switched off. The configuration steps below are for one particular type of power switch. Other power switches may require different configuration. Please refer to your power switch documentation.

- 1 Mount up to four switch boxes in positions where they are close to the computer systems that they will control and not too distant from the ServSwitch CX Quad IP unit (preferably within 2.5 metres).
- 2 Use a serial cable with an RJ9 and a 9-pin D-type connector (see [Appendix 8](#) for specification). Attach the RJ9 plug to the socket marked IN on the first switch box. Attach the other end to the socket marked OPTIONS on the ServSwitch CX Quad IP.

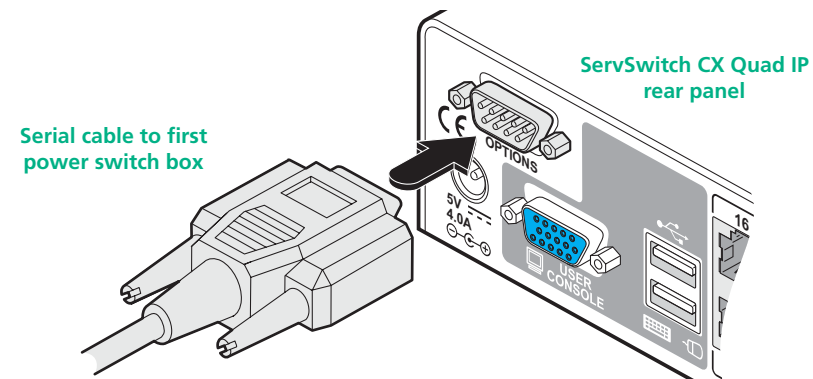

- 3 For each of the remaining switch boxes (if used), use a serial cable with RJ9 connectors at both ends (see [Appendix 8](#) for specification). Attach one end to the socket marked OUT of the previous box and the other end to the socket marked IN of the next box.

- 4 Set the addressing switches on each switch box using the two micro switches marked 'Slct' on the front panel. The box connected directly to the ServSwitch CX Quad IP is Box 1 and so on, down the daisy-chain line to Box 4 at the end.

Box	Switch 1	Switch 2
1	Off	Off
2	On	Off
3	Off	On
4	On	On

Off = switch upwards
On = switch downwards
Switch 1 is on the left side

- 5 Attach IEC to IEC power leads between each port and the power input socket of each computer system that requires power switching. Carefully note to which power ports, on which boxes, each computer system is connected. If computer systems have multiple power inputs, then each input must be connected via separate ports, which can be on the same, or different boxes.

- 6 Connect each box to a suitable mains power input.

Now proceed to the configuration stage covered in the [Power switching configuration](#) section within the Configuration chapter.



Multiple video head connections

Two or more ServSwitch CX Quad IP units can be connected together so that they operate in a synchronized manner. Synchronized operation is useful for applications that require multiple video signals to be switched together. This type of operation is usually required where each computer is fitted with multiple video cards or video cards with multiple video heads. Whenever an ServSwitch CX Quad IP channel is switched, it sends an RS232 command out on its serial interface (marked OPTIONS on the rear panel). An ServSwitch CX Quad IP will switch its channel if it receives the same command on its serial interface. Consequently, by linking the serial interfaces, a master unit may be made to automatically switch one or more slave units as shown in the diagram.

Note: You must ensure that all ServSwitch CX Quad IP units have their Options serial ports set to 'Sync Units' and that their baud rates are identical. These settings can be made either via the [local](#) or [global](#) user configuration menus.

It should be noted that the synchronization cable deliberately does not have the transmit pin of the Slave End connector linked to the receive pin of the Master End connector. To do so would cause the Slave unit to be able to switch the Master unit. This would setup an endless cyclical switching sequence that would prevent the ServSwitch CX Quad IP devices from operating correctly. For more details about the serial synchronization cables, see [Appendix 8](#).

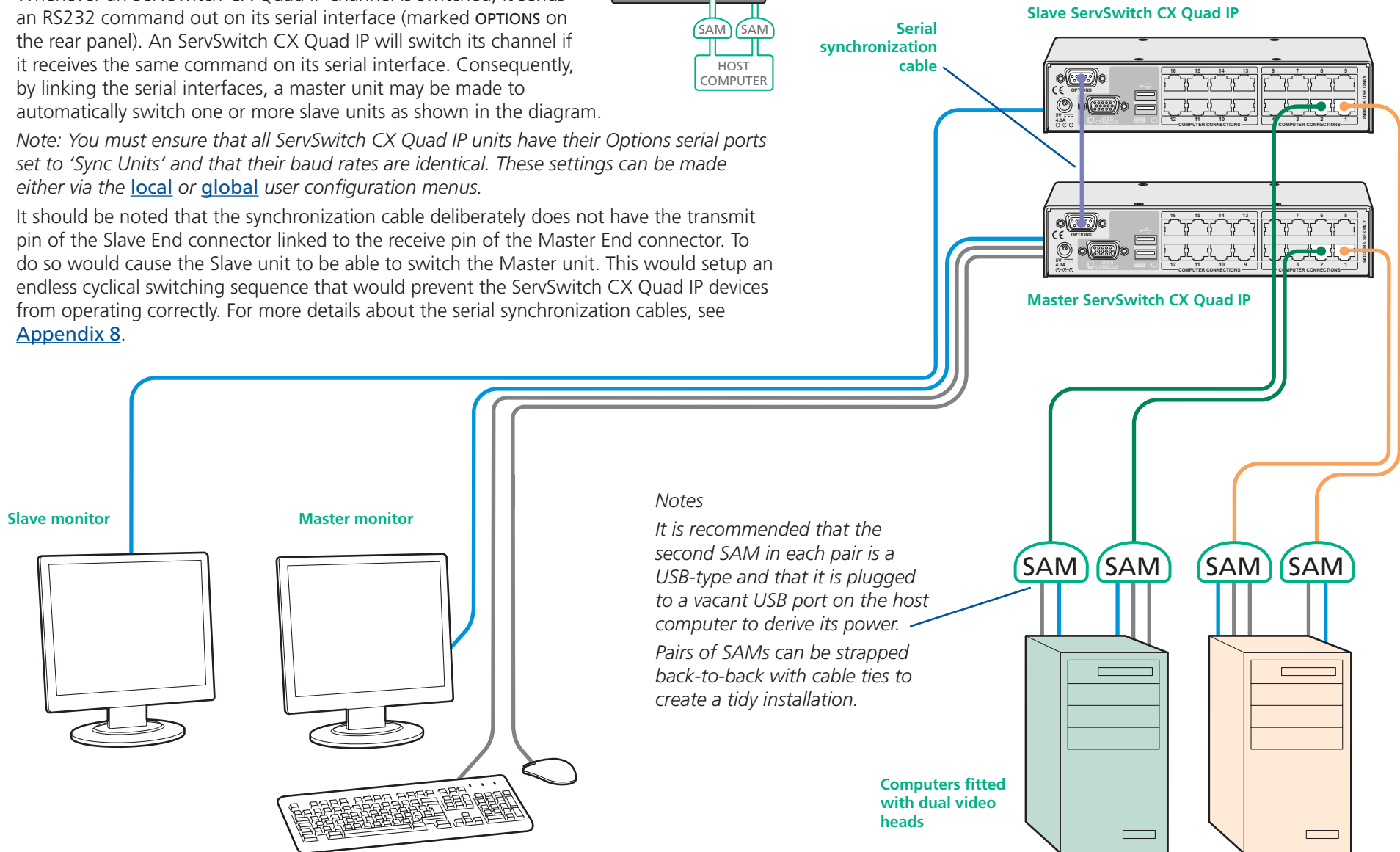
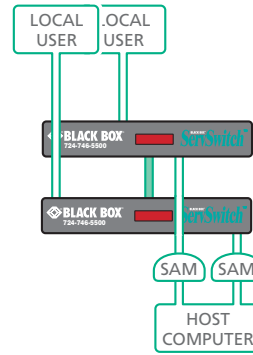

Notes

It is recommended that the second SAM in each pair is a USB-type and that it is plugged to a vacant USB port on the host computer to derive its power. Pairs of SAMs can be strapped back-to-back with cable ties to create a tidy installation.

Computers fitted with dual video heads



Remote switching control

The port switching functions of the ServSwitch CX Quad IP unit can be remotely controlled by an RS232 link to the OPTIONS port on the rear panel.

The sending device must use the following RS232 communication settings:

Baud rate: 19200 bps
 Data bits: 8
 Parity: None
 Stop bits: 1

No handshaking is implemented, however, valid command characters will be echoed back to the sending device.

Note: You must ensure that the ServSwitch CX Quad IP unit has its Options serial ports set to 'Sync Units'. This setting (together with the baud rate selection) can be made either via the [local](#) or [global](#) user configuration menus.

The value of the byte received via the serial link determines which computer port should be linked through to the user port. The table given here summarizes the valid control codes:

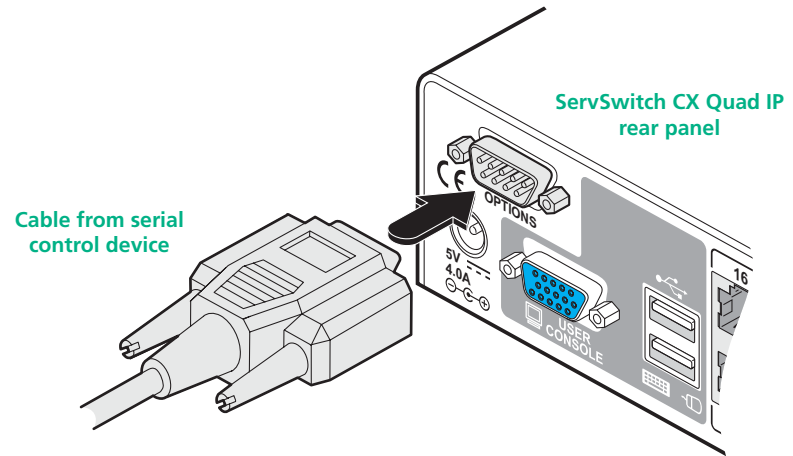

Host computer port/channel

	1	2	3	4	5	6	7	8	9	10	11	12	13	14	15	16	0 (video off)
Local user	10	11	12	13	14	15	16	17	18	19	1A	1B	1C	1D	1E	1F	71
VNC user 1	20	21	22	23	24	25	26	27	28	29	2A	2B	2C	2D	2E	2F	72
VNC user 2	30	31	32	33	34	35	36	37	38	39	3A	3B	3C	3D	3E	3F	73
VNC user 3	40	41	42	43	44	45	46	47	48	49	4A	4B	4C	4D	4E	4F	74
VNC user 4	50	51	52	53	54	55	56	57	58	59	5A	5B	5C	5D	5E	5F	75



- INSTALLATION
- CONFIGURATION
- OPERATION
- FURTHER INFORMATION
- INDEX

Configuration

Almost all configuration and operational aspects of the ServSwitch CX Quad IP unit are controlled via [on-screen menu](#) displays.

Overall initial configuration

When setting up a new installation, the following stages are recommended:

1 [Enable the general 'Security' option.](#)

With security disabled (default setting), a local or remote user attached to the ServSwitch CX Quad IP will have full and unrestricted access to all computers and all ServSwitch CX Quad IP settings. In larger installations, you are strongly recommended to enable security and set up individual user accounts with access privileges.

2 [Create an ADMIN \(administration\) password.](#)

All ServSwitch CX Quad IP units have a fixed user account that cannot be deleted or renamed, called ADMIN. If you intend to use security, then it is important to allocate a password to the ADMIN account.

3 [Create user accounts and allocate access rights.](#)

Use the ADMIN account to add user profiles, passwords and access rights for each of the system users.

4 [Provide names for computers.](#)

When numerous computers are attached, you are strongly advised to provide names for each, to assist with recognition.

5 Configure the required ['Setup Options'](#) and ['Global Preferences'](#)

Use the ADMIN account to determine key ServSwitch CX Quad IP settings and timing characteristics.



INSTALLATION

CONFIGURATION

OPERATION

FURTHER
INFORMATION

INDEX

Initial configuration

The ServSwitch CX Quad IP unit provides an initial configuration sequence to assist you to make the necessary settings.

When the ServSwitch CX Quad IP is switched on for the first time, you should see the unit configuration screen, as shown here ⇨

IMPORTANT: Complete the initial IP configuration and invoke security measures BEFORE the unit is connected to an open IP network.

If the ServSwitch CX Quad IP unit has been previously configured, it will display either the Login dialog or the Select Host screen, as shown here ⇨

CX Quad IP Login

Username:

Password:

If the Login is shown, enter your 'admin' Username and Password - or press **[F2]** twice if none have yet been defined.

CX Quad IP Select Host

Computer	Port	Status
Computer 01	01	●
Computer 02	02	●
Computer 03	03	●
Computer 04	04	●
Computer 05	05	●
Computer 06	06	●
Computer 07	07	●
Computer 08	08	●

User: Status:

F1 - more menus F3 - Find
ESC - Quit F4 - Logout

From the Select Host screen, press **[F2]** to display the Main Menu. See [Main Menu](#) for more details.

CX Quad IP Main Menu

- Functions
- User Preferences
- Global Preferences
- Setup Options
- Configuration

Back

Within the Main Menu, use the **[↓]** and **[↑]** keys to highlight an option, then press **[Enter]** to select.

The Configuration option provides access to separate Unit, Network and Serial Configuration screens that are similar in function to the first three setup screens shown on the right.

1 CX Quad IP Unit Config

Hardware: CXQUADIP 32M+32M
Firmware: 1.06.13
Keybd Layout: UR
Admin Passwd: XXXXXXXXXX
Unit Name:
Time: 00:59:52
Date: 01 Jan 2000
Encryption: Prefer Off

Screen 1 of 5 Next

Admin password

Enter a password of at least six characters that has a mix of letters and numerals. The background colour provides an indication of password suitability and is initially red to indicate that the password is not sufficient. When a password with reasonable strength has been entered it will change to green.

Time and Date

Set these correctly as all entries in the activity log are time stamped using them.

Encryption

See [Encryption settings](#) for a description of the issues and the settings.

2 CX Quad IP Network Config

MAC Address: 66:CB:23:00:00:22
Use DHCP: No
IP Address: 192.168.1.22
Net Mask: 255.255.255.0
Gateway:
UNC Port: 5900
HTTP Port: 80

Screen 2 of 5 Next

UseDHCP/IP address/Net Mask/Gateway

You need to either set the DHCP option to 'Yes' or manually enter a valid IP address, Net mask and Gateway. See [Networking issues](#) for more details.

VNC and HTTP ports

These should remain set to 5900 and 80, respectively, unless they clash with an existing setup within the network. See [Networking issues](#) for more details.

3 CX Quad IP Serial Config

Options Port: Power Control
Options Baud: 9600

Screen 3 of 5 Next

Option port (serial) details

These two items control the use of the OPTIONS port on the rear panel of the unit. The port can either be used to control optional power switching devices or can be used to synchronize the operation of two separate ServSwitch CX Quad IP units.

If neither of these features are required, then you do not need to change anything on this screen.

4 CX Quad IP Secure Keys

Random data is required to generate encryption keys for secure UNC access. Please move the mouse or press keys until the bar becomes full.

Screen 4 of 5

Secure keys generation

With every mouse move and keypress, the single dash will move across the screen (unless the same key is pressed repeatedly). Periodically, a new star character will be added to the bar as the random data are accepted as part of the new encryption key. When the bar is full, the final encryption keys for your ServSwitch CX Quad IP will be created – this process takes roughly 30 to 40 seconds. Once the secure keys have been calculated the ServSwitch CX Quad IP will show either the Login dialog or Select Host screen.

Note: Screen 5 of 5 is displayed while the secure keys are being generated.



- INSTALLATION
- CONFIGURATION
- OPERATION
- FURTHER INFORMATION
- INDEX

Main menu

The main menu allows you to determine many aspects of the ServSwitch CX Quad IP capabilities. From here you can:

- Provide names for all connected computers to allow quick recognition,
- Set individual and global settings for users,
- Run various functions, such as mouse restore operation,
- Configure unit, network and serial port settings.

To access the main menu

- 1 If the select host menu is not already displayed, press and hold **Ctrl** and **Alt** and then press **M** using a keyboard attached to a ServSwitch CX Quad IP user port.

The select host menu will be displayed:

Computer	Port	Availability of each computer:
Computer 01	01	Green - accessible
Computer 02	02	Red - inaccessible
Computer 03	03	Orange - an inconsistency related to a cascade linked host has been detected - More !+
Computer 04	04	Green - accessible
Computer 05	05	Red - inaccessible
Computer 06	06	Green - accessible
Computer 07	07	Red - inaccessible
Computer 08	08	Red - inaccessible

Default names for each computer port

Your Login name: admin

Status: Shared

Search for a particular computer name

Port numbers

Connection status

Availability of each computer:
 Green - accessible
 Red - inaccessible
 Orange - an inconsistency related to a cascade linked host has been detected - More !+

F1 - more menus F3 - Find
 ESC - Quit F4 - Logout

- 2 Press **F1** to display the main menu:

CX Quad IP Main Menu

- Functions
- User Preferences
- Global Preferences
- Setup Options
- Configuration
- Back

- 3 Use the **↓** and **↑** keys to highlight an option, then press **↵** to select.

Hotkeys

Note: **Ctrl** and **Alt** are the standard hotkeys and can be **altered** to avoid clashes with other devices or software. If you change the hotkeys, remember to use the new ones in place of **Ctrl** and **Alt** when following the instructions in this guide.

Security

Note: If the security option has been enabled, you will be asked for a valid user name and password before the main menu can be displayed.

CX Quad IP Login

Username:

Password:

IMPORTANT: When supplied, ServSwitch CX Quad IP units have their security features disabled, which means that any attached users have access to all connected computers and all ServSwitch CX Quad IP settings. You are strongly recommended to **enable the 'Security' feature** and set an access password for the ADMIN account.

Menu layout

The various menu options are arranged as shown here →
 For a description of each option within the Configuration menus, see [Appendix 1](#) for more details.

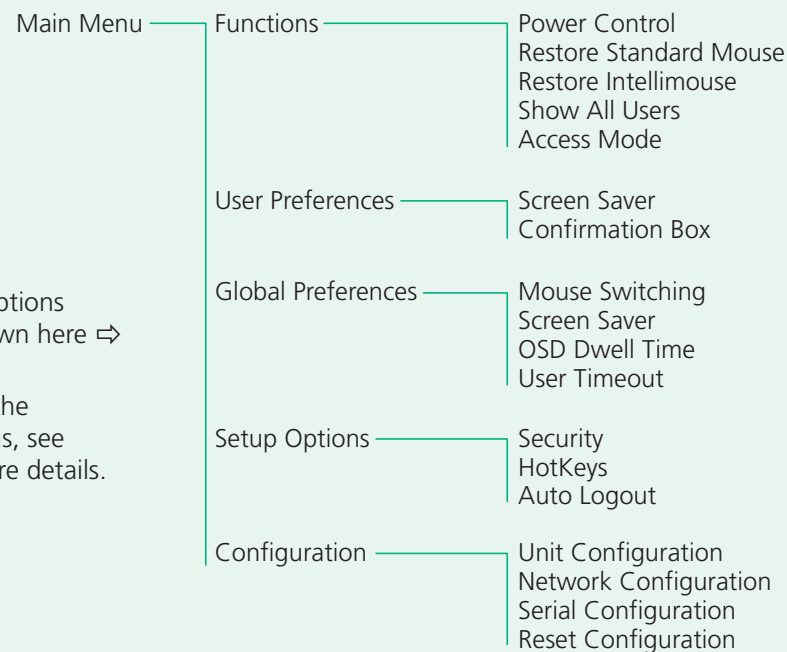



General security and configuration steps

To enable general security

- 1 Display the [Main menu](#).
- 2 Highlight 'Setup Options' and press .
- 3 Highlight 'Security' and press  (or click one of the arrow buttons) to select 'Enabled'.
- 4 Now create a new password for the ADMIN user account - see below.

To set an ADMIN password



- 1 Display the [Main menu](#).
- 2 Highlight 'Configuration' and press .
- 3 Highlight 'Unit Configuration' and press .
- 4 Using the cursor keys, move the cursor to the 'Admin Passwd' field.
- 5 Enter an appropriate password for the ADMIN user account with regard to the following:
 - The password can be up to 16 characters long.
 - The password can use letters, numerals and/or punctuation marks in any combination.
 - The password is case sensitive.

Note: The field background colour will remain red until sufficient characters have been entered to form a reasonably robust password.

- 6 Once the password has been entered, you can navigate away from the menu page and it will be automatically saved.

[What to do if the ADMIN password has been forgotten.](#)

To change the hotkeys

The ServSwitch CX Quad IP unit uses  and  as its standard hotkeys. These can be changed if they clash with other software or hardware within the installation.

- 1 Display the [Main menu](#).
- 2 Highlight 'Setup Options' and press .
- 3 Highlight 'Hotkeys' and press  (or click one of the arrow buttons) to select the required hotkey combination. The options are: *Ctrl+Alt*, *Ctrl+Shift*, *Alt+Shift*, *Alt Gr*, *Left+Right Alt*, *Left Ctrl+Alt* or *Right Ctrl+Alt*.

Registering users and host computers

All user and host computer registration is achieved solely via the global (network) connection to the ServSwitch CX Quad IP unit. See [Appendix 2 - Configuration pages via viewer](#) for details.



INSTALLATION

CONFIGURATION

OPERATION

FURTHER INFORMATION

INDEX

What to do if the ADMIN password has been forgotten

If the ADMIN password becomes mislaid or forgotten, you will not be able to access the ServSwitch CX Quad IP to add or edit users and computer names, unless you have given other users admin privileges. This situation may be resolved by performing a complete reset to return the ServSwitch CX Quad IP.

IMPORTANT: A complete reset erases all the user names and computer names that you have setup.

To clear a password (and restore factory default settings)

- 1 Remove power from the ServSwitch CX Quad IP unit.
- 2 Press and hold the reset button on the front panel (requires paper clip or similar).
- 3 Apply power and after a couple of seconds release the reset button. The Maintenance menu will be displayed ⇒

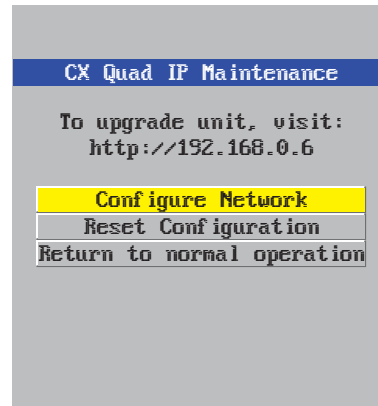

- 4 Highlight 'Reset Configuration' and press **↵**. The Reset Config warning will be displayed ⇒
- 5 Highlight 'Reset' and press **↵**. All settings will be returned to their factory defaults and the previous Maintenance menu will be re-displayed.
- 6 Remove power from the unit and then re-apply it.
- 7 You now need to go through the [initial configuration procedure](#) and re-instate all of the required settings.

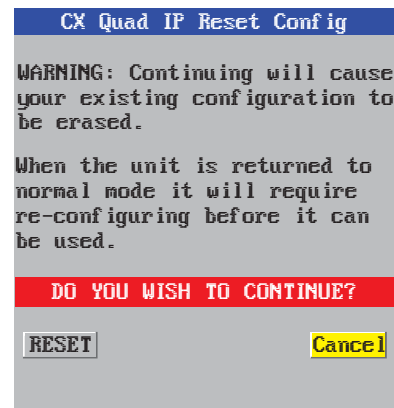

Clearing IP access control

This option removes all entries from the IP access control feature within the ServSwitch CX Quad IP.

What is IP access control?

The IP access control feature (configurable by a remote admin user) allows certain network address ranges to be denied access to the ServSwitch CX Quad IP. If set incorrectly, it is possible to exclude all network users and so this option provides an emergency recovery point.

To clear IP access control

- 1 From a local keyboard (not accessible from a global keyboard), log on as the 'admin' user.
- 2 Press **Ctrl** **Alt** **M** (hotkeys can change).
- 3 Press **F1** to select the More Menus.
- 4 Select 'Configuration'.
- 5 Select 'Network Configuration'.

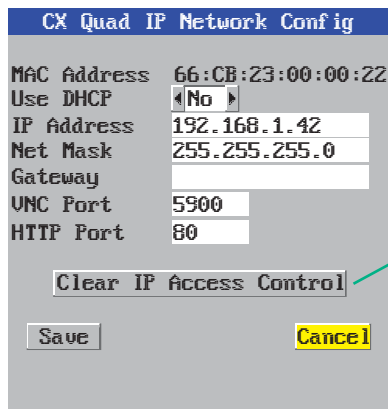

Click here to remove all IP access restrictions

- 6 Highlight the 'Clear IP Access Control' option and press **Enter**.





Full configuration by global user

Once the basic features have been configured using the ServSwitch CX Quad IP configuration menus, further changes can be made by authorized global users via the VNC interface. There are two main ways to use the VNC interface to access the ServSwitch CX Quad IP unit:

- [The VNC viewer](#) – a small application supplied on the CD-ROM or downloadable from the RealVNC website or even downloadable from the ServSwitch CX Quad IP itself.
- or
- [A standard browser that supports Java](#) – When a web browser makes contact, the ServSwitch CX Quad IP provides the option to download a Java application to it. This allows a viewer window to be opened and operation to commence just as it would with the VNC viewer application.

To configure the unit from a global user location

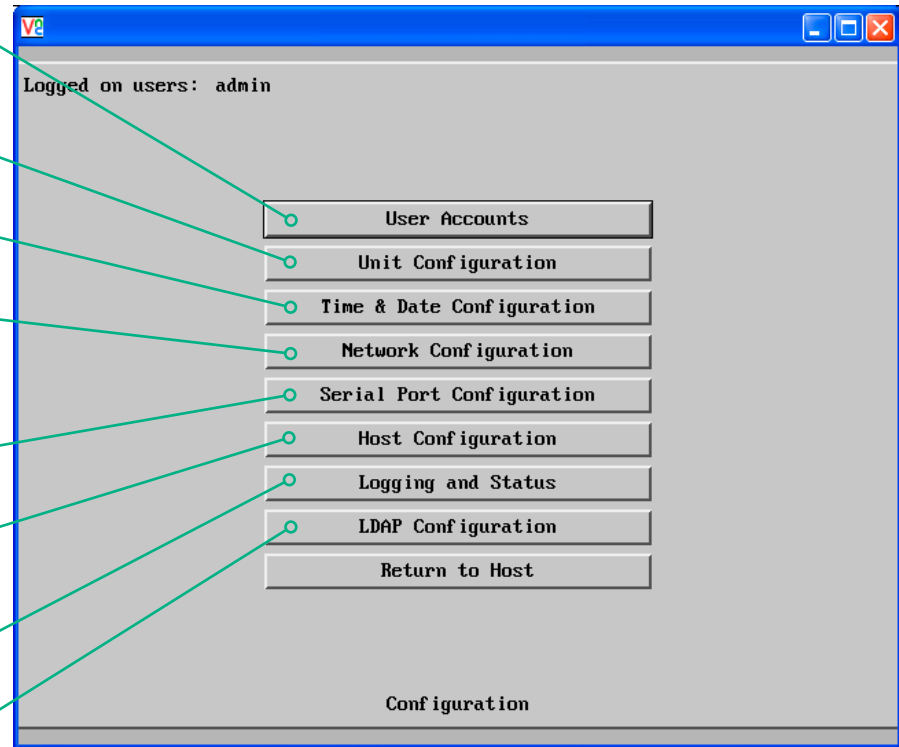
- 1 Use either the VNC viewer or a standard web browser to make remote contact with the ServSwitch CX Quad IP – see [Global user access](#) for more details.
- 2 If the username entry is not blanked out, enter 'admin'. Then enter the admin password or the username / password of a user with admin privilege (if no password is set, then just press ). Once logged in, the ServSwitch CX Quad IP will show the video output from the host system (if one is connected), or otherwise a 'No Signal' message.
- 3 Click the Configure button in the top right  hand corner of the window to display the main configuration page 

User Accounts

Allows you to create and manage up to sixteen separate user accounts, each with separate access permissions.

Unit Configuration

Allows you to alter both basic and fundamental settings within the unit.

Time & Date Configuration

Allows you to configure all aspects relating to time keeping within the unit.

Network Configuration

Here you can alter any of the existing network settings plus you can take advantage of the IP access control feature that lets you to specifically include or exclude certain addresses or networks.

Serial Port Configuration

Lets you setup or alter the details concerning the OPTIONS serial port.

Host Configuration

Allows you to configure user access, hot key switching and power control codes for the connected host systems.

Logging and Status

Provides various details about the user activity on the unit.

LDAP Configuration

Allows you to configure settings which enable the unit to consult external databases in order to verify user details.

Shaded items signify options that are not available via the standard configuration menus.

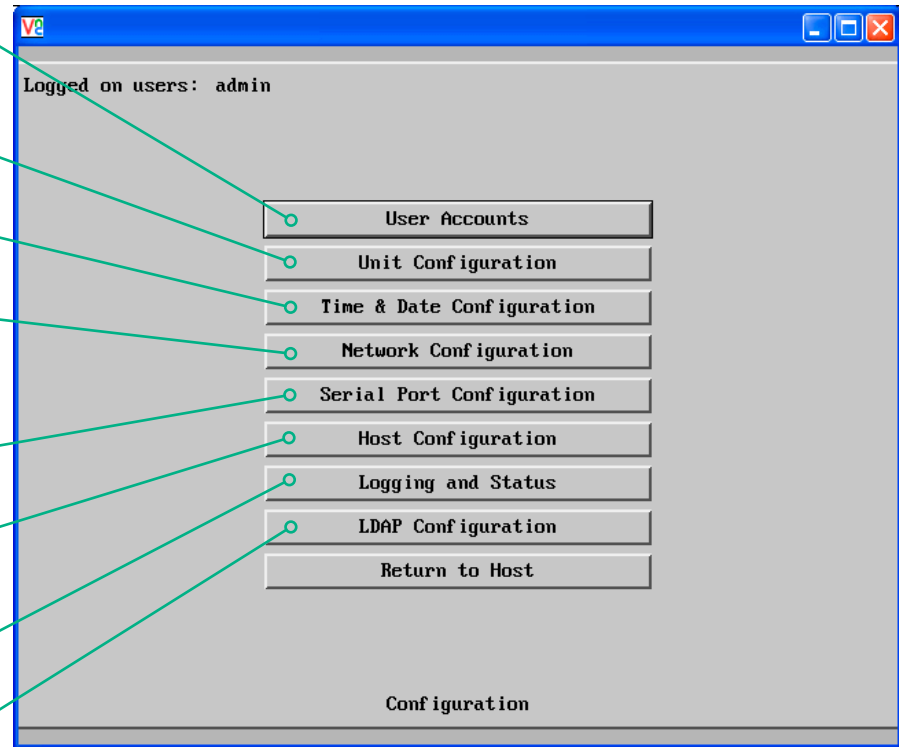

For more information about each page, please see [Appendix 2 - Configuration pages via viewer](#) in the 'Further information' chapter.



- INSTALLATION
- CONFIGURATION
- OPERATION
- FURTHER INFORMATION
- INDEX

Encryption settings

The ServSwitch CX Quad IP offers a great deal of flexibility in its configuration and this extends equally to its encryption settings that are used to prevent unauthorized interception of signals. Due to the variety of situations in which the ServSwitch CX Quad IP might be used and the range of viewer applications that need to view it, a number of settings are available. The encryption settings to use depend upon how the potential global users will operate.

Important factors to consider when setting these options might be:

- Do all global user connections and operations require encryption?
- Will some global users be using older VNC viewer versions?

ServSwitch CX Quad IP encryption settings

The ServSwitch CX Quad IP configuration menu offers three encryption settings:

- **Always on** - This setting will force all viewers to use encryption. *Note: This setting will preclude any VNC viewer versions that do not support encryption.*
- **Prefer off** - This setting does not enforce encryption unless a viewer specifically requests it. If a viewer has its 'Let server choose' setting, then an un-encrypted link will be set up.
- **Prefer on** - This setting generally enforces encryption unless an earlier viewer version is unable to support it, in which case the link will be un-encrypted. If a viewer has its 'Let server choose' setting, then the link will be encrypted.

Viewer encryption settings

The web browser viewers and VNC viewers (of level 4.0b5S or higher) offer four encryption settings:

- **Always on** - This setting will ensure that the link is encrypted, regardless of the ServSwitch CX Quad IP encryption setting.
- **Let server choose** - This setting will follow the configuration of the ServSwitch CX Quad IP. If the ServSwitch CX Quad IP has 'Always on' or 'Prefer on' set, then the link will be encrypted. If the 'Prefer off' setting is selected at the ServSwitch CX Quad IP, then the link will not be encrypted.
- **Prefer off** - This setting will configure an un-encrypted link if the ServSwitch CX Quad IP will allow it, otherwise it will be encrypted.
- **Prefer on** - If the ServSwitch CX Quad IP allows it, this setting will configure an encrypted link, otherwise it will be un-encrypted.



INSTALLATION

CONFIGURATION

OPERATION

FURTHER INFORMATION

INDEX

Networking issues

Thanks to its robust security the ServSwitch CX Quad IP offers you great flexibility in how it integrates into an existing network structure. The ServSwitch CX Quad IP is designed to reside either on an internal network, behind a firewall/router or alternatively with its own direct Internet connection.



Positioning ServSwitch CX Quad IP in the network

Every network setup is different and great care needs to be taken when introducing a powerful device such as the ServSwitch CX Quad IP into an existing configuration. A common cause of potential problems can be in clashes with firewall configurations. For this reason the ServSwitch CX Quad IP is designed to be intelligent, flexible and secure. With the minimum of effort it can reside either behind the firewall or alongside with its own separate Internet connection.

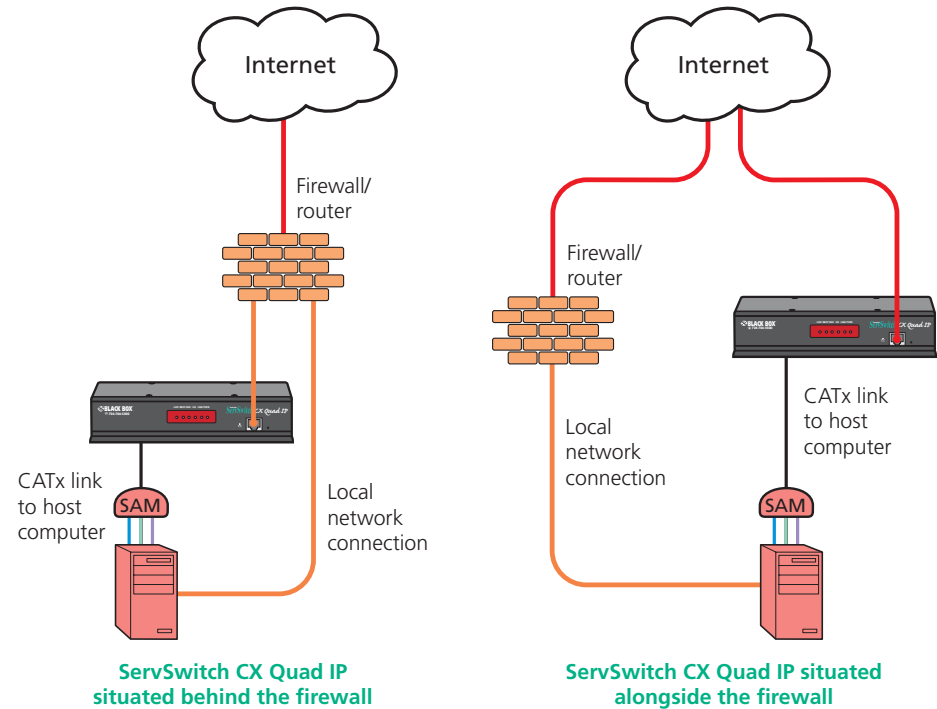

IMPORTANT: When the ServSwitch CX Quad IP is accessible from the public Internet connection, you must ensure that sufficient [security measures](#) are employed.

INSTALLATION

CONFIGURATION

OPERATION

FURTHER INFORMATION

INDEX

Placing ServSwitch CX Quad IP behind a router or firewall

A possible point of contention between the ServSwitch CX Quad IP and a firewall can occasionally arise over the use of IP ports. Every port through the firewall represents a potential point of attack from outside and so it is advisable to minimize the number of open ports. The ServSwitch CX Quad IP usually uses two separate port numbers, however, these are easily changeable and can even be combined into a single port.

IMPORTANT: The correct configuration of routers and firewalls requires advanced networking skills and intimate knowledge of the particular network. Black Box cannot provide specific advice on how to configure your network devices and strongly recommend that such tasks are carried out by a qualified professional.

Port settings

As standard, the ServSwitch CX Quad IP uses two [ports](#) to support its two types of viewer:

- **Port 80** for users making contact with a web browser, and
- **Port 5900** for those using the VNC viewer.

When these port numbers are used, VNC viewers and web browsers will locate the ServSwitch CX Quad IP correctly using only its network address. The firewall/router must be informed to transfer any traffic requesting these port numbers through to the ServSwitch CX Quad IP.

When a web server is also on the local network

Port 80 is the standard port used by web (HTTP) servers. If the ServSwitch CX Quad IP is situated within a local network that also includes a web server or any other device serving port 80 then, if you want to use the web browser interface from outside the local network environment, the HTTP port number of the ServSwitch CX Quad IP may need to be changed.

When you change the HTTP port to anything other than 80, then each remote browser user will need to specify the port address as well as the IP address. For instance, if you set the HTTP port to '8000' and the IP address is '192.168.47.10' then browser users will need to enter:

http://192.168.47.10:8000

(Note the single colon that separates the IP address and the port number).

The firewall/router would also need to be informed to transfer all traffic to the new port number through to the ServSwitch CX Quad IP.

If you need to change the VNC port number

If you change the VNC port to anything other than 5900, then each VNC viewer user will need to specify the port address as well as the IP address. For instance, if you set the VNC port to '11590' and the IP address is '192.168.47.10' then VNC viewer users will need to enter:

192.168.47.10::11590

(Note the *double* colons that separate the IP address and port number).

The firewall/router would also need to be informed to transfer all traffic to the new port number through to the ServSwitch CX Quad IP.

Addressing

When the ServSwitch CX Quad IP is situated within the local network, you will need to give it an appropriate local IP address, IP network mask and default gateway. This is achieved most easily using the DHCP server option which will apply these details automatically. If a DHCP server is not available on the network, then these details need to be applied manually in accordance with the network administrator.

The firewall/router must then be informed to route incoming requests to port 5900 or port 80 (if available) through to the local address being used by the ServSwitch CX Quad IP.

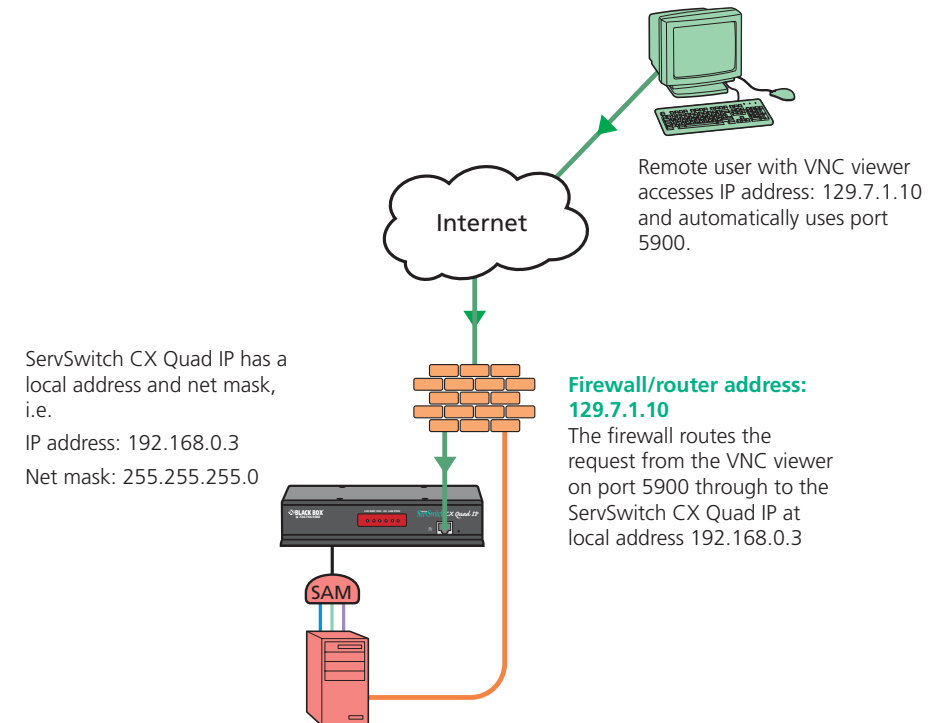



To discover a DHCP-allocated IP address

Once a DHCP server has allocated an IP address, you will need to know it in order to access the ServSwitch CX Quad IP via a network connection. To discover the allocated IP address:

- 1 In network section of either the [local configuration menus](#) or the [global configuration pages](#), set the 'Use DHCP' option to 'Yes' and select 'Save'. Once the page is saved, the ServSwitch CX Quad IP will contact the DHCP server and obtain a new address.
- 2 Re-enter the same 'Network configuration' screen where the new IP address and network mask should be displayed.

DNS addressing

As with any other network device, you can arrange for your ServSwitch CX Quad IP to be accessible using a name, rather than an IP address. This can be achieved in two main ways:

- For small networks that do not have a DNS (Domain Name System) server, edit the 'hosts' files on the appropriate remote systems. Using the hosts file, you can manually link the ServSwitch CX Quad IP address to the required name.
- For larger networks, declare the IP address and required name to the DNS server of your local network.

The actual steps required to achieve either of these options are beyond the scope of this document.

INSTALLATION

CONFIGURATION

OPERATION

FURTHER INFORMATION

INDEX



Placing ServSwitch CX Quad IP alongside the firewall

The ServSwitch CX Quad IP is built from the ground-up to be secure. It employs a sophisticated 128bit public/private key system that has been rigorously analyzed and found to be highly secure. Therefore, you can position the ServSwitch CX Quad IP alongside the firewall and control hosts that are also IP connected within the local network.

IMPORTANT: If you make the ServSwitch CX Quad IP accessible from the public Internet, care should be taken to ensure that the maximum security available is activated. You are strongly advised to enable encryption and use a strong password. Security may be further improved by restricting client IP addresses, using a non-standard port number for access.

Ensuring sufficient security

The security capabilities offered by the ServSwitch CX Quad IP are only truly effective when they are correctly used. An open or weak password or unencrypted link can cause security loopholes and opportunities for potential intruders. For network links in general and direct Internet connections in particular, you should carefully consider and implement the following:

- Ensure that encryption is enabled.
By [local configuration menu](#) or [global configuration page](#).
- Ensure that you have selected secure passwords with at least 8 characters and a mixture of upper and lower case and numeric characters.
By [global configuration page](#).
- Reserve the admin password for administration use only and use a non-admin user profile for day-to-day access.
- Use the latest Secure VNC viewer (this has more in-built security than is available with the Java viewer). To [download the viewer](#).
- Use non-standard [port numbers](#).
- Restrict the range of IP addresses that are allowed to access the ServSwitch CX Quad IP to only those that you will need to use. To [restrict IP access](#).
- Do NOT Force VNC protocol 3.3.
- Ensure that the computer accessing the ServSwitch CX Quad IP is clean of viruses and spyware and has up-to-date firewall and anti-virus software loaded that is appropriately configured.
- Avoid accessing the ServSwitch CX Quad IP from public computers.

Security can be further improved by using the following suggestions:

- Place the ServSwitch CX Quad IP behind a firewall and use the port numbers to route the VNC network traffic to an internal IP address.
- Review the activity log from time to time to check for unauthorized use.
- Lock your server consoles after they have been used.

A security white paper that gives further details is available upon request from Black Box.

Ports

In this configuration there should be no constraints on the port numbers because the ServSwitch CX Quad IP will probably be the only device at that IP address. Therefore, maintain the HTTP port as 80 and the VNC port as 5900.

Addressing

When the ServSwitch CX Quad IP is situated alongside the firewall, it will require a public static IP address (i.e. one provided by your Internet service provider).

More addressing information:

[Discover DHCP-allocated addresses](#)

[DNS addressing](#)

INSTALLATION

CONFIGURATION

OPERATION

FURTHER INFORMATION

INDEX

Power switching configuration

Power switch configuration comprises two main steps:

- Configure the **OPTIONS** serial port to the same speed as used by the power switch box(es), using the [configuration menu](#).
- Configure power ON and OFF strings for each relevant host computer.

For each power port there needs to be a valid 'Power ON string' and similarly an appropriate 'Power OFF string'. In each case, the strings are a short sequence of characters that combine a port address and a power on or off value.

If a particular computer has more than one power input (and thus requires an equivalent number of power ports to control them), collections of strings can be combined to switch all of the required ports together as a group.

To configure the power sequences for each host computer

- 1 Using VNC viewer or a browser, log on as the 'admin' user.
- 2 Click the 'Configure' button in the top right corner.
- 3 Click the 'Host configuration' option.
- 4 Click a host entry to display a Host configuration dialog:
- 5 If necessary, configure other parameters (Name, Users, Hot Keys - [MORE](#)).

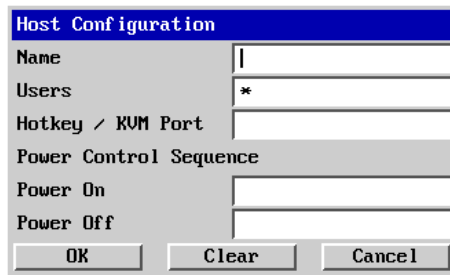

- 6 Enter the **Power control sequences** in the Power On and Power Off fields ⇒
- 7 Click OK to close the dialog and then click the Save button in the main Host Configuration window to store the details.

Power control sequences

Note: The settings given below are for one particular model of power switch - other power switches may require different settings. Please refer to your power switch documentation for details about codes required by other power switches.

The structure of each power sequence (OFF and ON) is as follows:

$Pxy=z\backslash0D$

Where:

- x** is the switch box number,
- y** is the power port number,
- z** is '0' for OFF or '1' for ON, and
- \0D** represents Enter (or Carriage return).

Example 1

To switch ON port 5 of switch box 2, the code would be as follows:

- Power sequence: $P25=1\backslash0D$

Example 2

To switch OFF port 8 of switch box 3, the code would be as follows:

- Power sequence: $P38=0\backslash0D$

For details about operating this feature, see [Power switching control](#) within the Operation chapter.

To control two or more ports simultaneously

You can control up to four power ports using a single sequence. This is done using the same command structure as shown above, plus a delay command, for each port. Immediately following a port command, insert the characters '*' before the next port command, and so on up to four ports. For instance, to switch on ports 1 and 2 in the first power switch, the command line would be:

$P11=1\backslash0D\ast P12=1\backslash0D$



Upgrading ServSwitch CX Quad IP models

The ServSwitch CX Quad IP models are upgraded via global connection (through the IP network port). Upgrades are digitally signed by Black Box using a secure key. This prevents unauthorized or altered firmware images being downloaded into the ServSwitch CX Quad IP.

To upgrade ServSwitch CX Quad IP models

- 1 Download the latest firmware revision for the ServSwitch CX Quad IP from Black Box technical support and decompress the download file. View the decompressed files and make a note of the name and location of the *.bin* file that was part of the download file collection.
- 2 Make a [global connection](#) to the ServSwitch CX Quad IP unit and login as the admin user.
- 3 Once logged in, click the 'Configure' button in the top right corner of the window.
- 4 Click the 'Unit Configuration' button.
- 5 Click the 'Advanced Unit Configuration' button.
- 6 Click the 'Upgrade Firmware' button. This dialog will be displayed:

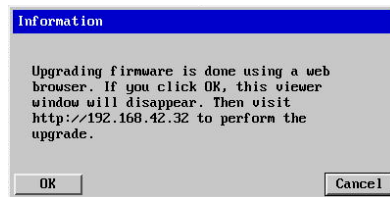

- 7 Click OK. The ServSwitch CX Quad IP is now ready to accept the upgrade files. Open your browser and connect to the ServSwitch CX Quad IP using the IP address that was confirmed in the dialog. Once connected, the ServSwitch CX Quad IP will offer the following screen:

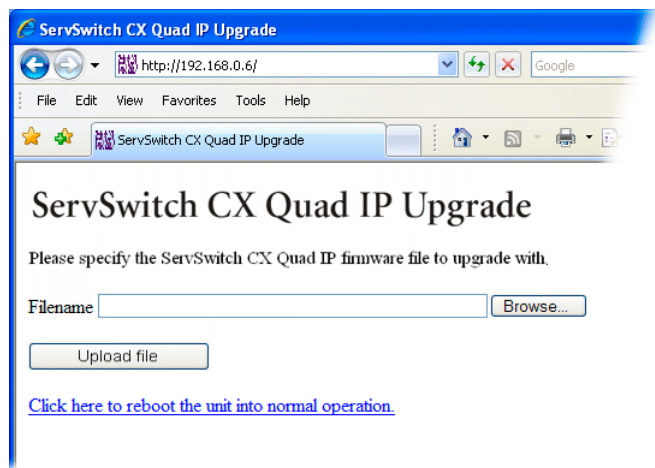

- 8 Click the 'Browse' button and locate the *.bin* upgrade file that you downloaded earlier. Click the 'Upload file' button. The ServSwitch CX Quad IP will next show the following screen:

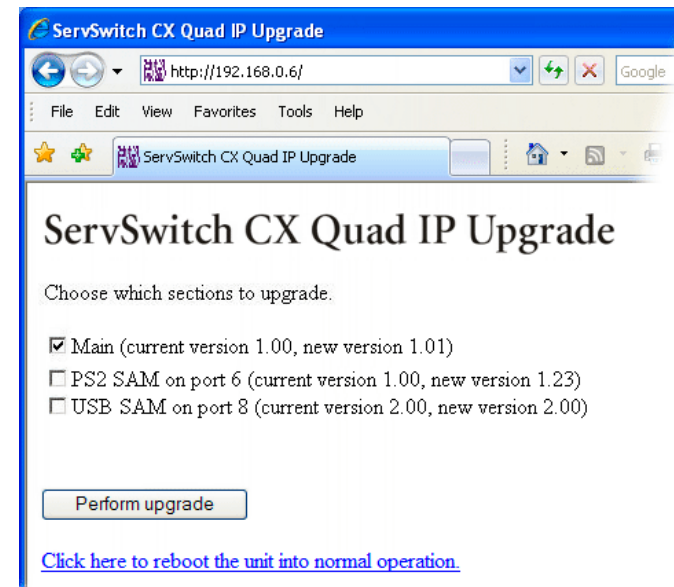

- 9 Select which portion of the ServSwitch CX Quad IP that you wish to upgrade:
 - Tick the 'Main' option to upgrade the ServSwitch CX Quad IP unit itself.
 - Tick one or more of the SAM options to include them in the upgrade process.
- 10 When ready, click the 'Perform upgrade' button. The upgrade will take place and its progress will be shown on screen.
- 11 When the upgrade is complete, click the link 'Click here to reboot the unit into normal operation'.

Recovering from a failed upgrade

If a problem is encountered while upgrading the ServSwitch CX Quad IP, it is still possible to restart the unit and attempt a new upgrade process.

To invoke backup/recovery mode

- 1 Remove power, press and hold the reset button (insert a thin implement such as a straightened paper clip into the small hole next to the IP connector) and then re-apply power. Then, release the reset button
- 2 Access the ServSwitch CX Quad IP using a web browser on an IP connected system. When the upgrade page is displayed, follow the normal instructions, except after step 10, remove and replace the power on the unit.



Operation



Accessing the ServSwitch CX Quad IP

The ServSwitch CX Quad IP provides two ways to gain access:

- [Local user access](#), or
- [Global user access](#) via IP network link.

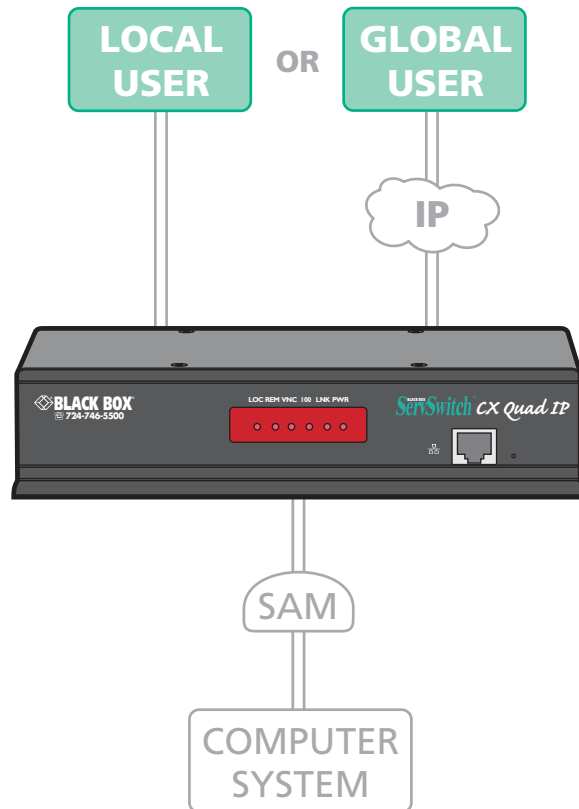

The front panel indicators

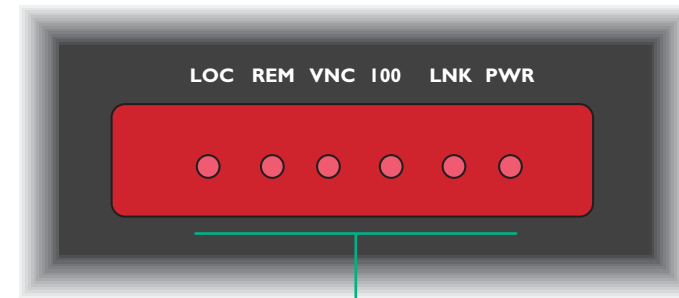

Indicators

- **LOC** Keyboard or mouse data are being received from the local console.
- **REM** Keyboard or mouse data are being received from a remote (global) viewer.
- **VNC** Indicates that a global user is connected and active.
- **100** Indicates the Ethernet network speed (10/100Mbps).
- **LNK** Indicates that a network link is present.
- **PWR** Indicates that power is present.

INSTALLATION

CONFIGURATION

OPERATION

FURTHER INFORMATION

INDEX

Local user access

To gain access as a local user:

- 1 From the local keyboard, press any key to display the login prompt:

If the above login prompt is not displayed, you are either already logged in to the ServSwitch CX Quad IP unit, or the security features have not been enabled. In such cases see 'To view this menu at any time' below.

- 2 Enter your username and password. Providing you have the correct permissions, the screen will display the Select Host menu, showing you a list of computers for which you have permission to access:

Computer	Port	Status
Computer 01	01	●
Computer 02	02	●
Computer 03	03	●
Computer 04	04	●
Computer 05	05	●
Computer 06	06	●
Computer 07	07	●
Computer 08	08	●

User: admin Status: Shared

F1 - more menus F3 - Find
ESC - Quit F4 - Logout

To view this menu at any time: Press and hold the hotkeys (usually **Ctrl** and **Alt**), then press **M** and finally release all three keys.

*Note: The **Ctrl** and **Alt** keys when pressed in combination are called 'hotkeys' and they signal to the ServSwitch CX Quad IP that you wish to control it, rather than the host computer. However, if these particular hotkeys clash with another device or program, then your administrator may change them to a different combination. If the **Ctrl** **Alt** **M** combination fails to work, then please contact your system administrator for details.*

To move the menu (and login) box position

- 1 While viewing any menu, press and hold the hotkeys (usually **Ctrl** and **Alt**).
- 2 Press the **↓**, **↑**, **←** and **→** keys to move the menu to the required position.

Note: The new menu position will be used until power is next re-applied.

Selecting a computer

There are three main ways for local users to select a specific computer channel:

- Using hotkeys (as described below) – this is a good method if you continually access a small number of computers.
- [Using the Select Host menu](#) – this is the best method when there are many connected computers.
- [Using mouse buttons](#) – this is a good method for cycling between a small number of computers.

For all methods (if the [confirmation box option](#) is enabled), when the required port is selected, a pop up message will be displayed to confirm the computer name or number, and its status. Alternatively, an error message explaining why a connection is not possible (press **Esc** to cancel the latter type of message).

To avoid the 'hall of mirrors' effect

IMPORTANT: Never configure a system so that your viewer is viewing itself.

When controlling a host computer via the local user port if the host computer is networked it is possible to make the VNC viewer or a browser to create a link back to itself via the global (IP) capabilities of the unit. This will set up a 'hall of mirrors' effect, where the computer is viewing itself into infinity.

While technically possible, the ServSwitch CX Quad IP unit is not designed to withstand this treatment and could sustain damage.

To select a computer using hotkeys

- 1 Simultaneously press and hold **Ctrl** and **Alt**.

*Note: The **Ctrl** and **Alt** keys when pressed in combination are called 'hotkeys' and they signal to the ServSwitch CX Quad IP that you wish to control it, rather than the computer. However, if these particular hotkeys clash with another device or program, then your administrator may change them to a different combination. If the **Ctrl** **Alt** combination fails to work, then please contact the system administrator for details.*

- 2 While still holding **Ctrl** and **Alt**, press the first numeral of the required port address, then:
 - If the port address is a single character, release all of the keys.
 - If the port address is two or more characters, release the first numeral key and press the second – repeat this procedure until all of the port address numerals have been entered, then release **Ctrl** and **Alt**.

Note: The numbers on your keyboard's numeric keypad are not valid, use only the numeral keys above the QWERTY section.

Note: If your user port does not have authorisation to view the selected port then an 'Insufficient user rights' messages will be displayed.

Note: When using hotkeys, the leading zeros for all single digit port numbers (including all cascade levels) are optional, i.e. 01, 02...09.



Standard hotkeys

The range of hotkey combinations are as follows:

*Note: If your hotkeys have been changed, substitute them for **Ctrl** and **Alt** in the examples given here.*



Selects port 1



Selects port 2



Selects port 10

*Note: When entering multiple digit addresses as above, keep **Ctrl** and **Alt** pressed down until all other numbers have been entered.*



Selects the next available port



Switches off the video signal – this will cause a power saving monitor to enter its standby mode. To awaken the monitor, simply select any fixed channel using any of the suggested methods.



Logs out the current user (if security is enabled) or selects port 0 to disable the video signal (if security is disabled).



Moves the currently displayed on-screen menu around the screen.

To select a computer using the Select Host menu

1 Display the Select Host menu in one of two ways:

- By simultaneously pressing and then releasing **Ctrl**, **Alt**, **M**, or
- By pressing the middle and right buttons of a three button mouse.

Note: The mouse switching option is usable only if the 'Mouse Switching' option is enabled. See [Global preferences](#) for more details.

At this point, depending on the security settings and the current log in situation, one of two things will be displayed, either the login screen, or the Select Host menu:

CX Quad IP Select Host	
Computer	Port
Computer 01	01
Computer 02	02
Computer 03	03
Computer 04	04
Computer 05	05
Computer 06	06
Computer 07	07
Computer 08	08

User	Status
admin	Shared

F1 - more menus F3 - Find
ESC - Quit F4 - Logout

The Select Host menu – here you can select computers by name.

- 2 Use the **↓** and **↑** keys (or the scroll wheel of an IntelliMouse) to highlight the required computer name. Alternatively (for large configurations), press **F3** to perform an alphabetical search for a particular port name. You can also use the PgUp and PgDn keys to move up or down a full page of list entries at a time, or press the Home and End keys to quickly move to the beginning or end of the list, respectively.

Note: If security has been enabled then only computers to which the current user has permission will be displayed.

- 3 Press **↵** to select the highlighted port.

*Note: Pressing **↵** will select the highlighted port in shared mode (other users can also view the computer). To select the port in private mode, press **Shift** and **↵** when choosing.*





To select a computer using mouse buttons

Note: This procedure works only with three-button or IntelliMouse devices and only if the 'Mouse Switching' option has been enabled by your administrator.

- 1 Hold down the middle button (or scroll wheel) of the mouse.
- 2 Click the left mouse button to select the next computer port. When the correct port is reached, release the middle button.

*Note: Clicking the left mouse button will select the highlighted port in shared mode (other users can also view the computer). To select the port in private mode, hold **[Shift]** and then click the left mouse button.*

Note: If security has been enabled then only computers to which you have permission will be displayed.

To select a computer using mouse buttons – Advanced method

- 1 Select the on-screen menu by pressing the middle and right buttons of a three button mouse.
- 2 Use the scroll wheel to highlight the required computer port.
- 3 Then, select either:
 - *Shared Use* - press the left mouse button - This *standard* method allows other users to view the same computer port. Control of the port is given to one user at a time, on a first-come, first-served basis and is relinquished after a certain period of inactivity.
 - *Escape without selecting a port* – press the right mouse button.

Show All Users

At any time you can view a list of which users are logged-in and the host computers that they are currently accessing. This can be particularly useful if you find that the host to which you need access is already being viewed in private by another person.

To view the show all users list

- 1 From a local keyboard, log on as a standard or 'admin' user.
- 2 Press **[Ctrl]** **[Alt]** **[M]** (hotkeys can change).
- 3 Press **[F1]** to show the Main Menu.
- 4 Select 'Functions' and press **[Enter]**.
- 5 Select 'Show All Users' and press **[Enter]**.

CX Quad IP Show All users		
User		
admin		
Host		Port
Computer 02		02
User		
support		
Host		Port
Computer 05		05
User		
sales		
Host		Port
<none>		

Logging in and out

The ServSwitch CX Quad IP features a straightforward security system that helps to prevent unauthorized access to some, or all connected computers.

If the security option has been selected by your administrator then you will be asked to enter a *User Name* and *Password* when you first access a user port. When you have finished using the computer, it is then good practice to logout, forcing any other users to authenticate themselves prior to use.

Note: If the security option has not been enabled then no login is required.

To log in

- 1 If it is not already displayed, move the mouse or press any key to display the log in screen.

- 2 Enter your designated *User Name* and press **[Enter]**.
- 3 Enter your designated *Password* and press **[Enter]**. If both entries are correct then the selected port will be displayed.

Note: If either the User Name or Password are incorrect, the entries will be cleared to allow another attempt.

To log out

Either:

- Press **[Ctrl]** **[Alt]** and **[L]** at any time to log out.

or

- 1 Display the Select Host menu in either of two ways:
 - By simultaneously pressing and then releasing **[Ctrl]** **[Alt]** **[M]**.
*Note: The **[Ctrl]** and **[Alt]** hotkeys may have been changed. If the combination fails to work, then please contact the system administrator for details.*
 - By pressing the middle and right buttons of a three button mouse, or
- 2 Press **[F4]**. You will be logged out and the screensaver will be displayed. Press a key or move the mouse to re-display the login window.



The confirmation (status) box

The ServSwitch CX Quad IP provides the option of a confirmation box that is displayed on screen for three seconds after a computer is selected. The confirmation box indicates the current user port and your user name, the selected computer and the connection status. You can enable or disable the confirmation box, as required.

CX Quad IP Status	
Computer	Port
Computer 01	01
User	Status
admin	Shared

To enable/disable the confirmation box

1 Display the Select Host menu in one of two ways:

- By simultaneously pressing and then releasing   , or
- By pressing the middle and right buttons of a three button mouse.

If you are not already [logged in](#), do so now.

2 Press  to select 'More menus'.

3 Highlight the 'User Preferences' option and press  to select.

4 Highlight the 'Confirmation Box' option and press  to select 'Enabled' or 'Disabled', as required.

5 Select the 'Save' button to return to the previous menu.

User preferences and functions

In addition to enabling or disabling the confirmation box, you can also:

- Select the screen saver style,
- Restore mouse operation, or
- Perform power control functions.

All of these options are discussed within [Appendix 1](#).





Orange dot indicators in the Select Host menu

Within the Select Host menu, each listed host has a coloured dot associated with it to indicate its general status: Green for accessible and Red for inaccessible.

CX Quad IP Select Host		
Computer	Port	
Computer 01	01	●
Computer 02	02	●
Computer 03	03	●
Computer 04	04	●
Computer 05	05	●
Computer 06	06	●
Computer 07	07	●
Computer 08	08	●

Legend:

- Green: Host accessible
- Red: Host inaccessible
- Orange: Inconsistency related to a cascade connection.

User: admin Status: Shared
F1 - more menus F3 - Find
ESC - Quit F4 - Logout

There is, however, a third state where the dot turns Orange. An orange dot against a host entry indicates that an inconsistency relating specifically to cascaded hosts.

The problem can occur for two main reasons, either:

- A cascaded computer (or multiple computers) has been added to an address such as 0301, however, there is still a registered entry for a directly connected host at address 03. Thus, the now non-existent host at 03 will be marked with an orange dot.
- A previously connected cascade has been removed and a computer connected directly instead. This will cause all of the entries for the removed cascaded hosts to be marked with orange dots. If they are not to be reinstated, then the administrator should delete the entries.

If you attempt to select an entry marked with an orange dot (by the menu, by hotkeys or from the VNC viewer) you will see an error message stating 'computer not connected'.

INSTALLATION
CONFIGURATION
OPERATION
FURTHER INFORMATION
INDEX

Global user access

Global users access the ServSwitch CX Quad IP using a viewer and a network/internet link. There are two types of viewer: a standalone VNC viewer or a VNC Java application used within a standard web browser.

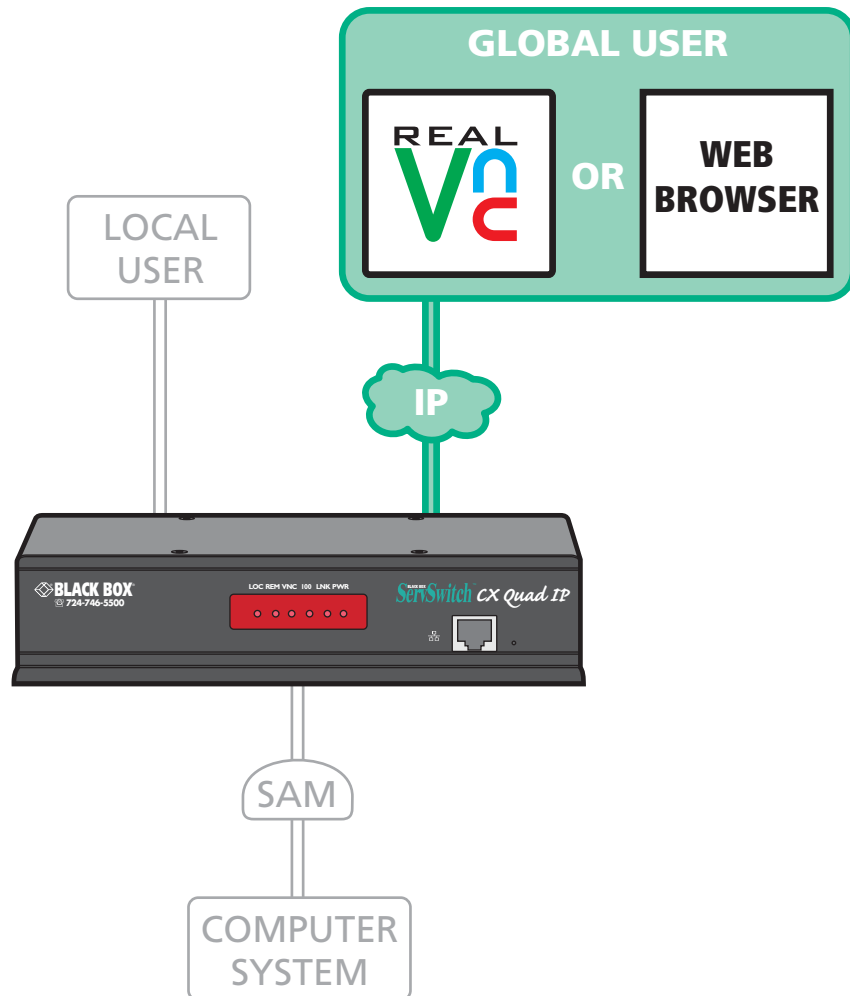

Select the required viewer

What will I see when I first login?

When you login to a VNC session, the result that you first see will depend on the status of your username account:

- If you are using your username for the first time then no host will be initially selected. Click the Hosts button to view a list (see [Host selection](#) for details).
- If you have previously been logged in, the last host computer that you viewed will be shown.
- If your username is already logged in at another location, then the host computer currently being viewed in the existing session will be shown.

How do multiple users coexist?

Each of the four global users and also the local user can view any host computer for which they have permission. More than one user can view the same host and potential conflicts are arbitrated in the following ways:

- If a user views a host in private mode and then switches to a new host, then the new host will also be viewed in private.
- If a user is viewing a host in shared mode when another user chooses the same host but in private mode, the first user's view will be blanked and a message indicating that another user has taken private access will be given.
- If a user views a host in private mode and another user chooses the same host, the second user will see a message indicating that the host is already being viewed in private mode.
- If multiple users are viewing the same host and one switches to another host then only that user moves to the new host, all other users are unaffected.



INSTALLATION

CONFIGURATION

OPERATION

FURTHER INFORMATION

INDEX

Global user access via VNC viewer

The VNC viewer is a compact application that runs on your IP-connected 'global' system and allows you to view and use the ServSwitch CX Quad IP and its host computer(s). VNC viewer is readily available from a number of different sources:

- from the ServSwitch CX Quad IP installation CD
- from the ServSwitch CX Quad IP itself
- from the [RealVNC website](#)

To access via the VNC viewer

- 1 Locate and select the VNC viewer icon ⇒



A connection details dialog will be displayed:

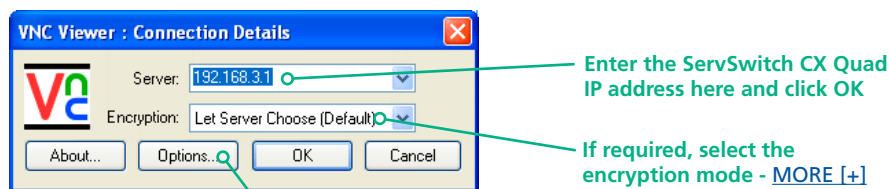

Options button

Provides a range of viewer and connection settings - [MORE \[+\]](#)

- 2 In the 'Server:' entry, type the address of the ServSwitch CX Quad IP as follows:

v.w.x.y

where v.w.x.y is the IP network address, for example 192.168.0.3

- [If you have been asked to also enter a port number.](#)

- 3 Click the OK button. Depending on the options selected, you may need to confirm certain items. A connection attempt will be made and if successful, an authentication dialog will be displayed:

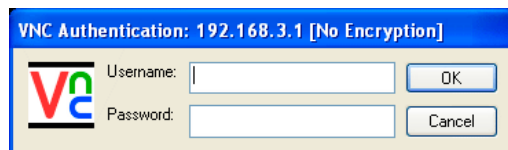

- 4 Enter your Username and Password. The [viewer window](#) should now open and show the current host computer. *Note: If the Username entry is blanked out then only admin user account is currently defined and only a password is required.*

Downloading VNC viewer from the ServSwitch CX Quad IP

The ServSwitch CX Quad IP has the ability to distribute its own VNC viewer application.

To download the VNC viewer

- 1 Open your Web browser.
- 2 Enter the network address where the ServSwitch CX Quad IP is situated (in the form: <http://192.168.0.3>) and make the link.
- 3 In the opening ServSwitch CX Quad IP screen, click the link that offers to download the secure VNC viewer 'from the unit'.
- 4 Save the download file (vncviewer.exe) to your system.
- 5 Select and run the downloaded file and then connect to the ServSwitch CX Quad IP using the VNC viewer application.

IMPORTANT: During login, if you see a warning message similar to the one shown here, then **stop** and do not proceed.

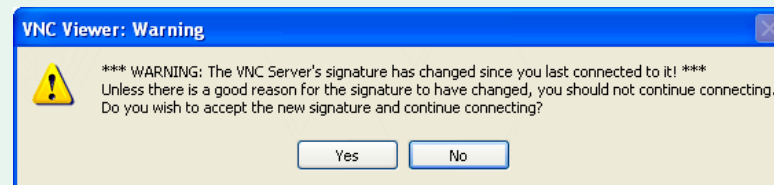

This message is displayed if an ServSwitch CX Quad IP unit that your viewer has previously visited, has had a change of security keys. This is not uncommon if a unit is reset for some reason. However, it could also mean that your trusted unit is being spoofed and you may not be connecting to the system that you think you are.

Do not click the Yes button until you have checked with your administrator that the trusted ServSwitch CX Quad IP unit has been recently reset for some reason.



Global user access via web browser

You can use a standard Web browser ([supported versions](#)) to gain access to the ServSwitch CX Quad IP and its host computer(s). As soon as you make contact with the ServSwitch CX Quad IP it will begin downloading a small Java application to your browser, which will be used only for the duration of your connection.

To access via your web browser

- 1 Launch your standard Web browser as usual.
- 2 In the Address section, type the address of the ServSwitch CX Quad IP as follows:

http://v.w.x.y

where v.w.x.y is the IP network address, for example 192.168.0.3

- [If you have been asked to also enter a port number.](#)

- 3 Press . A connection attempt will be made.
- 4 In the browser window, select the 'Connect using built-in Java VNC viewer' option to download a small application that will temporarily empower your browser (on slow connections the application download can take several tens of seconds to complete). Once complete, a connection details dialog will be displayed:

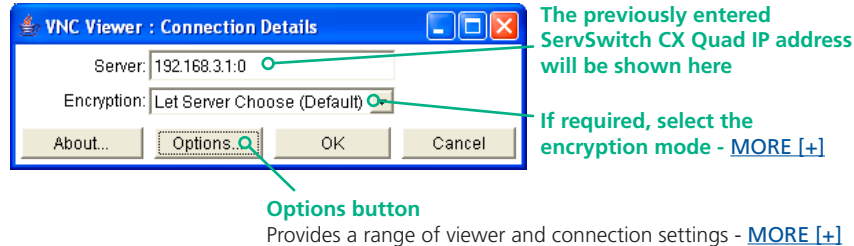

- 5 Make any necessary option/encryption changes and click the OK button to proceed. Depending on the options selected, you may need to confirm certain items.
- 6 A second connection attempt will be made and if successful, an authentication dialog will be displayed:

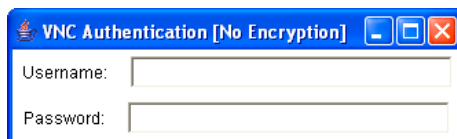

- 7 Enter your username and password. The [viewer window](#) should now open and show the current host computer. *Note: If the Username entry is blanked out then only admin user account is currently defined and only a password is required.*

IMPORTANT: During login, if you see a warning message similar to the one shown here, then **stop** and do not proceed.

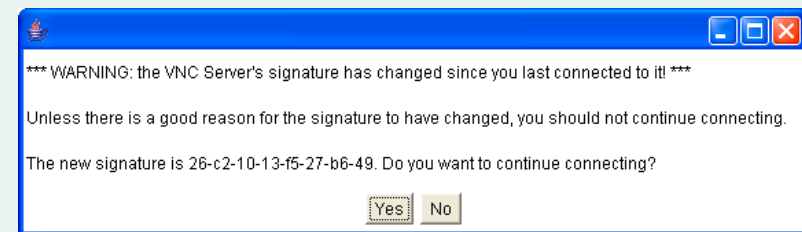

This message is displayed if an ServSwitch CX Quad IP unit that your viewer has previously visited, has had a change of security keys. This is not uncommon if a unit is reset for some reason. However, it could also mean that your trusted unit is being spoofed and you may not be connecting to the system that you think you are.

Do not click the Yes button until you have checked with your administrator that the trusted ServSwitch CX Quad IP unit has been recently reset for some reason.



Using the viewer window

The viewer window gives you the ability to view and control the ServSwitch CX Quad IP and its host computer(s). Its operation is almost identical regardless of whether you used the VNC viewer or your Web browser to display it.

The menu bar

The viewer window presents a menu bar similar to that shown below. Certain items within the toolbar are displayed depending upon your access permissions and/or the ServSwitch CX Quad IP configuration.

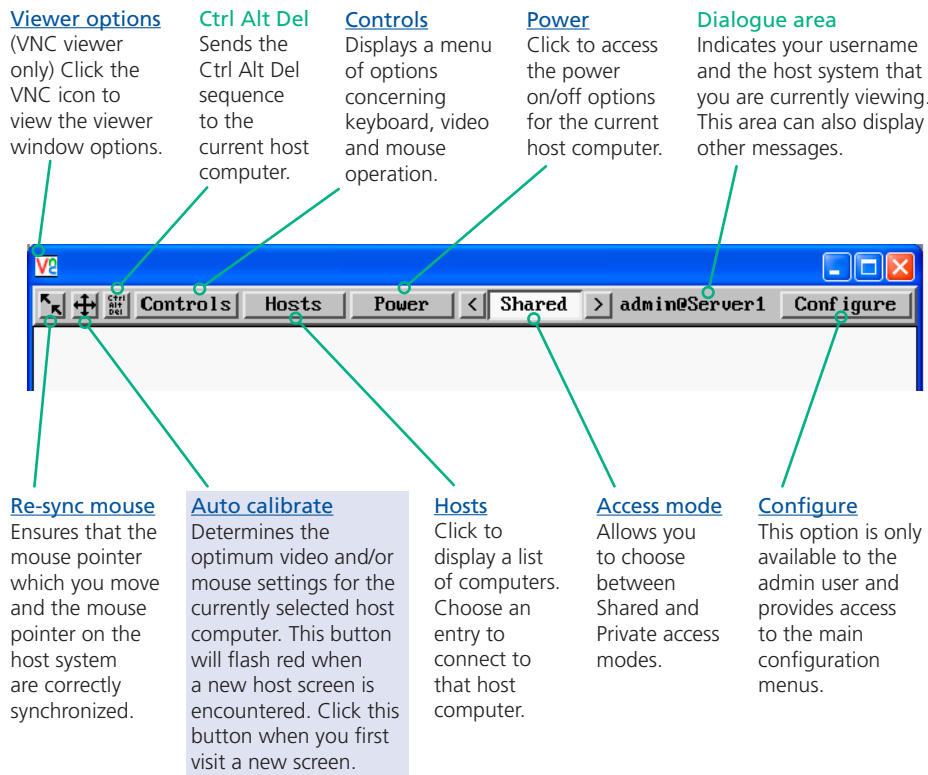

IMPORTANT: Optimal performance of the ServSwitch CX Quad IP is dependant on the calibration of the video for each host computer. For this reason, if you view an uncalibrated host, the unit will invoke an automatic calibration after a pause of roughly twenty seconds.

If the video is not calibrated the unit can operate slower than expected and will affect all users. If you experience a drop in performance on the VNC viewers, try recalibrating your viewer as a first step. Click the [Auto calibrate](#) button or access the [Video settings](#) option from the 'Controls' button.

When using the viewer window

What is the best screen resolution to use?

The best resolution for your computer is one that is larger than the screen of the host computer that you are viewing. This will allow you to see everything without scrolling around. Alternatively, the VNC viewer can be set to scale the image to fit your screen, but remember that some pixel dithering effect will be seen when scaling is used.

How do I navigate around a larger screen?

If the screen that you are viewing has a larger resolution than your viewing window you will need to scroll around to see all items. The viewer window allows you to 'bump scroll' (only in full screen mode). This means that when your mouse cursor bumps against the edge of the screen, the screen image will scroll across automatically.

How do I escape from full screen mode?

Press the F8 button. This button is changeable but is most often set to F8.

Why is the button flashing red?

This happens when a new host screen is viewed (that has not been viewed before). Click the  button to perform an auto calibration for the screen and the mouse. See [Auto calibrate](#) for important information about this feature.

How do I change between host computers?

You can either click the 'Hosts' button to select a host by name (see [Host selection](#)) or use hotkey presses to choose a host by its port number (see [VNC Hotkey selection](#)).

How do I remove traces of moved items from the screen?

When you move an item or window across the screen, sometimes it can leave unsightly trails. These are called *artifacts* and can be particularly prevalent when the connection speed is low. To remove artifacts, click the 'Controls' button and select the 'Refresh screen' option. See [Controls](#).

How do I make the most of a slow connection?

The VNC viewer is slightly better suited to slower connections than the browser viewer because it offers more options. Click the [Options](#) button of the VNC viewer when entering the ServSwitch CX Quad IP address during log on.

Adjust the Threshold setting

Ensure that the video [Threshold setting](#) is set higher than the automatic setting suggests. Tweak this setting manually to ensure the best setting.

Fewer colours

Select the [Low \(64 colours\)](#) mode. The Very low option offers hardly any improvement and looks a lot worse.

Rate limit mouse events

When selected, this mode greatly reduces the mouse movement data that are sent to the host computer. When you move the local mouse, the remote cursor will catch up roughly once per second.



Mouse pointers

Both viewers provide a double mouse cursor to help overcome any delays caused by slow connections. When you move your mouse you will see two mouse cursors, a local one that responds immediately to your movements and a second, slower moving, cursor that represents the current mouse position at the host.

For the browser viewer, the local cursor is a typical arrow:

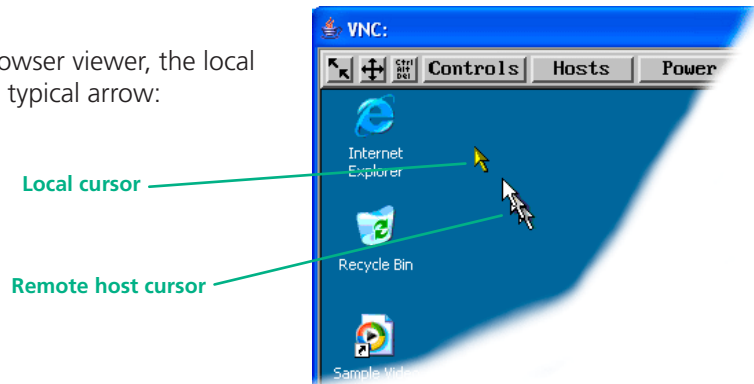

For the VNC viewer, the local cursor is a dot:

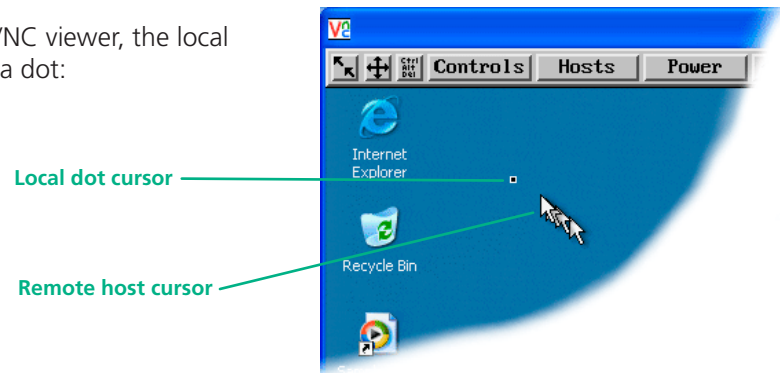

Additionally, for fast network connections, the VNC viewer also provides a single mouse mode. See [Controls - Single Mouse](#) for details.

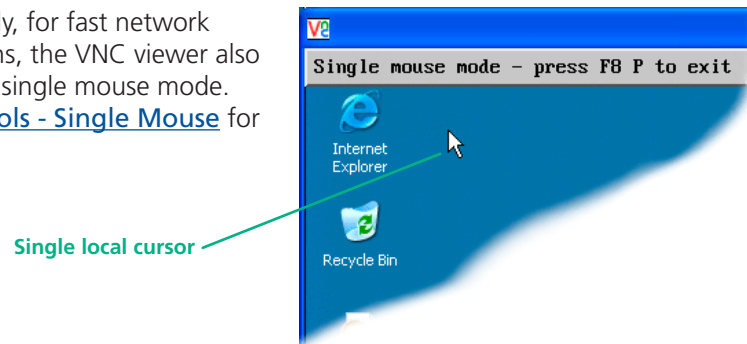

Host selection

The Hosts button on the menu bar provides the quickest and most efficient way to switch between host computers. This is because the button is close at hand, but also because the screen calibration details for each host are reused when this method of switching is used. The alternative is to use [hotkey combinations](#) or the ServSwitch CX Quad IP [on-screen menu](#).

To select a host

- 1 Click the Hosts button to display a list of computers.
 - 2 Click the required computer name to view and control it.
- You can use the List Order option to determine whether the hosts are listed by their entry number or alphabetically.

See [Appendix 2 - Host configuration](#) for details about programming new hosts into the ServSwitch CX Quad IP ('admin' user status required).

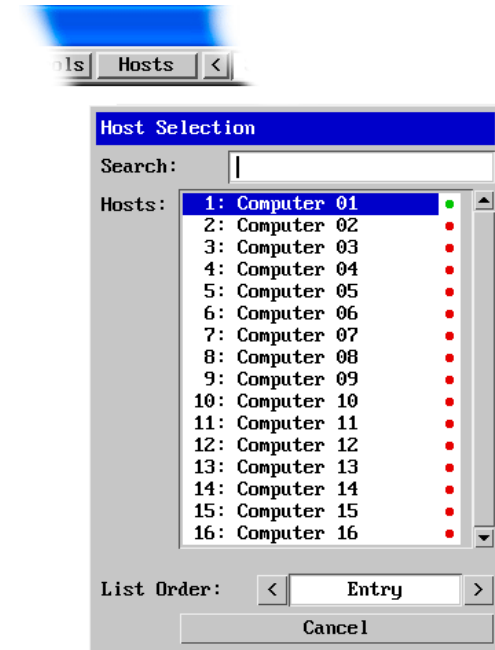

Configure

This option is displayed only when you are logged on as the 'admin' user. When selected it provides access to a wide range of ServSwitch CX Quad IP settings.

See [Appendix 2 - Configuration pages via viewer](#) for more details.





Auto calibrate

When you visit a host computer for the very first time, your viewer needs to determine the optimum video and mouse settings for that particular computer. The button will remind you to click it by flashing red when a new computer screen is encountered. Performing this step is important because it can help to decrease unnecessary video information being sent across the link, thus improving overall performance.

Once this has been done, providing you use the 'Hosts' button to switch between host computers, the video settings for each machine will be re-used.

Note: When performing an auto calibration, ensure that the screen image is static (no moving images) and also try to remove any on-screen displays generated by KVM switches (such as host names or menus). This is because they can affect the calibration process and result in a lower overall performance level. For mouse calibration, ensure that there are no application windows located around the upper left corner of the screen. This is because as the mouse calibration takes place, the cursor may change (to match the application as it skims across the window) and this may confuse the calculation. Also ensure that the host computer does not have the mouse cursor trails option enabled.

To auto calibrate the screen and/or mouse

- 1 Use the Hosts button to select the required computer.
- 2 Click the  button to display the Calibrate options dialog:
- 3 Click the required action.

A progress indicator will be displayed while the necessary calculations are made.

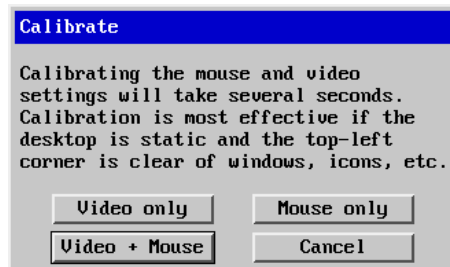

Upon completion an information dialog will explain the results:

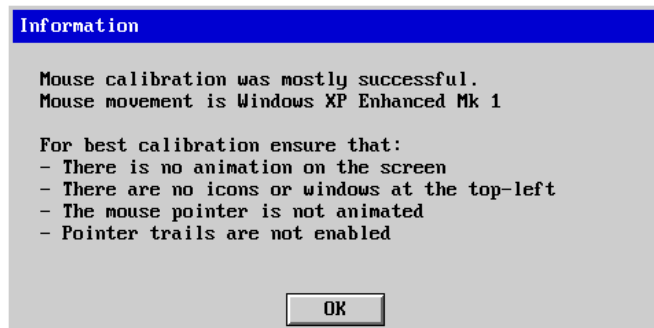

Re-synchronize mouse

If you find that your local mouse pointer and that of the host are not correctly synchronized, use this feature to re-align their movements. This operation is also selectable from the Controls menu.

To re-synchronize the mouse

- 1 Use the Hosts button to select the required computer.
- 2 Click the  button and then click OK in the subsequent pop-up message.
Note: If you find that this doesn't work, you may need to perform a mouse calibration again.

Access mode - shared/private

Up to five users can be simultaneously logged-in (four global users plus one local) and all can view the same or different hosts according to their permission status. If you need to perform a sensitive task that should not be viewed by other users, you can change the access mode to Private. This action blanks the viewer window for any user attempting to view the same host.

Note: For the courtesy of other users, this mode should be used sparingly. The admin user (or any user who has been given IsAdmin status - see [User accounts](#)) has the ability to overrule the private setting.

To change the access mode

- 1 Click one of the arrow buttons adjacent to the Shared/Private indicator.



Power switching

When configured (and where you have access rights) this option allows you to control the mains power input to the currently selected host computer.

Note: This option is generally used to power cycle remote systems that have failed to respond. Before switching a system off, ensure that all attempts have first been made to power it down through normal means.

To switch a system on or off

- 1 Use the Hosts button to select the required computer.
- 2 Click the Power button and then select the Switch on or Switch off option, as appropriate.

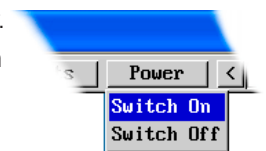



Controls

When clicked, this button reveals a menu of options concerned with keyboard, video and mouse operation.



Single Mouse Mode

This mode is for fast network connections where the cursor response is sufficient to provide instant visual feedback on the remote screen. When enabled, the cursor is 'captured' within the viewer window until you use the 'escape' hot keys.

To quit from single mouse mode, press F8 and then P. Alternatively, enable and use the mouse button escape sequences - see [Advanced unit configuration](#) for details.

The single mouse mode does not require calibration.

Resync Mouse

This option has the same effect as the  button on the menu bar and re-synchronizes the local and remote mouse pointers.

Refresh Screen

This option refreshes the whole screen image to remove any artifacts from moved screen items. This is useful when using very low refresh rates on slow speed communication links.

Info

When selected, this option displays an information dialog showing the current logged on users, the current host, its video mode and its mouse motion details.

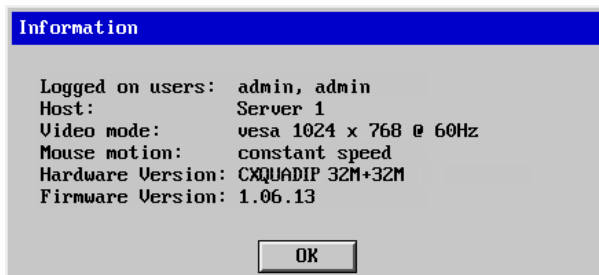

Mouse Control

This option displays a mouse control dialog and is useful when the remote cursor is failing to respond correctly to your mouse movements, even after using the Resync mouse option.

The mouse control dialog allows you to control the remote mouse cursor using a selection of buttons that you click with your local mouse.

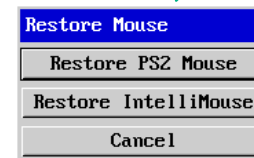
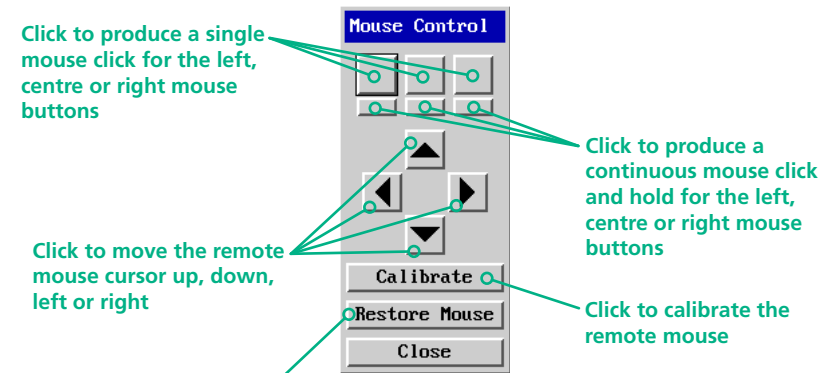

Click to display the Restore mouse dialog where you can reinstate a mouse that has failed to operate correctly.

continued



Keyboard Control

This option displays a keyboard control dialog and is useful for sending keyboard combinations (to the host) that are needed regularly or that are trapped by the ServSwitch CX Quad IP.

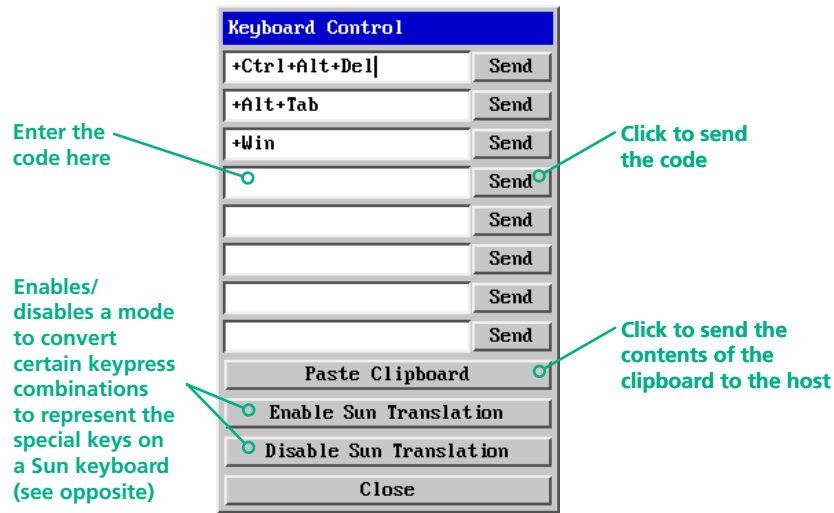

When entering codes:

- + means press down the key that follows
 - means release the key that follows
 - +- means press down and release the key that follows
 - * means wait 250ms (note: if a number immediately follows the asterisk, then the delay will equal the number, in milliseconds)
- It is automatically assumed that all keys specified will be released at the end, so there is need to specify -Ctrl or -Alt if these keys are to be released together.

See [Appendix 9](#) for a list of key sequence codes that can be used.

Examples:

- 'Ctrl + Alt 12' would be expressed as: +Ctrl+ Alt+1-1+2
- +N means press the 'N' key
- +Scroll means press the Scroll lock key
- +Space means press the space key

Video Settings

see [next page](#)

Enable Sun Translation

When enabled, this mode translates certain keyboard sequences to represent the special keys that are present on Sun keyboard. Use this when using a standard keyboard while connecting to a Sun system.

Notes:

The Enable/Disable status of the Sun translation mode is retained, so this mode selection only needs to be done once per host.

The mode selection only affects the host being viewed, so can be set differently for different hosts.

Standard keyboard

- Right-[Ctrl] [F1]
- Right-[Ctrl] [F2]
- Right-[Ctrl] [F3]
- Right-[Ctrl] [F4]
- Right-[Ctrl] [F5]
- Right-[Ctrl] [F6]
- Right-[Ctrl] [F7]
- Right-[Ctrl] [F8]
- Right-[Ctrl] [F9]
- Right-[Ctrl] [F10]
- Right-[Ctrl] [1]
- Right-[Ctrl] [2]
- Right-[Ctrl] [3]
- Right-[Ctrl] [4]
- Right-[Ctrl] [H]

Sun keyboard

- Stop
- Again
- Props
- Undo
- Front
- Copy
- Open
- Paste
- Find
- Cut
- Mute
- Volume -
- Volume +
- Power*
- Help

* Certain PS/2 keyboards have a power key which will be mapped to perform the same function for a Sun system.



Video Settings

This dialog provides access to all of the key video settings that determine image quality and link performance.

Threshold

The threshold is effectively a noise filter that differentiates between valid video signals and background noise or interference. This has the effect of reducing unnecessary video signals between the ServSwitch CX Quad IP and the remote system, thus improving performance.

Phase

The phase setting adjusts the alignment of the host video output and the remote system video display to achieve the sharpest image.

Horizontal Position

Determines the horizontal position of the host screen image within the viewer window.

Vertical Position

Determines the vertical position of the host screen image within the viewer window.

Custom Modes

See the next page.

Advanced

See the next page.



Brightness & Contrast

The red, green and blue constituents of the brightness and contrast can be set individually. Alternatively, use the Auto button on the right side to automatically optimize these for the current host and connection speed.

Calibrate All

Click to determine the optimum settings for all aspects of video the video connection from the host system.

Display activity

Indicates the level of video activity currently in progress.

Using automatic configurations

- Every setting can be individually subjected to an automatic configuration (click the appropriate 'Auto' button) or can also be manually adjusted.
- Use the 'Calibrate All' button to automatically determine the optimum settings for all items.

Note: Before using the 'Calibrate All' option, if possible, remove on-screen display (OSD) elements generated by the ServSwitch CX Quad IP (such as a menu). These OSD elements use different video rates to those of the host system(s) and can affect the setting of the automatic threshold value. ServSwitch CX Quad IP uses an improved calculation procedure to filter out the effect of these elements. However, best results are obtained when the screen contains only host system information.

Note: To maximize performance, the threshold level is automatically increased by 50% when a slow link is detected.

Note: When the ServSwitch CX Quad IP is used with one or more other switches, the threshold needs to be higher than 32 due to the signal 'noise' that these switches introduce. The ServSwitch CX Quad IP configuration should detect such noise and adjust the threshold accordingly.

Setting the Threshold manually

Occasionally it can be useful to manually adjust the Threshold setting, in order to achieve a setting that best suits your particular requirements.

- 1 Use the 'Calibrate All' function to ensure that all other settings are optimized.
- 2 Click the Threshold left arrow button to decrement the setting by one and observe the 'Display Activity' indicator.
- 3 Repeat step 2 until the Display Activity indicator suddenly rises to a much higher level (i.e. 50%). This will mean that you have reached the noise boundary. At this point, increment the Threshold value by 2 or 3 points to achieve an optimum setting.

IMPORTANT: Optimal performance of the ServSwitch CX Quad IP is dependant on the calibration of the video for each host computer. For this reason, if you view an uncalibrated host, the unit will invoke an automatic calibration after a pause of roughly twenty seconds.

If the video is not calibrated the unit can operate slower than expected and will affect all users. If you experience a drop in performance on the VNC viewers, try recalibrating your viewer as a first step.

Show All Users

Select this option to display a list of all users who are currently logged into the ServSwitch CX Quad IP unit together with the host computer (and port) that they are currently viewing.

Local User	Host	Port
admin	<none>	
UNC User: support	Computer 02	02
UNC User: admin	Computer 01	01

OK

Custom Video Modes

This option allows you to define non-standard video resolutions and refresh rates to suit your display characteristics.

Enter the horizontal and vertical pixels counts together with the refresh rate and, optionally the Reduced Blanking option (see below), then click the Calc button. Then click the Add button to include the new mode within the list. If you calculate the setting for a mode that has too high a resolution to be displayed full width, this dialog will calculate the values for a half-width version instead.

Reduced Blanking

The Reduced Blanking option can be enabled when using flat panel display monitors and helps to save bandwidth without any loss of performance. The blanking period is present in all standard video signals and is a small time delay to allow the beam of cathode ray tube displays to return to the top left corner of the screen. As flat panel displays do not have a beam, the blanking period can be removed.

Resolution: [] X [] @ [] Hz Calc

Reduced Blanking Edit Add

Custom Modes Remove Up Down

Save Cancel

Advanced Video Settings

This option contains video signal settings that do not normally need to be adjusted.

Pixel Format

Determines the colour depth and data required to represent each video pixel.

YUV / RGB

Determines the colour space used by the unit.

Advanced Video Settings

Pixel Format < 16bpp 555 >

Tile Width < 16 > Height < 16 >

YUV RGB

Save Timing Details Cancel

Tile Width and Height

Determines the size of the sample areas into which the source video screen is divided for examination purposes. Smaller sizes result in more areas to sample, larger areas result in more frequent screen area refreshes. 16 is considered to be the optimum size for both the width and height settings.

Timing Details

Click this button to display information that is useful when debugging video problems.

Information

Detected Mode
Horizontal Period 15.625us Polarity Positive
Vertical Period 16.698ms Polarity Positive

Selected Mode: vesa 1280 x 1024 @ 60Hz
Horizontal Period 15.630us Polarity Positive
Vertical Period 16.661ms Polarity Positive

Error from detected mode 0.25%

Selected Mode details
Pixel clock 108.000 MHz

	Disp	Front Porch	Sync	Back Porch
Horizontal	1280	48	112	248
Vertical	1024	1	3	38

OK



INSTALLATION

CONFIGURATION

OPERATION

FURTHER INFORMATION

INDEX



VNC hotkey selection

During a VNC session, you can use hotkey presses to quickly display the Host selection menu or to choose a host by its port number:

To select a computer using hotkeys

- 1 Simultaneously press and hold and .

Note: The and keys when pressed in combination are called 'hotkeys' and they signal to the ServSwitch CX Quad IP that you wish to control it, rather than the computer. However, if these particular hotkeys clash with another device or program, then your administrator may change them to a different combination. If the combination fails to work, then please contact the system administrator for details.

Note: VNC hotkeys are set separately to the hotkeys used by the locally connected keyboard. For details about changing the VNC Viewer hotkeys, see [Appendix 2: Unit Configuration](#).

- 2 While still holding and , press the first numeral of the required port address, then:
 - If the port address is a single character, release all of the keys.
 - If the port address is two or more characters, release the first numeral key and press the second – repeat this procedure until all of the port address numerals have been entered, then release and .

Note: The numbers on your keyboard's numeric keypad are not valid, use only the numeral keys above the QWERTY section.

Note: If you do not have authorisation to view the selected port then a message will be displayed to explain your lack of access rights.

Note: When using hotkeys, the leading zeros for all single digit port numbers (including all cascade levels) are optional, i.e. 01, 02...09.

Standard hotkeys

The range of hotkey combinations are as follows:

Note: If your hotkeys have been changed, substitute them for and in the examples given here.

1

Selects port 1

2

Selects port 2

•

•

•

•

1 then

Selects port 10

Note: When entering multiple digit addresses as above, keep and pressed down until all other numbers have been entered.

0

Selects no host

M

Displays the Host Selection menu so that you may choose a host by name.

If you need to enter a port number

Usually, when you make a network connection to the ServSwitch CX Quad IP (either using the VNC viewer or a Web browser) you simply enter the IP address, i.e. 192.168.0.3. However, if a special configuration is necessary, then you may be asked to specify a port number as well as the IP address.

[What is a port?](#)

To enter a port number in a Web browser

- 1 Enter the required IP address in the usual Address box, i.e. http://192.168.0.3
- 2 At the end of the IP address, add a single colon (;) and then enter the port number (in this example, the required port number is 8000), i.e. http://192.168.0.3:8000
- 3 Continue with the standard [Web browser instructions](#).

To enter a port number in VNC viewer

- 1 Enter the required IP address in the usual 'Server' box, i.e. http://192.168.0.3
- 2 At the end of the IP address, add two colons (::) and then enter the port number (in this example, the required port number is 8000), i.e. http://192.168.0.3::8000
- 3 Continue with the standard [VNC viewer instructions](#).

Viewer encryption settings

The web browser viewers and VNC viewers (of level 4.0b5S or higher) offer four encryption options. The resulting actions of certain options depend upon how the ServSwitch CX Quad IP to which you are connecting is configured:

- **Always on** - This setting will ensure that the link is encrypted, regardless of the ServSwitch CX Quad IP encryption setting.
- **Let server choose** - This setting will follow the configuration of the ServSwitch CX Quad IP. If the ServSwitch CX Quad IP has a preference to encrypt the link, then it will be so, otherwise the link will not be encrypted.
- **Prefer off** - This setting will configure an un-encrypted link if the ServSwitch CX Quad IP will allow it, otherwise it will be encrypted.
- **Prefer on** - If the ServSwitch CX Quad IP allows it, this setting will configure an encrypted link, otherwise it will be un-encrypted.

Whenever encryption does take place, the viewer will first need to create the necessary secure key before the connection process can continue.

Supported web browsers

The following web browsers have been tested and found to work correctly with ServSwitch CX Quad IP.

Windows

- Internet Explorer 5.50 and above,
with Microsoft [Java] Virtual Machine (release 5.50).
with Java Runtime Environment 1.3 or above.

Linux

- Netscape 4.61 and above,
with Java Runtime Environment 1.1 or above.
- Opera,
with Java Runtime Environment 1.1 or above.



Further information



This chapter contains a variety of information, including the following:

- Getting assistance - see below
- Troubleshooting - see right
- Appendices
 - Appendix 1 - [Configuration menus](#)
 - Appendix 2 - [Configuration pages via viewer](#)
 - Appendix 3 - [VNC viewer connection options](#)
 - Appendix 4 - [VNC viewer window options](#)
 - Appendix 5 - [Browser viewer options](#)
 - Appendix 6 - [Addresses, masks and ports](#)
 - Appendix 7 - [Cascading multiple units](#)
 - Appendix 8 - [Cable specifications](#)
 - Appendix 9 - [Hotkey sequence codes](#)
 - Appendix 10 - [Supported video modes](#)
- [Safety information](#)
- [End user licence agreement](#)
- [Radio frequency energy statements](#)

Getting assistance

If you are still experiencing problems after checking the list of solutions in the Troubleshooting section then we provide a number of other solutions:

- Email in the US: techsupport@blackbox.com
in the UK: techhelp@blackbox.co.uk
- Phone in the US: **724-746-5500**
in the UK: **+44 (0)118 965 6000**

[Other subsidiaries](#)

Troubleshooting

Global network users are unable to contact the ServSwitch CX Quad IP

- Check that the correct address is being used by the remote users.
- Check the [network settings](#). Check that the users network address has not been excluded in the [IP access control section](#).
- If the ServSwitch CX Quad IP is situated behind a firewall, check that the relevant ports are being allowed [through the firewall](#) and are being correctly routed.
- Check the [front panel indicators](#), the LNK indicator should be on. If the network link is a 100Mbps connection, the 100 indicator should also be on.

The remote cursor is not correctly responding to my mouse movements

- [Recalibrate the mouse](#). When doing so, ensure that the host system does not have mouse cursor trails enabled and that the top left corner of the screen is clear of application windows.

When logging on using VNC viewer, I cannot enter a username

- Either, the VNC viewer is an old version ([download a new one](#)) or only the admin user has been configured on the ServSwitch CX Quad IP.

INSTALLATION

CONFIGURATION

OPERATION

FURTHER INFORMATION

INDEX

Appendix 1 – Local setup menus

The ServSwitch CX Quad IP local setup menus allow a range of settings to be made both to the installation as a whole and to parts of the system accessed by each user.

To access the local setup menus

- 1 On the locally connected keyboard/mouse, select the Select Host screen in one of two ways:
 - By simultaneously pressing and then releasing **Ctrl**, **Alt**, **M**, or
 - By pressing the middle and right buttons of a three button mouse.

If you are not already logged in, do so now. [What to do if the ADMIN password has been forgotten.](#)

- 2 Press **F1** to display the Main Menu.

- 3 Use the following keys:

↑ and **↓** to highlight required options.

Space or arrow buttons to change values.

Esc to quit and save the changes.

The full set of options are only available to the Admin user. All other users will see only the Functions and User Preferences options.

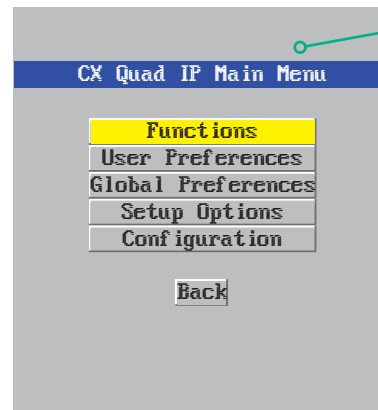

The following items and menus are available in the Main Menu screen:

- [Functions](#)
- [User Preferences](#)
- [Global Preferences](#)
- [Setup Options](#)
- [Configuration](#)



Functions

The Functions menu contains a collection of procedures that affect various aspects of ServSwitch CX Quad IP operation.

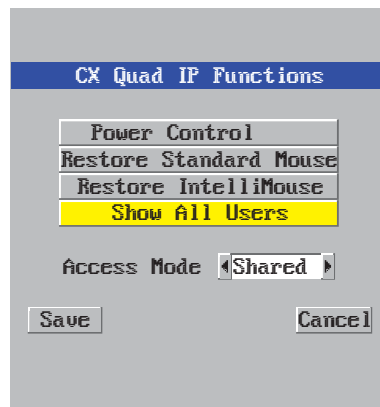

To get here

- 1 From a local keyboard, log on as a standard or 'admin' user.
- 2 Press **Ctrl** **Alt** **M** (hotkeys can change).
- 3 Press **F1** to show the Main Menu.
- 4 Select 'Functions' and press **↓**.

Power Control

The options within this section are usable only when the ServSwitch CX Quad IP is used in conjunction with one or more external power switch units and when valid power switching strings have been registered for the currently selected host. For more details see: power switching [connections](#), [configuration](#) or [operation \(via menu\)](#)

Switch Computer ON

Select this option to power on one or more computers.

Switch Computer OFF

Select this option to power off one or more computers.

Restore Standard Mouse

This option is used to resume standard mouse operation if it has ceased to operate, for instance, if it has been connected without rebooting the ServSwitch CX Quad IP.

Restore Intellimouse

This option is used to resume Microsoft Intellimouse operation if it has ceased to operate, for instance, if it has been connected without rebooting the ServSwitch CX Quad IP.

Show All Users

This option displays a list of all users who are currently logged into the ServSwitch CX Quad IP unit together with the host computer (and port) that they are currently viewing.



INSTALLATION

CONFIGURATION

OPERATION

FURTHER INFORMATION

INDEX

User Preferences

The User Preferences are system operating parameters that are independently selectable for each user and affect only their screen.

To get here

- 1 From a local keyboard, log on as a standard or 'admin' user.
- 2 Press **Ctrl** **Alt** **M** (hotkeys can change).
- 3 Press **F1** to show the Main Menu.
- 4 Select 'User Preferences' and press **↓**.

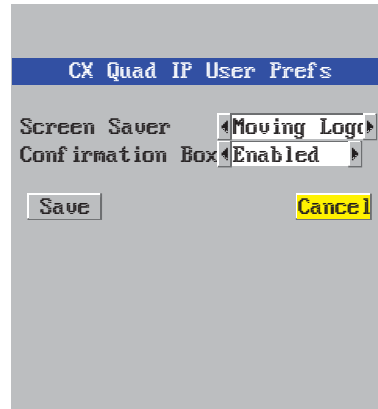

Screen Saver

Settings: *Blank, Moving Logo*

You can select the type of screen saver. If you select BLANK then the screen will blank completely. If you select Moving Logo then a small logo will bounce around the screen.

Confirmation Box

Settings: *Disabled, Enabled*

When enabled, a confirmation box is displayed on screen for three seconds after a computer is selected. The confirmation box indicates the current user port and user name, the selected computer and the connection status.



INSTALLATION

CONFIGURATION

OPERATION

FURTHER
INFORMATION

INDEX

Global Preferences

Global preferences are available only to the Admin user and allow settings to be made that affect all users attached to the ServSwitch CX Quad IP.

To get here

- 1 From a local keyboard, log on as the 'admin' user.
- 2 Press **Ctrl** **Alt** **M** (hotkeys can change).
- 3 Press **F1** to show the Main Menu.
- 4 Select 'Global Preferences' and press .

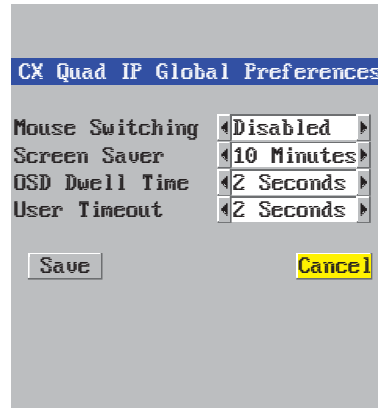

Mouse Switching

Settings: Enabled, Disabled

The computer channel can be switched using a three button mouse or IntelliMouse. Pressing the central button or wheel button together with the left hand mouse button will cause the ServSwitch CX Quad IP to switch to the next available computer.

When mouse switching is enabled, you can still use the middle button on its own to control applications. Only when its pressed with the left or right button is it interpreted by mouse switching, otherwise it is passed on to the host application. The rotation action of an IntelliMouse wheel is not affected and is always available to the computer application.

Screen Saver

Settings: Disabled; 2, 5, 10, 15 or 20 Minutes

The ServSwitch CX Quad IP can be set to blank the screen after no keyboard or mouse activity has been detected for a selected timeout period. If preferred, the user can blank the screen manually by selecting channel '0' using the keyboard hotkeys or by pressing ESC from the login screen.

OSD Dwell Time

Settings: 1, 2, 3, 5, 10 Seconds

After a successful computer channel change the ServSwitch CX Quad IP will display a confirmation message for a few seconds. The length of time that this confirmation message dwells on the screen may be changed.

User Timeout

Settings: 1, 2, 5, 10, 30 Seconds, 1, 5, 10 Minutes

When no keyboard or mouse data has been received from an active user port for the user timeout period, the ServSwitch CX Quad IP will relinquish the control of that user port in order to allow other users to access the host computer. The new port then becomes the active port until it too times out. To avoid confusion between users it is desirable to set the timeout period to be sufficiently long so that user's work is not needlessly interrupted by other users and sufficiently short to ensure good overall system efficiency.



Setup Options

Setup options are available only to the Admin user.

To get here

- 1 From a local keyboard, log on as the 'admin' user.
- 2 Press **Ctrl** **Alt** **M** (hotkeys can change).
- 3 Press **F1** to show the Main Menu.
- 4 Select 'Setup Options' and press .

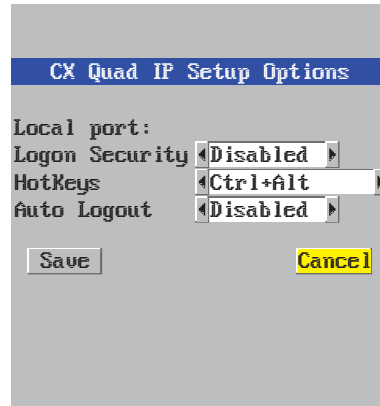

Logon Security

Settings: Disabled, Enabled

With security disabled there is no requirement for users to log-in to the system. All users have full access to all the connected computers and full administration rights. With security enabled, users are required to log-in to the ServSwitch CX Quad IP. Each user is allocated access rights to computers by the system administrator and they are only able to see the computers that they have access to on their on-screen menu.

HotKeys

Settings: Ctrl+Alt, Ctrl+Shift, Alt+Shift, Alt Gr, Left+Right Alt, Left Ctrl+Alt, Right Ctrl+Alt

The keyboard hotkeys are special combinations of keys that, when used together with certain keyboard "command keys", perform special ServSwitch CX Quad IP functions. For example, pressing the hotkeys together with the "M" key will cause the on-screen menu to be displayed on your monitor. Other hotkey combinations allow you to query which computer you are connected to and to move the on-screen menu around the screen. You can also use the hotkeys together with the port number to select a particular connected computer.

Auto Logout

Settings: Disabled, Enabled

The ServSwitch CX Quad IP enables you to restrict access to your computers on a login basis. If a user forgets to logout when they have finished accessing the ServSwitch CX Quad IP then the user console may unintentionally be left with full access to all the computers. The ServSwitch CX Quad IP can be set to automatically logout unattended user consoles when the screen saver kicks in. This reduces the risk of security problems by preventing user consoles remaining in a permanent "logged-in" state when there is no keyboard or mouse activity. The automatic logout feature is only enabled when the screen saver feature is active (i.e. not disabled).



Configuration

Available only to the Admin user, the configuration section menu allows you to determine settings that relate directly to the global (IP) user aspects of the unit.

To get here

- 1 From a local keyboard, log on as the 'admin' user.
- 2 Press **Ctrl** **Alt** **M** (hotkeys can change).
- 3 Press **F1** to show the Main Menu.
- 4 Select 'Configuration' and press .

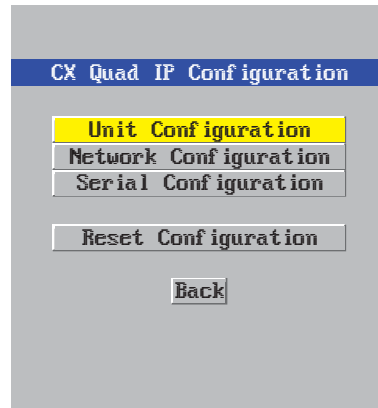

- [Unit Configuration](#)
IP admin password, encryption settings, etc.
- [Network Configuration](#)
IP address, net mask, VNC port, etc.
- [Serial Configuration](#)
Options port usage and Baud rate.
- [Reset Configuration](#)
Completely resets the ServSwitch CX Quad IP unit.



INSTALLATION

CONFIGURATION

OPERATION

FURTHER
INFORMATION

INDEX

Unit Configuration

This page provides access to a selection of both basic and fundamental settings for the ServSwitch CX Quad IP.

To get here

- 1 From a local keyboard, log on as the 'admin' user.
- 2 Press **Ctrl** **Alt** **M** (hotkeys can change).
- 3 Press **F1** to show the Main Menu.
- 4 Select 'Configuration' and press **↓**.
- 5 Select 'Unit Configuration' and press **↓**.

CX Quad IP Unit Config	
Hardware	CXQUADIP 32M+32M
Firmware	1.06.13
Keybd Layout	UK
Admin Passwd	[REDACTED]
Unit Name	CX Quad IP
Time	00:59:52
Date	26 Nov 2009
Encryption	Always On

Save Cancel

Hardware

Indicates the version of the internal circuitry.

Firmware

Indicates the version of the internal software.

Keybd Layout

Use the arrow buttons to match the keyboard layout expected by the host system.

Admin Passwd

Enter the password that will be used to gain administrator access to the ServSwitch CX Quad IP. There can only be one admin user and only that user is given access to the configuration menus. The admin password background will be red until a reasonably secure password has been entered, although this is only advisory as any password or no password may be entered.

Unit Name

The name entered here will be displayed on the local menus and the remote VNC/browser windows.

Time and Date

Use the left and right arrow keys to select the correct time and date. The time entry uses the 24 hour clock notation. The internal real time clock will continue to run for roughly one week without power to the unit, after that it will be lost and require resetting. Use the up and down arrow keys to move between each of the sections within the time and date entries.

Encryption

Three options are available: Always on, prefer off, prefer on. The one to choose depends on the specific details of your installation - see [Encryption settings](#) for details. The use of encryption imposes a slight performance overhead of roughly 10% but is highly secure against third party intrusion.



INSTALLATION

CONFIGURATION

OPERATION

FURTHER INFORMATION

INDEX

Network Configuration

This page allows you to configure the various aspects of the IP port and its relationship with the local network.

To get here

- 1 From a local keyboard, log on as the 'admin' user.
- 2 Press **Ctrl** **Alt** **M** (hotkeys can change).
- 3 Press **F1** to show the Main Menu.
- 4 Select 'Configuration' and press **↓**.
- 5 Select 'Network Configuration' & press **↓**.

CX Quad IP Network Config	
MAC Address	66:CB:23:00:00:22
Use DHCP	◀No▶
IP Address	192.168.1.42
Net Mask	255.255.255.0
Gateway	
VNC Port	5900
HTTP Port	80
Clear IP Access Control	
Save	Cancel

MAC Address

Media Access Control address – this is the unique and unchangeable code that was hard coded within your ServSwitch CX Quad IP unit when it was built. It consists of six 2-digit hexadecimal (base 16) numbers separated by colons. A section of the MAC address identifies the manufacturer, while the remainder is effectively the unique electronic serial number of your particular unit.

Use DHCP

DHCP stands for 'Dynamic Host Configuration Protocol'. Its function is particularly useful when connecting to medium size or larger networks, such as the Internet. When this option is selected, your ServSwitch CX Quad IP will attempt to locate a DHCP server on the network. If such a server is located, it will supply three things to the ServSwitch CX Quad IP: an IP address, an IP network mask (also known as a Subnet mask) and a Gateway address. These are not usually granted permanently, but on a 'lease' basis for a fixed amount of time or for as long as the ServSwitch CX Quad IP remains connected and switched on. [Discover allocations.](#)

IP Address

This is the identity of the ServSwitch CX Quad IP within a network. The IP address can be thought of as the telephone number of the ServSwitch CX Quad IP. Unlike the MAC address, the IP address can be altered to suit the network to which it is connected. It can either be entered manually or configured automatically using the DHCP option. When the DHCP option is enabled, this entry is unavailable. See [IP addresses.](#)

Net Mask

Also often called the 'subnet-mask', this value is used alongside the IP address to help define a smaller collection (or subnet) of devices on a network. In this way a distinction is made between locally connected devices and ones that are reachable elsewhere, such as on the wider Internet. This process helps to reduce overall traffic on the network and hence speed up connections in general. See [Net masks.](#)

Gateway

This is the address of the device that links the local network (to which the ServSwitch CX Quad IP is connected) to another network such as the Internet. Usually this is a network switch or router and it will be used whenever a device to be contacted lies outside the local network.

VNC Port

This is the logical link through which communications with a remote VNC viewer will be channelled (see [What is a port?](#)). The default setting is 5900 which is a widely recognized port number for use by VNC software. However, in certain circumstances it may be advantageous to alter this number - see [Security issues with ports](#) for more details.

Note: The VNC port and HTTP port can be set to the same port number in order to simplify router and firewall configuration. If this is done then the ServSwitch CX Quad IP will "listen" for both types of traffic on the single port.

HTTP Port

This is the logical link through which communications with a remote web browser will be channelled. The default setting of 80 is an established standard for web (HTTP – HyperText Transfer Protocol) traffic though this can be changed to suit your local network requirements.

Clear IP Access Control

This option removes all entries from the IP access control feature within the ServSwitch CX Quad IP. The IP access control feature (configurable by a global admin user) allows certain network address ranges to be denied access to the ServSwitch CX Quad IP. If set incorrectly, it is possible to exclude all network users and so this option provides an emergency recovery point.





Serial Configuration

This page allows you to configure the OPTIONS serial port located at the rear of the ServSwitch CX Quad IP.

To get here

- 1 From a local keyboard, log on as the 'admin' user.
- 2 Press **Ctrl** **Alt** **M** (hotkeys can change).
- 3 Press **F1** to show the Main Menu.
- 4 Select 'Configuration' and press **↓**.
- 5 Select 'Serial Configuration' & press **↓**.

CX Quad IP Serial Config

Options Port **Power Control**

Options Baud **9600**

Save Cancel

Options Port

Settings: Power Control, Sync Units

Determines whether the RS232 serial OPTIONS port at the rear of the unit will be used for connection to power control switches or to synchronize the operation of two ServSwitch CX Quad IP units.

Options Baud

Settings: 1200, 2400, 4800, 9600, 19200, 38400, 57600, 115200

This option determines the speed of the RS232 serial OPTIONS port. The other communication settings are fixed as: No parity, 8 bit word, 1 stop bit.

Note: When 'Options Port' is set to 'Sync Units', the baud rate will be automatically changed to 19200.

INSTALLATION

CONFIGURATION

OPERATION

FURTHER INFORMATION

INDEX



Reset Configuration

This option allows you to completely reset the IP portion of the ServSwitch CX Quad IP unit.

WARNING: This process will remove all network settings and return the unit to use its original state. A complete reconfiguration will be required before the IP features of the unit can be used.

To get here

- 1 From a local keyboard, log on as the 'admin' user.
- 2 Press **Ctrl** **Alt** **M** (hotkeys can change).
- 3 Press **F1** to show the Main Menu.
- 4 Select 'Configuration' and press **↓**.
- 5 Select 'Reset Configuration' and press **↓**.

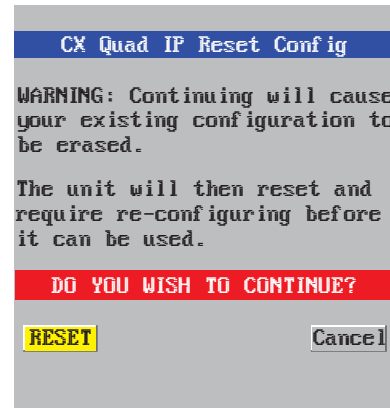

To reset the ServSwitch CX Quad IP configuration

- 1 From a local or remote (not accessible from a global keyboard), log on as the 'admin' user.
- 2 Press **Ctrl** **Alt** **M** (hotkeys can change).
- 3 Press **F1** to select 'More menus'.
- 4 Select 'Configuration'.
- 5 Select 'Reset Configuration'.
- 6 Highlight the 'Reset' option and press **↓**.
- 7 After a short period, you should see the first of five initial configuration screens. See [Initial configuration](#) for details.

Appendix 2 - Configuration pages via viewer

This section covers the configuration pages that are available to global admin users, using either the VNC viewer or the browser methods of access.

To access the remote configuration pages

- 1 Make a [global connection](#) to the ServSwitch CX Quad IP unit and login as the admin user.
- 2 Once logged in, click the Configure button in the top right corner of the window.

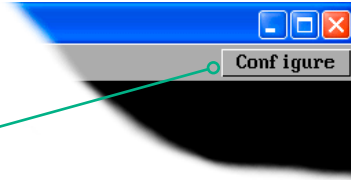

Main configuration page

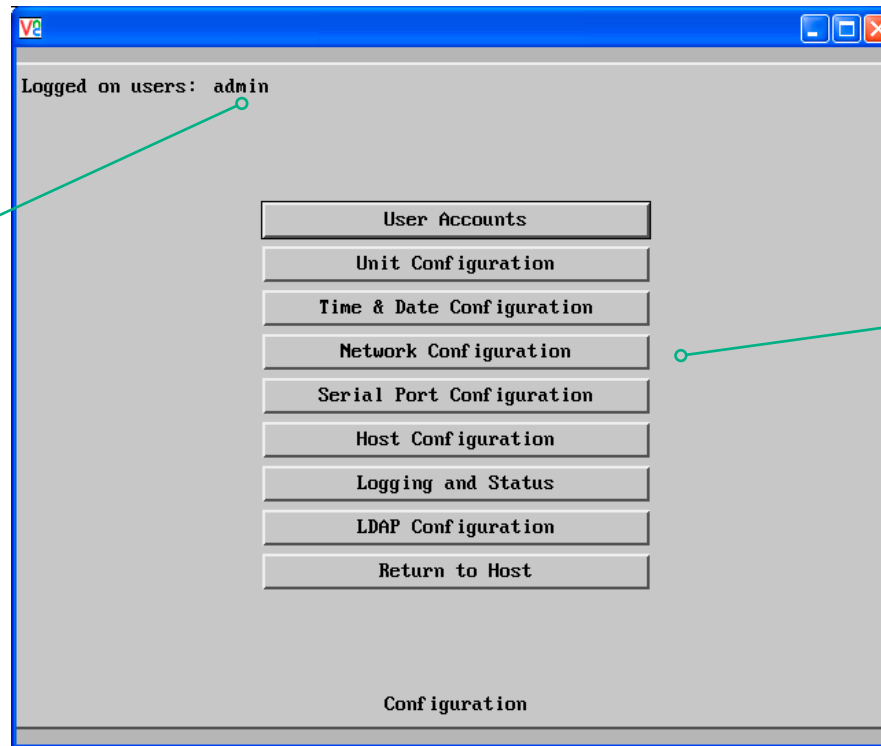

Logged on users

Indicates the current users irrespective of whether they are connected locally or via a network.

Click the required option

- [User Accounts](#)
- [Unit Configuration](#)
- [Time & Date Configuration](#)
- [Network Configuration](#)
- [Serial Port Configuration](#)
- [Host Configuration](#)
- [Logging and Status](#)
- [LDAP Configuration](#)



INSTALLATION

CONFIGURATION

OPERATION

FURTHER INFORMATION

INDEX

User accounts

This page allows you to manage up to sixteen separate accounts.

The first of the sixteen accounts is the admin account and is the only account with access rights to the configuration menus. The user name and access rights are fixed for the admin account, the only change possible for this account is the password.

There are fifteen user account positions.

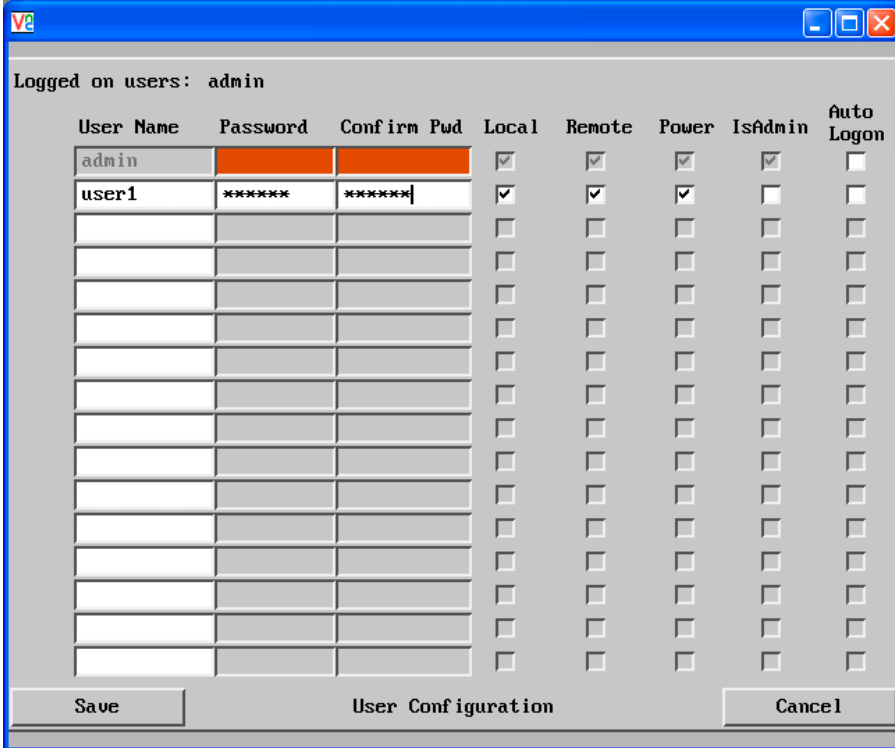

The screenshot shows a 'User Configuration' dialog box with a table of user accounts. The table has columns for User Name, Password, Confirm Pwd, Local, Remote, Power, IsAdmin, and Auto Logon. The 'admin' user is pre-filled with a password and has all access rights checked. The 'user1' user has a password and has Local, Remote, and Power access rights checked. There are 15 rows in total, with the first two filled and the rest empty.

User Name	Password	Confirm Pwd	Local	Remote	Power	IsAdmin	Auto Logon
admin			<input checked="" type="checkbox"/>	<input checked="" type="checkbox"/>	<input checked="" type="checkbox"/>	<input checked="" type="checkbox"/>	<input type="checkbox"/>
user1	*****	*****	<input checked="" type="checkbox"/>	<input checked="" type="checkbox"/>	<input checked="" type="checkbox"/>	<input type="checkbox"/>	<input type="checkbox"/>
			<input type="checkbox"/>	<input type="checkbox"/>	<input type="checkbox"/>	<input type="checkbox"/>	<input type="checkbox"/>
			<input type="checkbox"/>	<input type="checkbox"/>	<input type="checkbox"/>	<input type="checkbox"/>	<input type="checkbox"/>
			<input type="checkbox"/>	<input type="checkbox"/>	<input type="checkbox"/>	<input type="checkbox"/>	<input type="checkbox"/>
			<input type="checkbox"/>	<input type="checkbox"/>	<input type="checkbox"/>	<input type="checkbox"/>	<input type="checkbox"/>
			<input type="checkbox"/>	<input type="checkbox"/>	<input type="checkbox"/>	<input type="checkbox"/>	<input type="checkbox"/>
			<input type="checkbox"/>	<input type="checkbox"/>	<input type="checkbox"/>	<input type="checkbox"/>	<input type="checkbox"/>
			<input type="checkbox"/>	<input type="checkbox"/>	<input type="checkbox"/>	<input type="checkbox"/>	<input type="checkbox"/>
			<input type="checkbox"/>	<input type="checkbox"/>	<input type="checkbox"/>	<input type="checkbox"/>	<input type="checkbox"/>
			<input type="checkbox"/>	<input type="checkbox"/>	<input type="checkbox"/>	<input type="checkbox"/>	<input type="checkbox"/>
			<input type="checkbox"/>	<input type="checkbox"/>	<input type="checkbox"/>	<input type="checkbox"/>	<input type="checkbox"/>
			<input type="checkbox"/>	<input type="checkbox"/>	<input type="checkbox"/>	<input type="checkbox"/>	<input type="checkbox"/>
			<input type="checkbox"/>	<input type="checkbox"/>	<input type="checkbox"/>	<input type="checkbox"/>	<input type="checkbox"/>
			<input type="checkbox"/>	<input type="checkbox"/>	<input type="checkbox"/>	<input type="checkbox"/>	<input type="checkbox"/>

To create a new user account

- 1 Enter the required User Name to activate that position (the Password and access tick box positions will become editable).
- 2 Optionally enter a password for the user account.
- 3 Tick/untick the Local, Remote and Power options that are appropriate to the user.
- 4 Click the Save button to register your changes.

To get here

- 1 Using VNC viewer or a browser, log on as the 'admin' user.
- 2 Click the 'Configure' button in the top right corner.
- 3 Click the 'User Accounts' option.

User Name

All user names must consist of lower case characters or numbers only. No symbols or upper case characters are permissible. The user name can be between 1 and 16 characters in length.

Password

Passwords are case sensitive and can include certain keyboard symbols. The password can be between 1 and 16 characters in length. It is important to note, however, that the password background remains shaded in amber while the ServSwitch CX Quad IP considers your entered password to be too easy to guess. A suitable password is best constructed using a mixture of more than 6 letters, numbers and punctuation characters.

Confirm Pwd

Re-enter your password here to confirm that it is correct.

Local

When ticked, the selected user can gain access using the local KVM console directly connected to the ServSwitch CX Quad IP unit.

Remote

When ticked, the selected user can gain access via an IP network link, such as a local intranet or the wider Internet (depending on how the ServSwitch CX Quad IP is connected).

Power

When ticked, the selected user will be permitted to control the power input to host systems (requires optional power control switch unit(s) to be fitted).

IsAdmin

When ticked, the selected user will be given access to the administrator level configuration menus and will also have the ability to force a host computer connection to shared if another user has selected a private session.

Auto Logon

When ticked, the selected user will be automatically logged on at the local user port whenever the unit is powered on. Only one user can be set to use auto logon, by default it is the admin user.



Unit configuration

This page provides access to a selection of both basic and advanced settings for the ServSwitch CX Quad IP. Many of the settings displayed here are also accessible through the on-screen menu.

Logged on users: admin

Hardware Version: CXQUADIP 32M+32M

Firmware Version: 1.06.13

Host Keyboard Layout: < UK >

Admin Password: [REDACTED]

Unit Name: [REDACTED]

Menu Bar Toggle Hot Key: < None >

Display Menu Bar for New Connections

Encryption: < Prefer Off >

Number of simultaneous VNC Users: 4

VNC Viewer Hot Key Sequence: < Ctrl+Alt >

Advanced Unit Configuration

Save Unit Configuration Cancel

Hardware Version

Indicates the version of the electronic circuitry within the ServSwitch CX Quad IP unit.

Firmware Version

Indicates the version of the internal software within the ServSwitch CX Quad IP flash memory. This may be updated using the [flash upgrade procedure](#).

Host Keyboard Layout

Use the arrow buttons to match the keyboard layout expected by the host system.

Admin Password

Enter the password that will be used to gain administrator access to the ServSwitch CX Quad IP. There can only be one admin user and only that user is given access to the configuration menus.

To get here

- 1 Using VNC viewer or a browser, log on as the 'admin' user.
- 2 Click the 'Configure' button in the top right corner.
- 3 Click the 'Unit Configuration' option.

Unit Name

The name entered here will be displayed on the local menus and the remote VNC viewer/browser windows.

Menu Bar Toggle Hot Key

Determines the function key that can be used to display/hide the menu bar within the VNC screen.

Encryption

Three options are available: Always on, prefer off, prefer on. The one to choose depends on the specific details of your installation - see [Encryption settings](#) for details. The use of encryption imposes a slight performance overhead of roughly 10% but is highly secure against third party intrusion.

Number of simultaneous VNC Users

Allows you to restrict the number of concurrent VNC sessions. The maximum number (and the default setting) is 4.

VNC Viewer Hot Key Sequence

When using the VNC Viewer, you can use key press combinations to select host computers and also to display the host selection menu. This option allows you to choose which keys should be used to form the hotkeys that will precede a switching command. The default setting is CTRL + ALT, so as an example when you press the CTRL ALT and 2 keys, the viewer will change to the host located at port 2.

[Advanced Unit Configuration](#)



Advanced unit configuration

Click this button to display advanced options that do not normally require alteration.

Logged on users: admin, admin

Force VNC Protocol 3.3

Idle Timeout (minutes) 60

Session Sleep Timeout (minutes) 20

Protocol Timeout (seconds) 20

Background Refresh Rate < Auto >

Mouse Latency Allowance (milliseconds) 0

Mouse Rate (milliseconds) 20

Single Mouse Mode Mouse Switch < Disabled >

Use Quick Mouse Calibration

Behaviour for admin connections when limit reached < Replace oldest connection >

Use VESA GTF

Upgrade Firmware Reset Unit

Save Advanced Unit Configuration Cancel

Force VNC Protocol 3.3

IMPORTANT: The use of this option is not recommended. Protocol 3.3 is a legacy version that does not offer any encryption.

Idle Timeout

Determines the period of inactivity on a global connection before the user is logged out. The idle timeout period can be set to any time span, expressed in minutes.

Note: The [Screensaver](#) option serves a similar purpose for local connections.

Protocol Timeout

Sets the time period by which responses should have been received to outgoing data packets. If the stated period is exceeded, then a connection is considered lost and terminated.

Session Sleep Timeout

Determines the period of inactivity before the viewer screen will blank and a message is displayed. When no hosts are being viewed either because of this time out or if no viewers are active then parts of the video circuitry are powered down reducing power consumption by up to a third.

Background Refresh Rate

Use the arrow keys to alter the refresh rate for screen images via remote links. This allows you to tailor the screen refresh to suit the network or modem connection speeds. The options are: Slow, Medium, Fast or Disabled. When the disabled option is selected, the remote users will need to manually refresh the screen.

Note: When a low connection speed is detected, the background refresh is automatically disabled, regardless of the settings of this option.

Mouse Latency Allowance

This option is used during calibration to account for latency delays that may be caused as signals pass through a device.

During calibration, the ServSwitch CX Quad IP waits for 40ms after each mouse movement before sampling the next. If a device adds a significant delay to the flow of data, the calibration process can be lengthened or may fail entirely. The value entered here is added to (or subtracted from) the default 40ms sampling time.

Note: You can enter negative values (down to -40) in order to speed up the calibration process when using fast KVM switches. Use this option with caution as it can adversely affect the calibration process.

Mouse Rate

Defines the rate at which mouse movement data are transmitted to the system. The default option is 20ms, which equates to 50 mouse events per second. This is used to slow down the rate in exceptional circumstances but normally requires no adjustment.

Single Mouse Mode Mouse Switch

Select the mouse button combination to exit from single mouse mode (when active).

Use Quick Mouse Calibration

Invokes optimized calibration techniques that handle the majority of mouse types.

Behaviour for admin connections when limit reached

Determines what should occur when four global connections already exist and a fifth, administrator connection attempt is made. Options are: *Replace oldest connection*, *Replace newest connection* and *Don't replace*. Only non-administrator connections can be terminated in this way.

Use VESA GTF

When ticked, the VESA Generalized Timing Formula will be used to help determine the correct input video resolution and timing details. See [Appendix 10](#) for a list of all supported video modes.

Upgrade firmware

Places the unit into upgrade mode. See [Upgrading ServSwitch CX Quad IP models](#).



Time & date configuration

This page allows you to configure all aspects relating to time and date within the ServSwitch CX Quad IP unit.

Logged on users: admin

Time And Date

Timezone specifier (e.g. EST5)

Use NTP

NTP Server IP address

Set Time from NTP Server

Save Time & Date Configuration Cancel

Time and Date

Use the arrow buttons to set the correct current time.

Use NTP

When this option is selected, the ServSwitch CX Quad IP will synchronize its internal clocks using information from the (Network Time Protocol) server listed in the *NTP Server IP address* field.

NTP Server IP address

Optionally enter the IP address for a known Network Time Protocol server.

Set Time from NTP Server

Click to immediately use the time and date information from the listed NTP server.

Timezone specifier

Optionally enter a recognized timezone specifier related to the current position of the ServSwitch CX Quad IP unit. When an NTP server is used, the specifier will be used to provide the correct real time.

The timezone specifier takes the following form:

std offset dst [offset], start[/ time], end[/ time]

The *std* and *offset* specify the standard time zone, such as GMT and 0, or CET and -1, or EST and 5, respectively.

The *dst* string and *[offset]* specify the name and offset for the corresponding Daylight Saving Time zone; if the *offset* is omitted, it defaults to one hour ahead of standard time.

The remainder of the specification describes when Daylight Saving Time is in effect. The *start* field is when Daylight Saving Time goes into effect and the *end* field is when the change is made back to standard time. The most common format used for the daylight saving time is: *mm.w.d*

Where: *m* specifies the month and must be between 1 and 12. The day *d* must be between 0 (Sunday) and 6. The week *w* must be between 1 and 5; week 1 is the first week in which day *d* occurs, and week 5 specifies the last *d* day in the month.

The *time* fields specify when, in the local time currently in effect, the change to the other time occurs. If omitted, the default is 02:00:00.

Typical examples are:

UK:	GMT0BST,M3.5.0/1,M10.5.0/2
Central Europe:	CET-1CEST,M3.5.0/2,M10.5.0/3
US Eastern:	EST5EDT,M3.2.0/2,M11.1.0/2
US Pacific:	PST5PDT,M3.2.0/2,M11.1.0/2

For further details

- For details of timezone specifier formats, please refer to: http://www.gnu.org/software/libc/manual/html_node/TZ-Variable.html
- For details of the Network Time Protocol (main RFC number: 1305; the SNTP subset used as the basis for the ServSwitch CX Quad IP: 4330) <http://www.ietf.org/rfc.html>



INSTALLATION

CONFIGURATION

OPERATION

FURTHER INFORMATION

INDEX

Network configuration

This page allows you to configure the various aspects of the IP port and its relationship with the local network.

The screenshot shows a 'Network Configuration' window with the following fields and values:

- Logged on users: admin
- MAC address: 00:1E:ED:00:40:07
- Use DHCP:
- IP Address: 192.168.0.10
- IP Network Mask: 255.255.255.0
- IP Gateway: (empty)
- UNC Port: 5900
- HTTP Port (0=disabled): 80
- IP Access Control: +0.0.0.0/0.0.0.0

Buttons at the bottom: Save, Network Configuration, Cancel.

MAC address

Media Access Control address – this is the unique and unchangeable code that was hard coded within your ServSwitch CX Quad IP unit when it was built. It consists of six 2-digit hexadecimal (base 16) numbers separated by colons. A section of the MAC address identifies the manufacturer, while the remainder is effectively the unique electronic serial number of your particular unit.

Use DHCP

DHCP is an acronym for 'Dynamic Host Configuration Protocol'. Its function is particularly useful when connecting to medium size or larger networks, such as the Internet. When this option is selected, your ServSwitch CX Quad IP will attempt to locate a DHCP server on the network. If such a server is located, it will supply three things to the ServSwitch CX Quad IP: an IP address, an IP network mask (also known as a Subnet mask) and a Gateway address. These are not usually granted permanently, but on a 'lease' basis for a fixed amount of time or for as long as the ServSwitch CX Quad IP remains connected and switched on. [Discover allocations.](#)

To get here

- 1 Using VNC viewer or a browser, log on as the 'admin' user.
- 2 Click the 'Configure' button in the top right corner.
- 3 Click the 'Network Configuration' option.

IP Address

This is the identity of the ServSwitch CX Quad IP within a network. The [IP address](#) can be thought of as the telephone number of the ServSwitch CX Quad IP. Unlike the MAC address, the IP address can be altered to suit the network to which it is connected. It can either be entered manually or configured automatically using the DHCP option. When the DHCP option is enabled, this entry is greyed out.

IP Network Mask

Also often called the [subnet-mask](#), this value is used alongside the IP address to help define a smaller collection (or subnet) of devices on a network. In this way a distinction is made between locally connected devices and ones that are reachable elsewhere, such as on the wider Internet. This process helps to reduce overall traffic on the network and hence speed up connections in general.

IP Gateway

This is the address of the device that links the local network (to which the ServSwitch CX Quad IP is connected) to another network such as the wider Internet. Usually the actual gateway is a network switch or router and it will be used whenever a required address lies outside the current network.

VNC Port

This is the logical link through which communications with a remote VNC viewer will be channelled (see [What is a port?](#)). The default setting is 5900 which is a widely recognized port number for use by VNC software. However, in certain circumstances it may be advantageous to alter this number - see 'Security issues with ports' for more details.

HTTP Port

This is the logical link through which communications with a remote web browser will be channelled (see [What is a port?](#)). The default setting of 80 is an established standard for web (HTTP – HyperText Transfer Protocol) traffic though this can be changed to suit your local network requirements.

IP Access Control

This section allows you to optionally specify ranges of addresses which will or won't be granted access to the ServSwitch CX Quad IP. If this option is left unchanged, then the default entry of '+0.0.0.0/0.0.0.0' ensures that access from all IP addresses will be permitted. See [Setting IP access control](#) for details.





Setting IP access control

The golden rule with this feature is 'Include before you exclude' or to put it another way 'Arrange *allowed* addresses in the list *before* the *denied* addresses'.

This is because the positions of entries in the list are vitally important. Once a range of addresses is denied access, it is not possible to make exceptions for particular addresses within that range. For instance, if the range of addresses from A to F are denied access first, then the address C could not be granted access lower down the list. Address C needs to be placed in the list before the denied range.

IMPORTANT: This feature should be configured with extreme caution as it is possible to deny access to everyone. If such an error occurs, see [Clearing IP access control](#) for details about how to regain access.

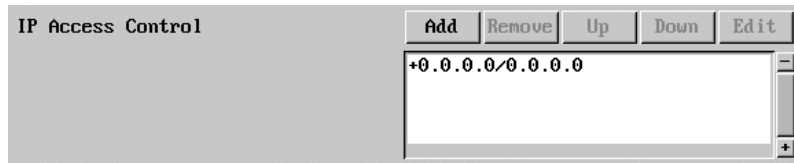

In the list, access control addresses prefixed by '+' are allow entries while those prefixed by '-' are deny entries.

To get here

- 1 Using VNC viewer or a browser, log on as the 'admin' user.
- 2 Click the 'Configure' button in the top right corner.
- 3 Click the 'Network Configuration' option.

To define a new IP access control entry

- 1 Click the Add button to display a popup dialog:

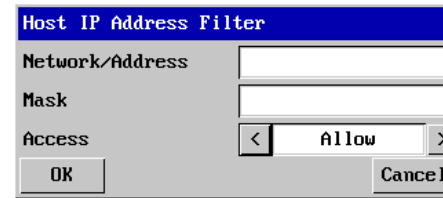

Network/Address

Enter the network address that is to be allowed or denied access. If a range of addresses is being specified then specify any one of the addresses within the range and use the Mask entry to indicate the size of the range.

Mask

Enter an IP network mask that indicates the range of addresses that are to be allowed or denied access. For instance, if only a single specified IP address were to be required, the mask entry would be 255.255.255.255 in order to specify a single location. See [Calculating the mask for IP access control](#) for details.

Access

Use the arrow buttons to select either 'Allow' or 'Deny' as appropriate.

- 2 Enter the base [network address](#), the [mask](#) and select the appropriate access setting.
- 3 Click the OK button.

To reorder access control entries

IMPORTANT: When reordering, ensure that any specific allowed addresses are listed higher in the list than any denied addresses. Take care not to invoke any deny access settings that would exclude valid users.

- 1 In the access control list, click on the entry to be moved.
- 2 Click the Up or Down buttons as appropriate.

To edit/remove access control entries

- 1 In the access control list, click on the appropriate entry.
- 2 Click either the Edit or Remove button as appropriate.

Serial port configuration

This page provides all access to settings concerned with the two serial ports (modem and power control) that are situated at the rear of the ServSwitch CX Quad IP unit.

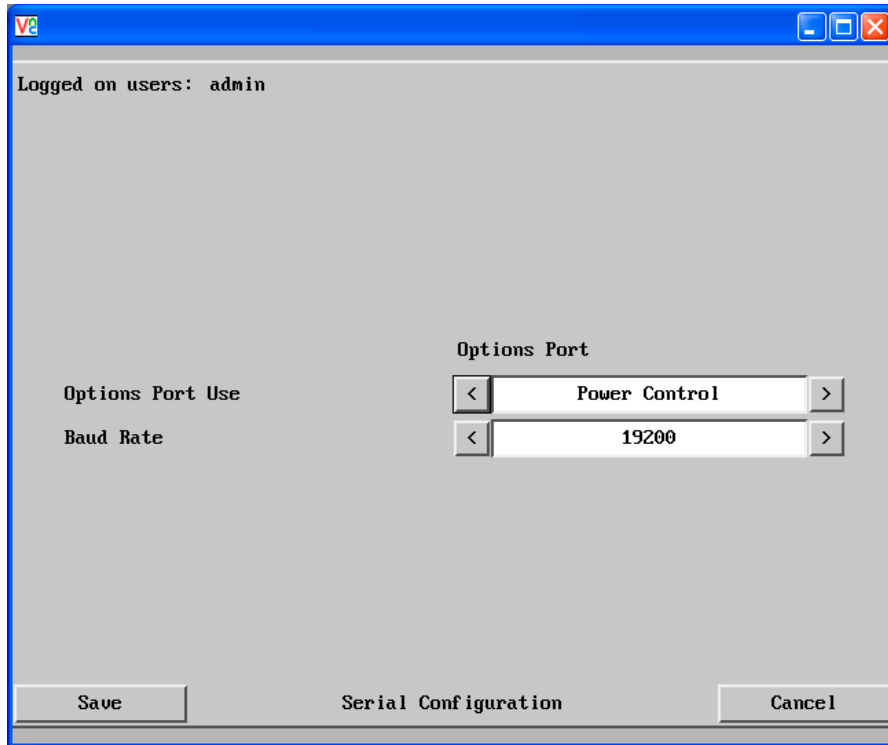

The screenshot shows a web-based configuration window titled "Serial Configuration". At the top left, it says "Logged on users: admin". The main area contains two settings:

- Options Port Use:** A dropdown menu currently set to "Power Control".
- Baud Rate:** A text input field containing the value "19200".

At the bottom of the window, there are three buttons: "Save", "Serial Configuration" (the window title), and "Cancel".

To get here

- 1 Using VNC viewer or a browser, log on as the 'admin' user.
- 2 Click the 'Configure' button in the top right corner.
- 3 Click the 'Serial Port Configuration' option.

Options Port Use

This option determines whether the RS232 serial OPTIONS port at the rear of the unit will be used for connection to power control switches or to synchronize the operation of two ServSwitch CX Quad IP units.

Baud Rate

This option determines the speed of the RS232 serial OPTIONS port. The other communication settings are fixed as: No parity, 8 bit word, 1 stop bit.



INSTALLATION

CONFIGURATION

OPERATION

FURTHER
INFORMATION

INDEX

Host configuration

This page provides the opportunity to configure various details for each of the host systems that may be connected to the ServSwitch CX Quad IP. Each entry can be configured with a name, the permitted users, the hot key combinations required to switch to it and, if required, appropriate power control commands.

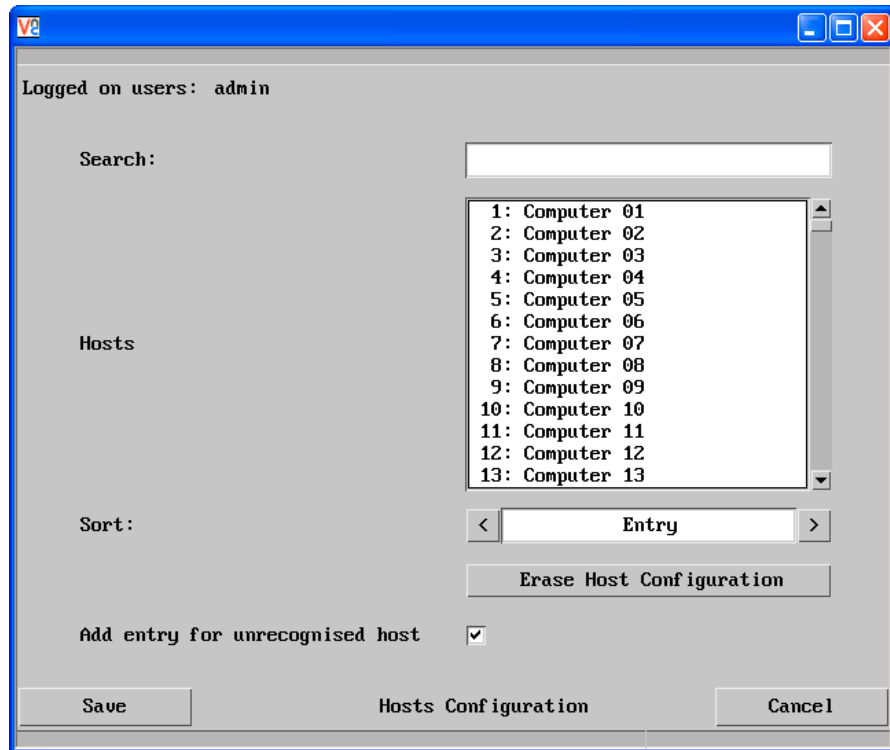

Add entry for unrecognized host

When selected, any systems visited that are not specified in the Hosts list, will be added to the list. It is useful to tick this option when cascaded systems are first added to the installation.

Sort

Allows you to reorder the list of hosts either alphabetically or by entry number.

Erase Host Configuration

Removes all hosts from the list.

To get here

- 1 Using VNC viewer or a browser, log on as the 'admin' user.
- 2 Click the 'Configure' button in the top right corner.
- 3 Click the 'Host Configuration' option.

To create a new host entry

- 1 Click one of the host entries to reveal a Host configuration dialog.

Note: Host computers connected to a cascaded ServSwitch unit will appear within the list (providing the 'Add entry for unrecognized host' option is ticked) and you can easily discern them from directly connected systems because their addresses will be four digits, rather than two.

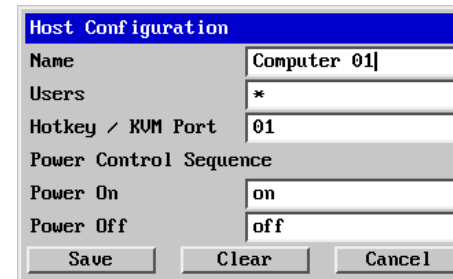

Name

Enter the name that will be displayed in the viewer window when you click the Host button.

Users

Select the users that will be permitted to connect to this host. Either enter * to allow all users or a list of users separated by commas (e.g. admin, nigel, preben, steve).

Hotkey / KVM Port

Declare the numeric sequence that is pressed together with the hotkeys (usually Ctrl + Alt) to select this host system, which is the same value as the KVM port number.

Power On

Enter the code required to make an attached power control unit apply power to the selected host. See [Power switching configuration](#) for details.

Power Off

Enter the code required to make an attached power control unit remove power from the selected host. See [Power switching configuration](#) for details.

- 2 Enter the required information in each field.
- 3 Click the OK button.



Logging and status

This screen provides various details about the user activity on the ServSwitch CX Quad IP unit.

Date and time the event occurred

Type of event, user name and access method or remote IP address

```
Logged on users: admin
```

```
Jan 1 23:23:49 arkapp: Logoff admin, local
Jan 1 23:23:50 arkapp: Logon admin, local, autologon
Jan 1 23:23:57 arkapp: Logoff admin, local
Jan 1 23:23:58 arkapp: Logon admin, local, autologon
Jan 1 23:24:32 arkapp: Logoff admin, local
Jan 1 23:24:40 arkapp: Logon steve, local, password
Jan 1 23:27:48 arkapp: Switch to host Computer 01
Jan 1 23:36:50 arkapp: disconnected: 192.168.0.2::2131 (Idle timeout)
Jan 1 23:36:50 arkapp: Logoff admin, 192.168.0.2
Jan 1 23:37:37 arkapp: Logoff steve, local
Jan 1 23:37:43 arkapp: Logon admin, local, no auth
Jan 2 00:21:39 arkapp: connected: 192.168.0.2::2286
Jan 2 00:21:43 arkapp: Logon admin, 192.168.0.2, no auth
Jan 2 00:21:43 arkapp: authenticated: 192.168.0.2::2286, as admin (Default access)
```

Clear Log **Refresh**

Syslog Server IP Address

Save **Logging and Status** **Cancel**

Click to clear all log entries

Click to refresh the list

Optionally enter an IP address to which the status log should be sent

Click to return to the main menu

To copy and paste the log

You can copy the information listed within the log and paste it into another application.

- 1 While viewing the log screen, press Ctrl and C, to copy the data into the clipboard.
- 2 In a text application (i.e. Word, WordPad, Notepad) press Ctrl and V, or right mouse click and 'Paste'.

Syslog Server IP Address

Logging information can optionally be sent, as it occurs, to a separate system using the standard Syslog protocol. Enter the IP address of a suitable system in the field provided.

For further details

- For details of the Syslog protocol (RFC number: 3164) <http://www.ietf.org/rfc.html>

To get here

- 1 Using VNC viewer or a browser, log on as the 'admin' user.
- 2 Click the 'Configure' button in the top right corner.
- 3 Click the 'Logging and Status' option.



LDAP configuration

The ServSwitch CX Quad IP can optionally use the industry standard LDAP (Lightweight Directory Access Protocol) to allow user authentication to occur in conjunction with an externally held database. This screen allows you to configure details related to the creation of an LDAP link to an external directory service, such as an Active Directory server.

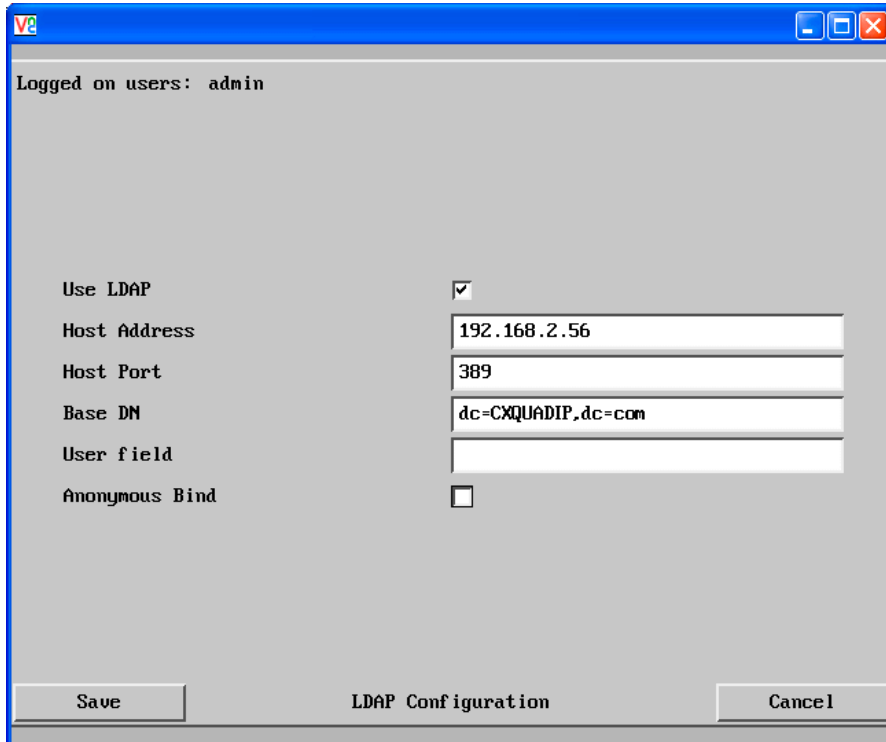

Logged on users: admin

Use LDAP

Host Address

Host Port

Base DN

User field

Anonymous Bind

Save LDAP Configuration Cancel

To get here

- 1 Using VNC viewer or a browser, log on as the 'admin' user.
- 2 Click the 'Configure' button in the top right corner.
- 3 Click the 'LDAP Configuration' option.

Use LDAP

Tick this option to enable the Lightweight Directory Access Protocol features of the unit.

Host Address

Enter the IP address of the LDAP server that holds the required directory service.

Host Port

The standard port address for LDAP links is 389 and this should not need to be changed unless special circumstances exist.

Base DN

This field allows you to enter a Distinguished Name for the unit which will be used as the main identifier during (non-anonymous bind) LDAP sessions. An example Base DN value might be: "dc=CXQUADIP,dc=com"

User field

Enter the LDAP database field that will be used to match each user name against. The details entered here will depend on the specific LDAP database being used - 'uid' or 'cn' are commonly used values.

Anonymous Bind

If left unchecked then bind requests are sent with username (Base DN) and password (more suitable for Active Directory applications).

If checked, bind requests are anonymous (more suitable for Linux LDAP implementations).



Appendix 3 - VNC viewer connection options

When you are connecting to the ServSwitch CX Quad IP using the VNC viewer, a number of options are available.

Click here to access the options

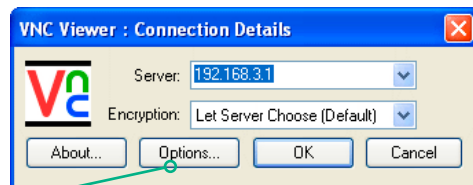

There are six tabbed pages of options:

- Colour/Encoding
- [Inputs](#)
- [Scaling](#)
- [Misc](#)
- [Identities](#)
- [Load/Save](#)

IMPORTANT: If you make any changes to the options given here and wish to retain them for successive connection sessions, you must save the changes. To do this, change to the 'Load/Save' tab and click the 'Save' button within the 'Default' section.

Colour/Encoding

Auto select

When ticked, this option will examine the speed of your connection to the ServSwitch CX Quad IP and apply the most suitable encoding method. This option is suggested for the majority of installations.

Preferred encoding

There are three manually selectable encoding methods which are accessible when the Auto select option is unticked.

- **ZRLE** – This is a highly compressed method that is best suited to slow modem connections.
- **Hextile** – This method offers better performance than the ZRLE when used over a high speed network because there is no need for the ServSwitch CX Quad IP to spend time highly compressing the data.
- **Raw** – This is a primitive, uncompressed method that is mainly used for technical support issues. You are recommended not to use this method.

Colour level

This section allows you to select the most appropriate colour level for the speed of the connection to the ServSwitch CX Quad IP. Where the connection speed is slow or inconsistent there will be a necessary compromise between screen response and colour depth.

- **Full** – This mode is suitable only for fast network connections and will pass on the maximum colour depth being used by the host system.
- **Medium (256 colours)** – This mode reduces the host system output to a 256 colour mode and is more suitable for ISDN and fast modem connections.
- **Low (64 colours)** – This mode is suitable for slower modem connections and reduces the host system output to 64 colours.
- **Very low (8 colours)** – This mode provides very rudimentary picture quality and hardly any speed advantage over the 64 colour setting. You are recommended not to use this mode.

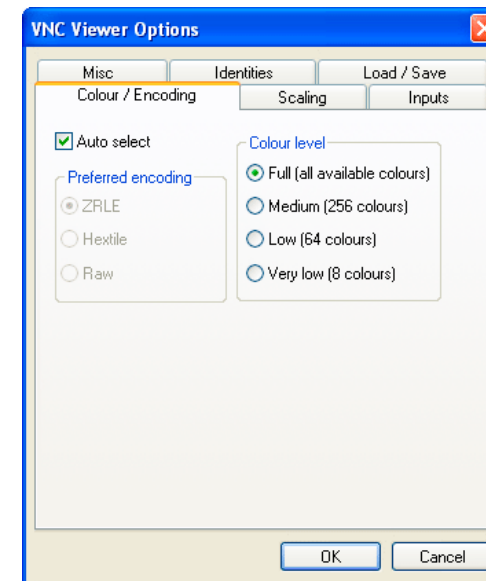

Inputs

Enable all inputs

When selected, allows keyboard, mouse and clipboard data to be transferred between server and viewer systems.

Disable all inputs (view-only mode)

When selected, prevents control data being passed between server and viewer. Viewer can display the server output, but cannot control it.

Customise

Allows you to select which data can be transferred between server and viewer.

Send pointer events to server

When un-ticked, the VNC viewer will not send mouse movement or click data to the ServSwitch CX Quad IP or host system.

Send keyboard events to server

When un-ticked, the VNC viewer will not send keyboard information to the ServSwitch CX Quad IP or host system.

Send clipboard changes to server

This feature is restricted to software server versions of VNC and has no effect on ServSwitch CX Quad IP installations.

Accept clipboard changes from server

This feature is restricted to software server versions of VNC and has no effect on ServSwitch CX Quad IP installations, except for retrieving the activity log as described in the logging and status section.

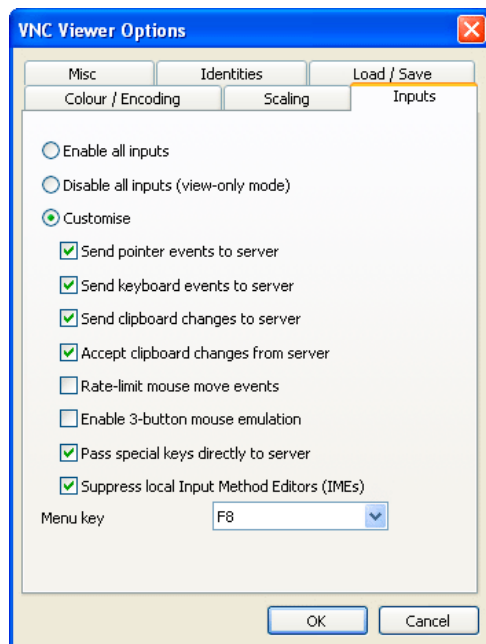

Rate-limit mouse move events

When ticked, this feature reduces the mouse movement information that is sent to the ServSwitch CX Quad IP and host system. This is useful for slow connections and you will notice that the remote cursor will catch up with the local cursor roughly once every second.

Enable 3-button mouse emulation

This feature allows you to use a 2-button mouse to emulate the middle button of a 3-button mouse. When enabled, press the left and right mouse buttons simultaneously to create a middle button action. You are advised to generally use a 3-button mouse.

Pass special keys directly to server

When ticked, 'special' keys (the Windows key, the Print Screen key, Alt+Tab, Alt+Escape and Ctrl+Escape) are passed directly to the ServSwitch CX Quad IP rather than being interpreted locally.

Menu key

This feature allows you to select which function key is used to display the VNC viewer options menu. The menu key is only way to exit from the full screen viewer mode.

IMPORTANT: If you make any changes to the options given here and wish to retain them for successive connection sessions, you must save the changes. To do this, change to the 'Load/Save' tab and click the 'Save' button within the 'Default' section.



Shared connection (do not disconnect other viewers)

This option does not apply to ServSwitch CX Quad IP connections.

Full screen mode

When ticked, the VNC viewer will launch in full screen mode. Use the menu key (usually F8) to exit from full screen mode.

Full screen mode matches server resolution

When ticked, the VNC viewer will attempt to use the screen resolution of the selected host system.

Full screen mode uses all monitors

When ticked, the VNC viewer will show the screen image using all available display monitors on multiple display systems.

Render cursor locally

This option does not currently apply to ServSwitch CX Quad IP connections.

Allow dynamic desktop resizing

When ticked, the viewer window will be automatically resized whenever the host system's screen resolution is altered.

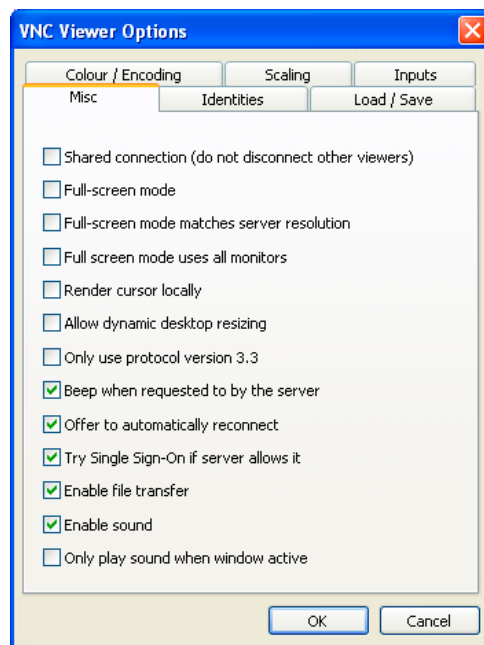
**Only use protocol version 3.3**

This option does not apply to ServSwitch CX Quad IP connections.

Beep when requested to by the server

When ticked, your local system will beep in response to any error beeps emitted by the ServSwitch CX Quad IP.

Offer to automatically reconnect

When ticked, the viewer will offer to restore a lost connection with the server.

Try Single Sign-On if server allows it

This option does not apply to ServSwitch CX Quad IP connections.

Enable file transfer

This option does not apply to ServSwitch CX Quad IP connections.

Enable sound

Not supported.

Only play sound when window active

Not supported.

IMPORTANT: If you make any changes to the options given here and wish to retain them for successive connection sessions, you must save the changes. To do this, change to the 'Load/Save' tab and click the 'Save' button within the 'Default' section.



Scaling

No Scaling

No attempt is made to make the screen image fit the viewer window. You may need to scroll horizontally and/or vertically to view all parts of the screen image.

Scale to Window Size

Adjusts the server screen image to suit the size of the viewer window.

Custom Size

Adjusts the server screen image according to the Width and Height settings in the adjacent fields. A drop box to the right of the fields allows you to define the image size by percentage or by pixels, as required.

Preserve Aspect Ratio

When ticked, maintains a consistent ratio between the horizontal and vertical dimensions of the screen image.

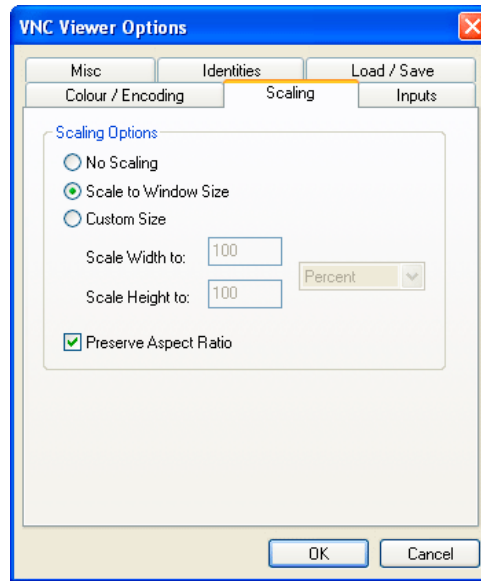

IMPORTANT: If you make any changes to the options given here and wish to retain them for successive connection sessions, you must save the changes. To do this, change to the 'Load/Save' tab and click the 'Save' button within the 'Default' section.



Identities

This feature helps your VNC viewer to confirm that a revisited ServSwitch CX Quad IP is genuine and not another device masquerading as an ServSwitch CX Quad IP. The list given will retain the identities of all visited units (that have full security enabled).

When you first make a secure connection to the ServSwitch CX Quad IP, the security information for that ServSwitch CX Quad IP unit is cached within this Identities tab (i.e. the “identity” is known). The next time that you connect to the ServSwitch CX Quad IP, its identity is checked against the stored version. If a mismatch is found between the current and the stored identities then a warning will be issued to you.

If an existing ServSwitch CX Quad IP is fully reconfigured then it will need to be issued with a new identity. In this case the previous identity, listed in this tab, should be removed so that a new identity can be created on the next connection.

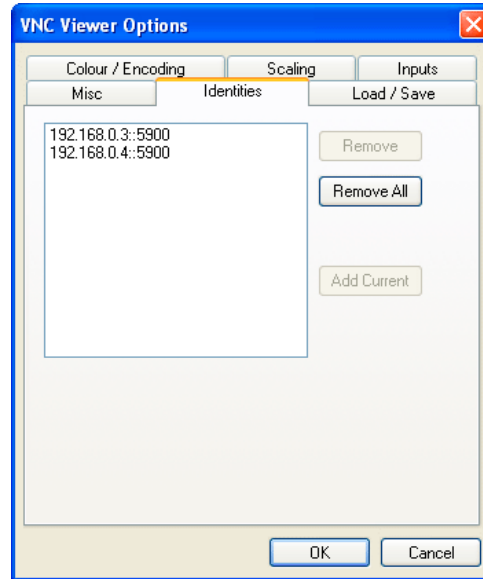

Load / Save

Configuration File - Reload

Allows you to load a configuration file saved from this, or another viewer.

Configuration File - Save

Allows you to save the current settings so that they can be copied from one viewer to another.

Configuration File - Save As...

Allows you to save the current settings under a new name so that they can be copied from one viewer to another.

Defaults - Reload

When clicked, all connection options are returned to the default settings that are currently saved.

Defaults - Save

When clicked, saves the current connection options as the default set that will be used in all subsequent VNC connections.

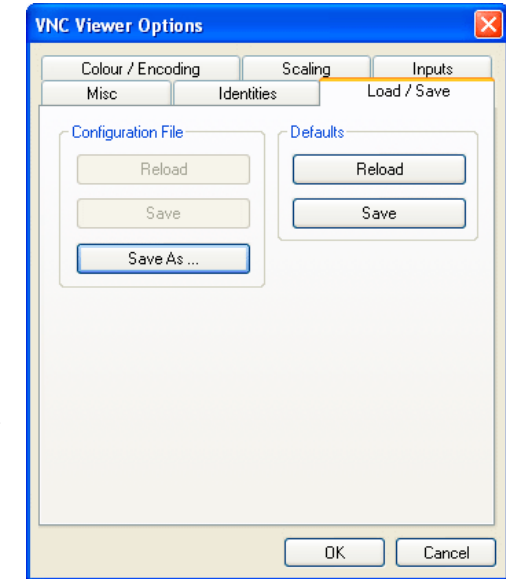

INSTALLATION

CONFIGURATION

OPERATION

FURTHER INFORMATION

INDEX

Appendix 4 - VNC viewer window options

Click the VNC icon in the top left corner of the viewer window (or press F8) to display the window options:

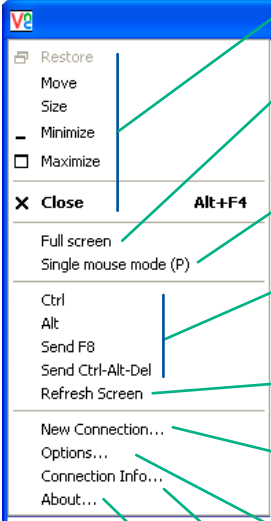
- 
- **Standard window control items**
 - **Full screen**
Expands the VNC viewer window to fill the whole screen with no visible window edges or toolbar. Press F8 to re-display this menu.
 - **Single mouse mode (P)**
Used for fast network connections where a second, "predictor" cursor is not required.
 - **Ctrl, Alt, Send F8, Send Ctrl-Alt-Del**
Sends the selected keypress(es) to the ServSwitch CX Quad IP and host computer. This is necessary because certain keys and key combinations are trapped by the VNC viewer.
 - **Refresh Screen**
Requests data from the server for a complete redraw of the screen image, not just the items that change.
 - **New connection...**
Displays the connection dialog so that you can log on to a different ServSwitch CX Quad IP or VNC server location.
 - **Options...**
Displays the full range of connection options - see [Appendix 3](#) for more details.
 - **Connection info...**
Displays various connection and display details.
 - **About...**
Displays information about your VNC viewer.

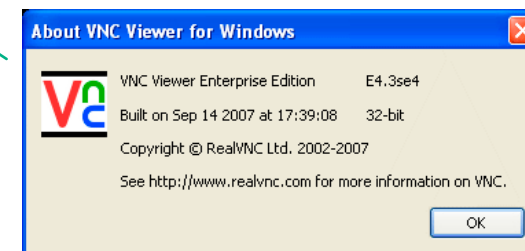
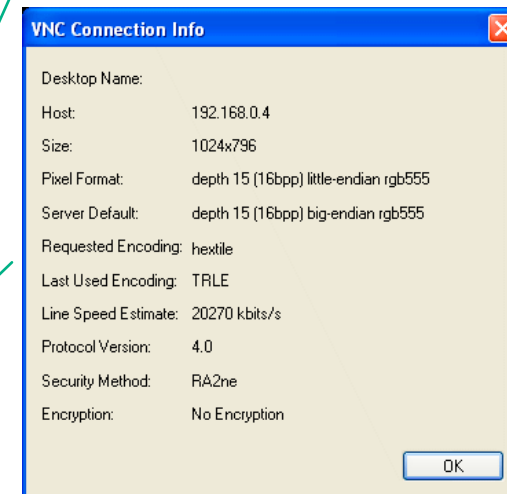
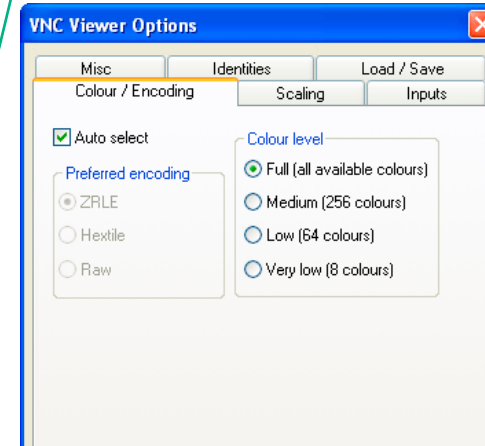
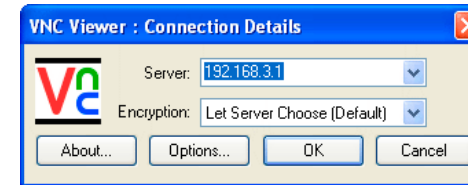

Appendix 5 - Browser viewer options

When you are connecting to the ServSwitch CX Quad IP using a Web browser, a number of options are available.

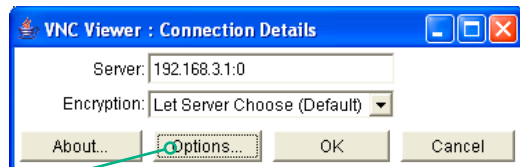

Click here to access the options

There are four options pages:

Encoding and colour level

Auto select

When ticked, this option will examine the speed of your connection to the ServSwitch CX Quad IP and apply the most suitable encoding method. This option is suggested for the majority of installations.

Preferred encoding

There are three manually selectable encoding methods which are accessible when the Auto select option is unticked.

- **ZRLE** – This is a highly compressed method that is best suited to slow modem connections.
- **Hextile** – This method offers better performance than the ZRLE when used over a high speed network because there is no need for the ServSwitch CX Quad IP to spend time highly compressing the data.
- **Raw** – This is a primitive, uncompressed method that is mainly used for technical support issues. You are recommended not to use this method.

Colour level

The colour level is fixed at Medium (256 colours) for almost all browsers.

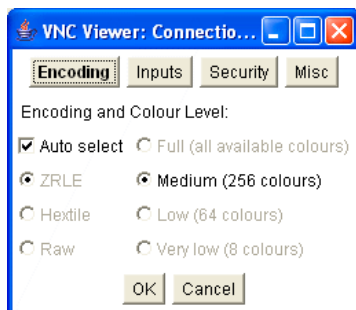

Inputs

View only (ignore mouse & keyboard)

When ticked, the viewer will not send keyboard or mouse information to the ServSwitch CX Quad IP or host computer.

Accept clipboard from server

This feature is restricted to software server versions of VNC and has no effect on ServSwitch CX Quad IP installations.

Send clipboard to server

This feature is restricted to software server versions of VNC and has no effect on ServSwitch CX Quad IP installations.

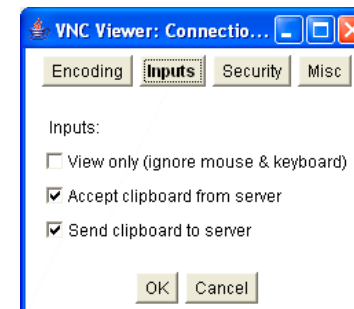

Security

512 bits (low security)

Selects the lowest level of encoding for communications between the browser and the ServSwitch CX Quad IP.

1024 bits (medium security)

Selects the middle level of encoding for communications between the browser and the ServSwitch CX Quad IP.

2048 bits (high security)

Selects the highest level of encoding for communications between the browser and the ServSwitch CX Quad IP.

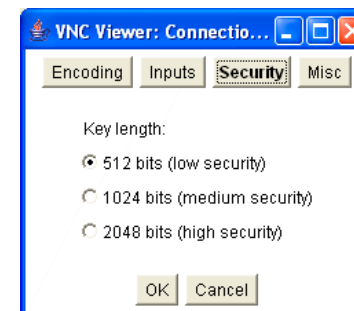

Misc

Shared (don't disconnect other viewers)

This feature is restricted to software server versions of VNC and has no effect on ServSwitch CX Quad IP installations.

Render cursor locally

This feature is restricted to software server versions of VNC and has no effect on ServSwitch CX Quad IP installations.

Fast CopyRect

This feature is restricted to software server versions of VNC and has no effect on ServSwitch CX Quad IP installations.

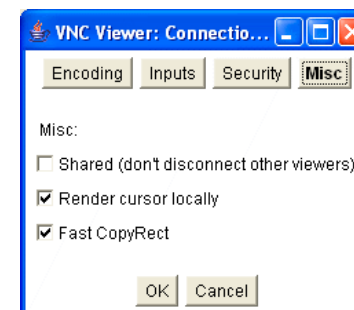

INSTALLATION

CONFIGURATION

OPERATION

FURTHER INFORMATION

INDEX

Appendix 6 – Addresses, masks and ports

IP address, network masks and ports are all closely linked in the quest for one device to find another across disparate network links.

IP addresses

As a rough analogy, consider how you use the telephone system. The phone number for Black Box in the US is **1-724-746-5500**. This number consists of three distinct parts:

- **1** connects from another country to the US,
- **724** connects into Pennsylvania,
- **746** selects the telephone exchange in Lawrence, and
- **5500** is the unique code for Black Box within Lawrence.

The important parts of the whole number depend on where you are. If you were based in the same local area as Black Box, there would be no point in dialling out of the US, or even out of the area. The only part of the whole number that you are interested in is the final part: **5500**.

In a similar way to the various parts of the telephone number, the four sections (or *Octets*) of every IP address have different meanings or “weights”. Consider the following typical IP address:

192.168.142.154

192 is the most global part of the number (akin to the *1* of the phone number) and **154** is the most local (similar to the *5500* unique local code of the phone number).

When two network devices communicate with each other, they always “dial the whole number” regardless of their respective locations in a network. However, they still need to know whether the other device is local to them or not, and this is where the net mask comes into play.

Net masks

The net mask (or sub-net mask) informs a device as to its own position within a network. From this it can determine whether any other device is within the same local network or is situated further afield.

Taking the telephone number analogy given in the IP address section, in order to use the telephone system efficiently, it is vital for you to know your location relative to the person you are calling. In this way you avoid dialling unnecessary numbers.

When one network device needs to talk to another, the first thing that it will do is a quick calculation using its own IP address, the other device’s IP address and its own net mask. Suppose a device with address **192.168.142.154** and net mask **255.255.255.0** needed to communicate with a device at address **192.168.142.22**. The sending device would perform several calculations:

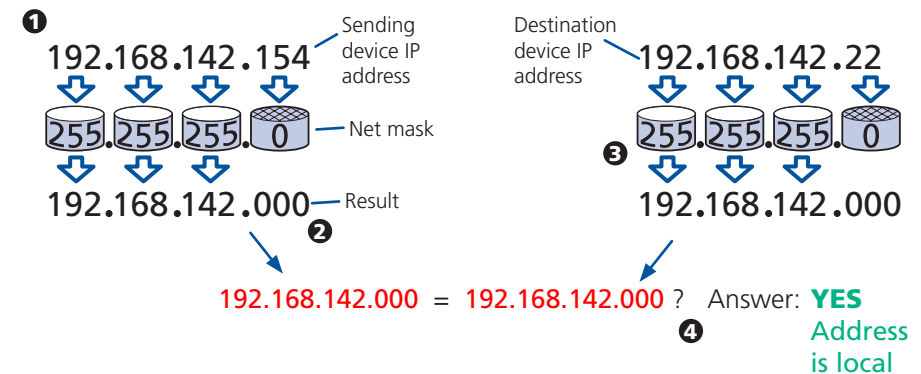

- 1** The net mask is used to determine the local and global parts of the sender’s IP address. Where there is 255 in the mask, the corresponding address slips through, where there is a 0, it is blocked.
- 2** Where the net mask was 0, the corresponding part of the result is also zero - this section is now known to be the local part of the IP address.
- 3** The same process is carried out for the destination address, again using the sender’s net mask. Now the local parts of both addresses have been equalized to zero, because their values are not important in determining whether they are both in the same local network.
- 4** The results of the two net mask operations are now compared, if they match, the destination is local. If not, then the sender will still use the same full destination IP address but will also flag the message to go via the local network gateway and out into the wider world.

The reason for doing this? It makes the network, as a whole, much more efficient. If every message for every recipient was shoved straight out onto the Internet, the whole thing would grind to a halt within seconds. Net masks keep local traffic just that - local.

[Want to know more?](#)





Net masks - the binary explanation

To really understand the operation of a net mask it is necessary to delve deeper into the life blood of computers – *binary*; this is native digital, where everything is either a 1 (one) or 0 (zero), on or off, yes or no.

The net mask operation described on the [previous page](#) is known as a ‘bit-wise AND function’. The example of 255.255.255.0 is handy because the last octet is completely zero and is “clean” for illustrative purposes. However, actual net mask calculations are carried out, not on whole decimal numbers, but bit by bit on binary numbers, hence the term ‘bit-wise’. In a real local network, a net mask might be 255.255.255.240. Such an example would no longer be quite so clear, until you look at the net mask in its binary form:

11111111.11111111.11111111.11110000

In this case, the four zeroes at the end of the net mask indicate that the local part of the address is formed by only the last four bits. If you use the diagram from the previous example and insert the new net mask, it will have the following effect on the final result:

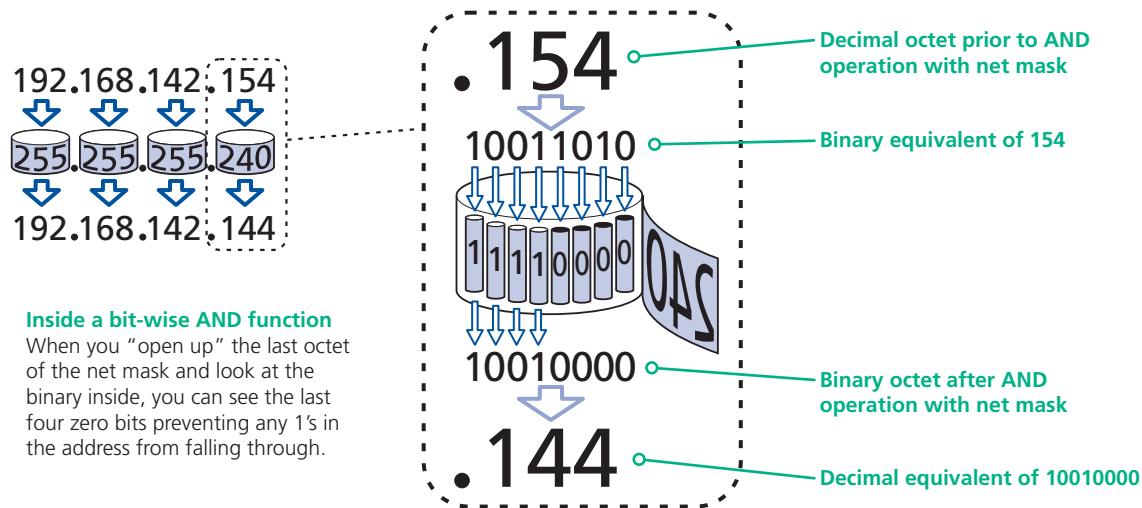

Thus, when 154 is *bit-wise ANDed* with 240, the result is 144. Likewise, any local address from 192.168.142.144 through to 192.168.142.159 would produce exactly the same result when combined with this net mask, hence they would all be local addresses. However, any difference in the upper three octets or the upper four bits of the last octet would slip through the mask and the address would be flagged as not being local.



Calculating the mask for IP access control

The IP access control function uses a standard IP address and a net mask notation to specify both single locations and ranges of addresses. In order to use this function correctly, you need to calculate the mask so that it accurately encompasses the required address(es).

Single locations

Some of the simplest addresses to allow or deny are single locations. In this case you enter the required IP address into the 'Network/Address' field and simply enter the 'Mask' as **255.255.255.255** (*255 used throughout the mask means that every bit of the address will be compared and so there can only be one unique address to match the one stated in the 'Network/Address' field*).

All locations

The other easy setting to make is ALL addresses, using the mask **0.0.0.0**. As standard, the IP access control section includes the entry: **+0.0.0.0/0.0.0.0**. The purpose of this entry is to *include* all IP addresses. It is possible to similarly *exclude* all addresses, however, take great care not to do this as you instantly render all network access void. There is a [recovery procedure](#) should this occur.

Address ranges

Although you can define ranges of addresses, due to the way that the mask operates, there are certain restrictions on the particular ranges that can be set. For any given address you can encompass neighbouring addresses in blocks of either 2, 4, 8, 16, 32, 64, 128, etc. and these must fall on particular boundaries. For instance, if you wanted to define the local address range:

192.168.142.67 to 192.168.142.93

The closest single block to cover the range would be the 32 addresses from:

192.168.142.64 to 192.168.142.95.

The mask needed to accomplish this would be: **255.255.255.224**

When you look at the mask in binary, the picture becomes a little clearer. The above mask has the form: **11111111.11111111.11111111.11100000**

Ignoring the initial three octets, the final six zeroes of the mask would ensure that the 32 addresses from .64 (01000000) to .95 (01011111) would all be treated in the same manner. See [Net masks - the binary explanation](#) for details.

When defining a mask, the important rule to remember is:

There must be no 'ones' to the right of a 'zero'.

For instance, (ignoring the first three octets) you could not use a mask that had **11100110** because this would affect intermittent addresses within a range in an impractical manner. The same rule applies across the octets. For example, if you have zeroes in the third octet, then all of the fourth octet must be zeroes.

The permissible mask values (for all octets) are as follows:

Mask octet	Binary	Number of addresses encompassed
255	11111111	1 address
254	11111110	2 addresses
252	11111100	4 addresses
248	11111000	8 addresses
240	11110000	16 addresses
224	11100000	32 addresses
192	11000000	64 addresses
128	10000000	128 addresses
0	00000000	256 addresses

If the access control range that you need to define is not possible using one address and one mask, then you could break it down into two or more entries. Each of these entries could then use smaller ranges (of differing sizes) that, when combined with the other entries, cover the range that you require.

For instance, to accurately encompass the range in the earlier example:

192.168.142.67 to 192.168.142.93

You would need to define the following six address and mask combinations in the IP access control section:

Network/address entry	Mask entry	
192.168.142.67	255.255.255.255	defines 1 address (.67)
192.168.142.68	255.255.255.252	defines 4 addresses (.68 to .71)
192.168.142.72	255.255.255.248	defines 8 addresses (.72 to .79)
192.168.142.80	255.255.255.248	defines 8 addresses (.80 to .87)
192.168.142.88	255.255.255.252	defines 4 addresses (.88 to .92)
192.168.142.93	255.255.255.255	defines 1 address (.93)

Ports

If you accept the analogy of [IP addresses](#) being rather like telephone numbers, then think of ports as extension numbers. In a company of any size, you generally wouldn't expect the accounts department to share the same telephone with the technical department. Although their calls may all be related to the same company, they concern very different aspects of that company.

It is the same with IP network connections. Although you have only one network link into your computer and only one IP address (phone number), you are probably performing many different tasks through that one link, often at the same time. Thus, when you browse the web your outgoing requests and the incoming information are all channelled through port 80. When you send an email, it travels through port 25 and when you transfer files you are, without knowing it, using port 20.

At the "border crossing" between the wider Internet and every local network attached to it, there is a router that is usually combined with a firewall. One of its main tasks is to direct incoming traffic to the correct place within its local network. A key piece of information to help it do this is the port number:

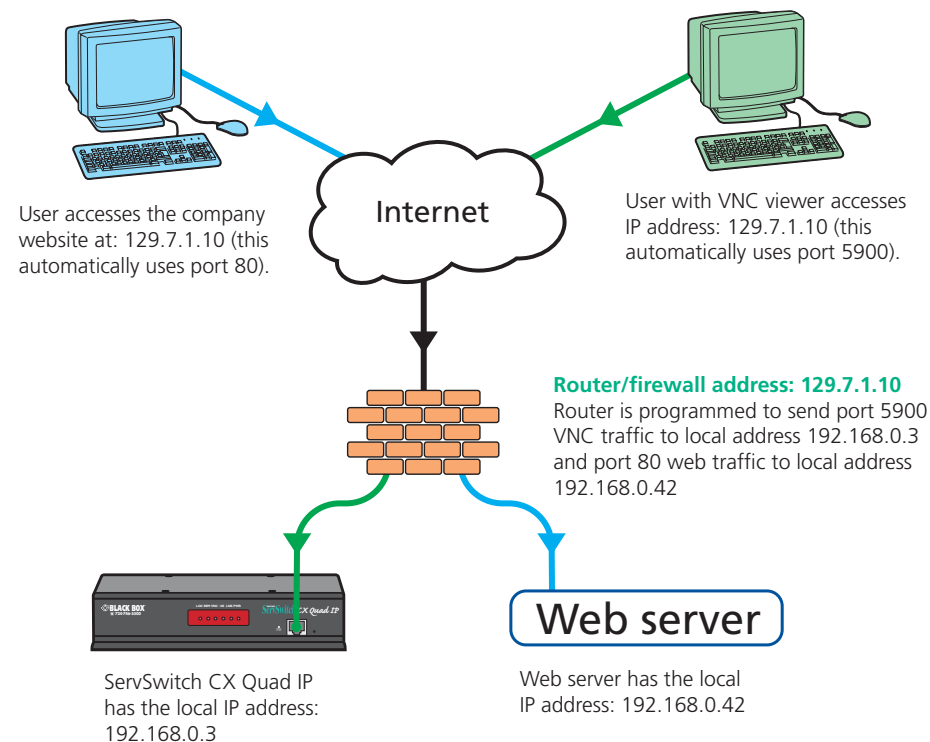

Security issues with ports

The settings of port numbers become important when the ServSwitch CX Quad IP is situated behind a network firewall. In order for a remote VNC viewer or web browser to make contact with your ServSwitch CX Quad IP, it is necessary for the firewall to allow communication through a particular numbered port to occur.

One specific function of firewalls is to restrict access to ports in order to prevent malicious attackers using them as a route into your network. Every new port that is opened offers a new possibility for hackers and so the number of accessible ports is purposefully kept to a minimum. In such cases, it may be advantageous to change one or both ServSwitch CX Quad IP ports to use the same number. The other alternative is to place the ServSwitch CX Quad IP unit outside the firewall and take full advantage of its secure operation features – see [Networking issues](#) for details.

IMPORTANT: The correct configuration of routers and firewalls requires advanced networking skills and intimate knowledge of the particular network. Black Box cannot provide specific advice on how to configure your network devices and strongly recommend that such tasks are carried out by a qualified professional.



INSTALLATION

CONFIGURATION

OPERATION

FURTHER INFORMATION

INDEX

Appendix 7 – Cascading multiple units



When you need to control more than sixteen host computers using ServSwitch CX Quad IP units, there are two main ways to achieve this:

- The preferred method is to use multiple ServSwitch CX Quad IP units to control groups of sixteen hosts and then use the WIZARD.NET utility to manage the interactions of multiple users with those hosts. This method is described in the section [Creating larger installations](#).
- The alternative method is to cascade ServSwitch CX Uno units from the ports of the original ServSwitch CX Quad IP unit. Up to sixteen hosts can then be linked to each of the secondary ServSwitch CX Uno units. The combination of ServSwitch units can be arranged two levels deep forming a tree, or *cascade* arrangement, with computer systems situated at either level within that cascade tree.

The limitation of the latter method is that the local and global users linking into the ServSwitch CX Quad IP unit can all only view one host system at a time due to the single pathways formed by the connections between the ServSwitch units.

This section details the configuration and operation of a cascade system for completeness.

Note: It is not possible to cascade two ServSwitch CX Quad IP units together because they do not have a Remote User Port on their front panels. The lower units must always be the non-IP ServSwitch CX Uno variants.

See also

- [Connecting units in cascade](#)
- [Addressing computers in a cascade](#)

The cascade tree

The diagram shows how an ServSwitch CX Quad IP unit and multiple ServSwitch CX Uno units can be cascaded to two levels. Computer systems can be connected at any level. The local or global users can access computer systems situated anywhere within the cascade tree.

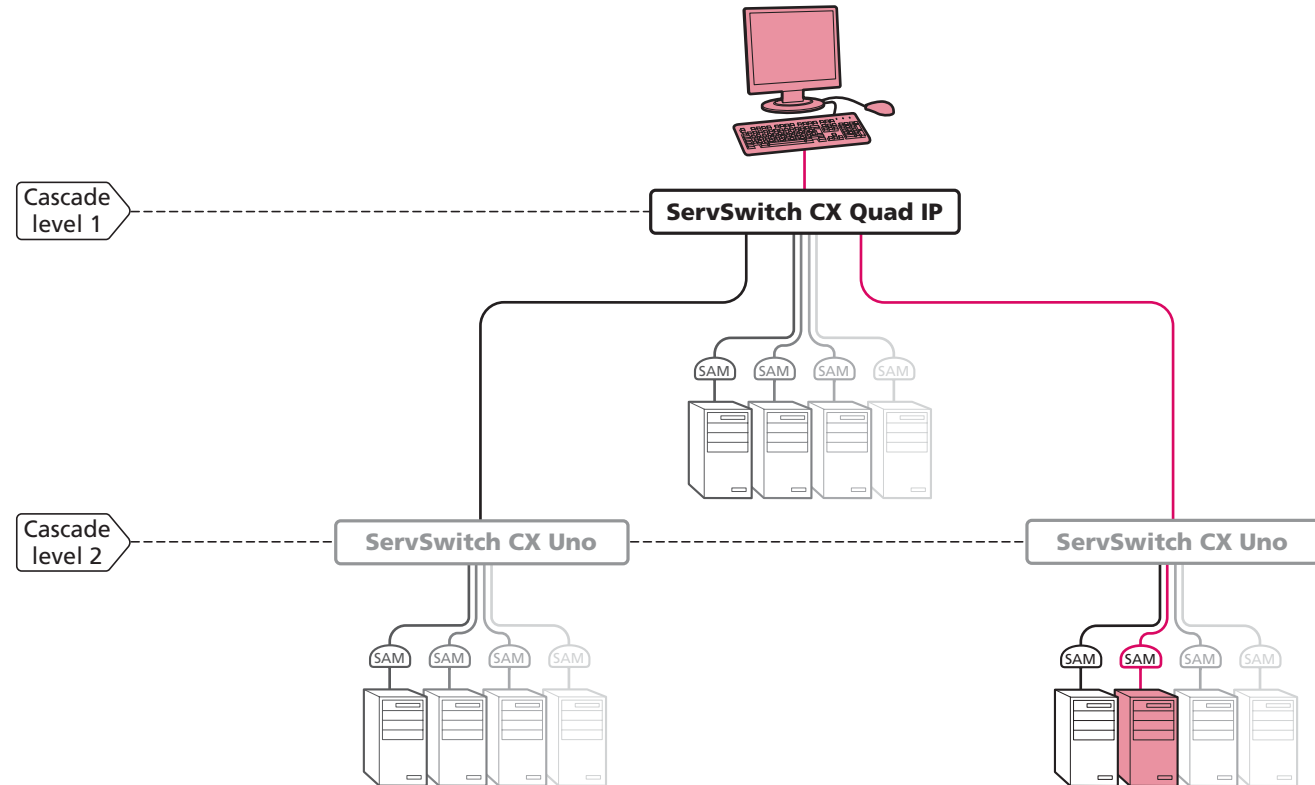

Connecting units in cascade

The method for cascading ServSwitch CX Quad IP and ServSwitch CX Uno units is straightforward and requires no hardware settings or lengthy configuration process.

The method of linking units is the same regardless of the cascade level, or number of devices attached. Put simply:

- A single cascade link is made by connecting a **COMPUTER CONNECTIONS** socket of the **ServSwitch CX Quad IP** unit to the **REMOTE USER PORT** socket of the **ServSwitch CX Uno** unit below it.

Please consider the following when making cascade connections between units.

Tips for successful cascading

- The maximum number of levels for a cascade is two.
- For each cascade link, use a standard category 5, 5e or 6 twisted-pair cable, terminated at each end with an RJ45 connector. There must be no crossover connections within the cable. The cascade link cables can be up to 10m (32 feet) in length providing that the total length from the ServSwitch CX Quad IP or ServSwitch CX Uno to any SAM also does not exceed 10m.
- The procedure given opposite may be carried out in any order but for clarity the instruction will begin at the ServSwitch CX Quad IP unit. The procedure remains the same regardless of exactly which cascade levels are being connected. The basic rule is that each link is made by connecting a **COMPUTER CONNECTIONS** port of the **ServSwitch CX Quad IP** (upper switch) to the **REMOTE USER PORT** (on the front panel) of the **ServSwitch CX Uno**.

To connect units in cascade

- 1 Ensure that power is disconnected from the ServSwitch CX Quad IP and all other units to be connected.
- 2 Connect one end of the cascade link cable to an appropriate **COMPUTER CONNECTIONS** port on the rear panel of the ServSwitch CX Quad IP.

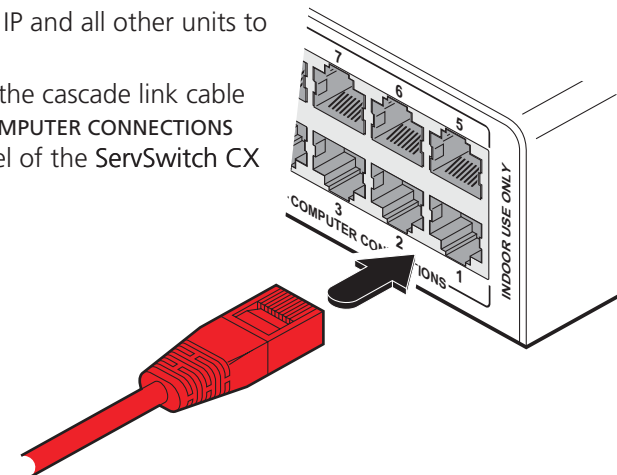

- 3 Connect the other end of the cascade link cable to the remote user port (RJ45 socket) on the front panel of the ServSwitch CX Uno unit.
- 4 Repeat steps 2 and 3 for the cascade links between the ServSwitch CX Quad IP and each ServSwitch CX Uno unit.

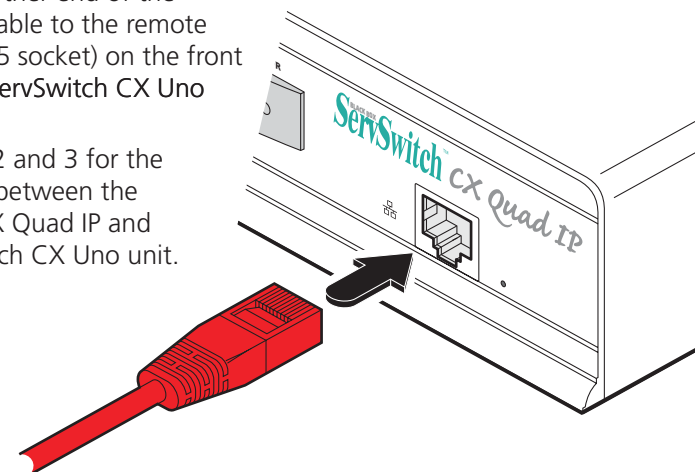

Once the units and computers have been connected, you can edit their names to make it much easier to locate them. See the [To create a new host entry](#) section in the 'Host configuration' page of [Appendix 2](#) for more details.

See also

- [Addressing computers in a cascade](#)



INSTALLATION

CONFIGURATION

OPERATION

FURTHER INFORMATION

INDEX

Addressing computers in a cascade

Computer systems connected within a cascade arrangement are addressed using up to four digits, two for each cascade level. The pairs of digits specify which of the **COMPUTER CONNECTIONS** ports on each of the ServSwitch CX Uno units must be enabled to reach a specific computer. In the diagram given here, a portion of the previous cascade diagram indicates how the routes to two particular computers are formed and addressed.

Each cascade level requires two digits, hence the computer marked in red requires a longer address (1203) as it is situated at cascade level 2, compared to the blue computer at the top level with its two digit port number.

The first time that you make a connection between an ServSwitch CX Quad IP and an ServSwitch CX Uno, the master unit will detect this and ask (via the on screen menu) if you want to automatically add computers. If you choose 'Yes' then the ports on the cascade will be automatically added to the on screen menu.

Using cascaded computers

In use, cascaded computers can be accessed using exactly the same methods as for those connected directly to the ServSwitch CX Quad IP. However, by far the easiest way is to use the on screen menu. This is because it displays the computer names and does not require any knowledge of port addresses. See either [Selecting a computer](#) (for local user access) or [Host selection](#) (for global user access) for more details.

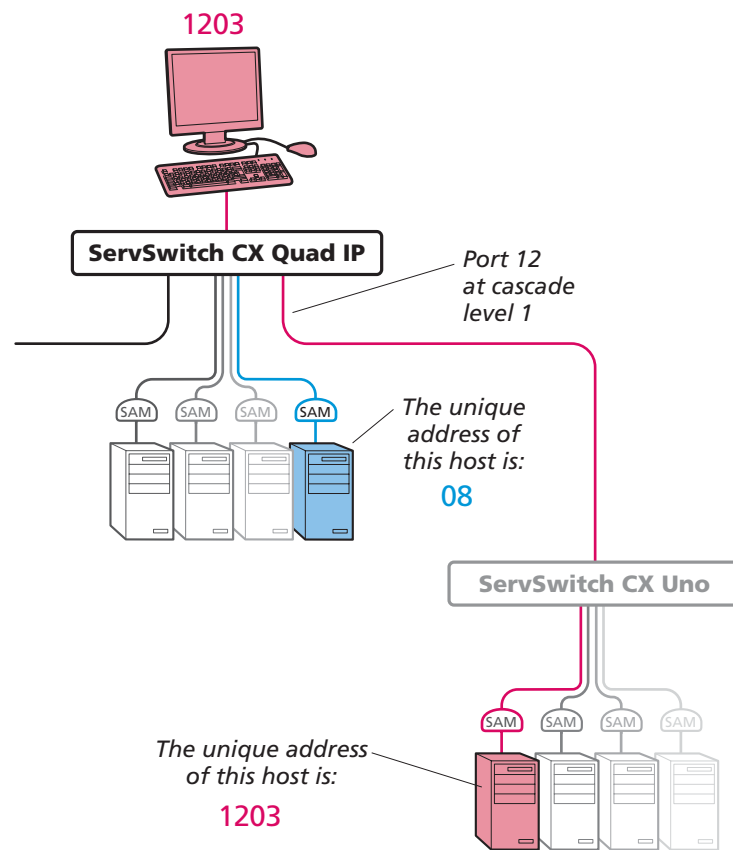

INSTALLATION

CONFIGURATION

OPERATION

FURTHER INFORMATION

INDEX

Appendix 8 – Cable and connector specifications



ServSwitch CX Quad IP to power switch cable

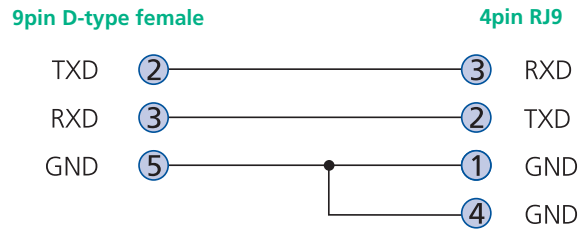

Power switch to power switch daisy chain cable

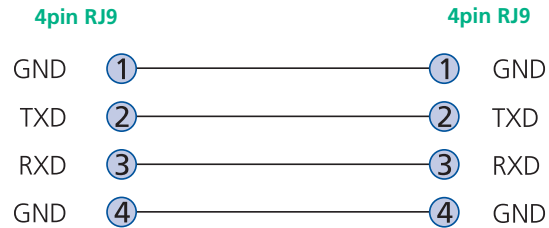

Multi-head synchronisation cable

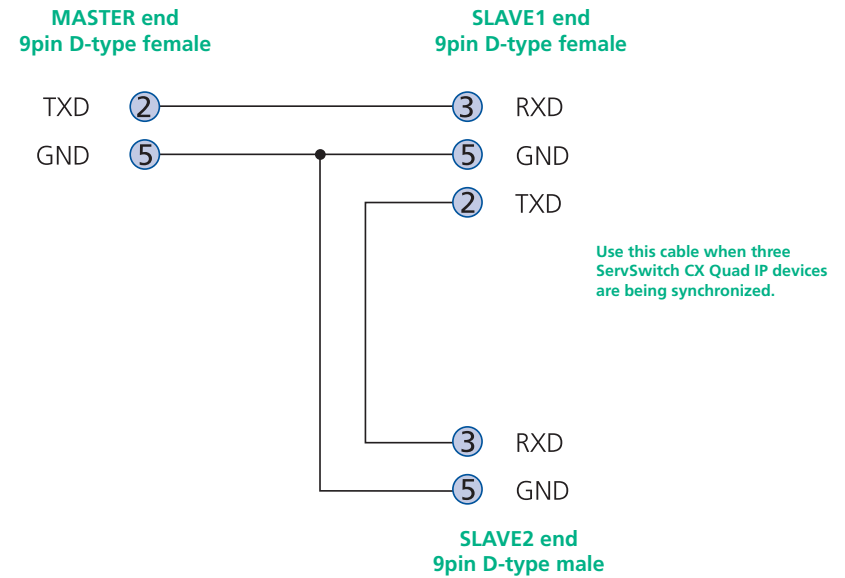
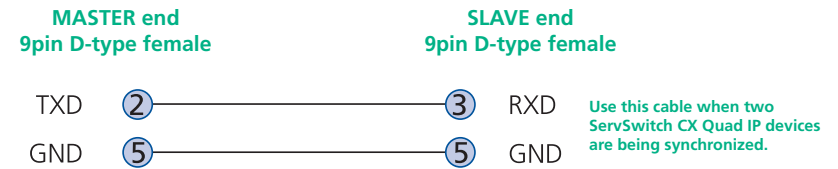

INSTALLATION

CONFIGURATION

OPERATION

FURTHER INFORMATION

INDEX

Appendix 9 – Hotkey sequence codes

These codes are used when defining hotkey switching sequences (macros) for host computers and allow you to include almost any of the special keys on the keyboard.

Permissible key presses

Main control keys (see 'Using abbreviations')

Backspace | Tab | Return | Enter | Ctrl | Alt | Win | Shift | LShift | RShift
LCtrl | RCtrl | LAlt | AltGr | RAlt | LWin | RWin | Menu | Escape | Space
CapsLock | NumLock | PrintScreen | Scrolllock

Math operand keys (see 'Using abbreviations')

Add (Plus) | Subtract (Minus) | Multiply

Central control keys (see 'Using abbreviations')

Insert | Delete | Home | End | PageUp | PageDown
Up | Down | Left | Right | Print | Pause

Keypad keys (see 'Using abbreviations')

KP_Insert | KP_Delete | KP_Home | KP_End | KP_PageUp
KP_PageDown | KP_Up | KP_Down | KP_Left | KP_Right | KP_Enter
KP_Add | KP_Subtract | KP_Divide | KP_Multiply
KP_0 to KP_9

Function keys

F1 | F2 | F3 | F4 | F5 | F6 | F7 | F8 | F9 | F10 | F11 | F12

ASCII characters

All characters can be entered using their ASCII codes, from 32 to 126 (i.e. A,B,C, ... 1,2,3 etc.) with the exception of the special characters '+', '-', '+-' and '*' which have special meanings, as explained below.

Codes with special meanings

- + means press down the key that follows
- means release the key that follows
- +– means press down and release the key that follows
- * means wait 250ms (note: if a number immediately follows the asterisk, then the delay will equal the number, in milliseconds)

Note: Hotkey sequences are not case sensitive.

Creating macro sequences

Hot key macro sequences can be up to 256 characters long. All keys are assumed to be released at the end of a line, however, you can also determine that a key is pressed and released within a sequence. Any of the following three examples will send a command that emulates and a press and release of the Scroll Lock key:

```
+SCROLL-SCROLL  
+-SCROLL  
+SCROLL-
```

Example:

```
+-SCROLL+-SCROLL+1+ENTER
```

Press and release scroll twice, press 1 then enter then release all keys (equivalent definition is +SCROLL-SCROLL+SCROLL-SCROLL+1+ENTER-1-ENTER)

Using abbreviations

To reduce the length of the key definitions, any unique abbreviation for a key can be used. For example: "scroll", "scr" and even "sc" all provide an identifiable match for "ScrollLock" whereas "en" could not be used because it might mean "Enter" or "End" ("ent" would be suitable for "Enter").

Note: Hotkey sequences and abbreviations are not case sensitive.

For information about where to enter these codes, please see the section [Keyboard control](#).



Appendix 10 – Supported video modes

The following video modes are supported and can be automatically configured by the ServSwitch CX Quad IP units. Support for VESA GTF (Generalized Timing Formula) is available and can be enabled via the [Advanced Unit Configuration](#) screen.

The support for VESA modes conforming to GTF is up to 1920 x 1200 @ 60Hz although video modes above 1600 x 1200 @ 60 Hz are instead displayed as half-width modes. The half width video modes capture every other pixel. These are not generally recommended for normal use but may be used for emergency access to high resolution, high frequency system screens. Half width screens can be expanded to normal width using the scaling features of the viewer.

vesa 720 x 400 @ 85Hz	sun 1152 x 900 @ 66Hz
vesa 640 x 480 @ 60Hz	sun 1152 x 900 @ 76Hz
vesa 640 x 480 @ 72Hz	sun 1280 x 1024 @ 67Hz
vesa 640 x 480 @ 75Hz	apple 640 x 480 @ 67Hz
vesa 640 x 480 @ 85Hz	apple 832 x 624 @ 75Hz
vesa 800 x 600 @ 56Hz	apple 1152 x 870 @ 75Hz
vesa 800 x 600 @ 60Hz	1920 x 1200 @ 60Hz**
vesa 800 x 600 @ 72Hz	
vesa 800 x 600 @ 75Hz	
vesa 800 x 600 @ 85Hz	
vesa 1024 x 768 @ 60Hz	
vesa 1024 x 768 @ 70Hz	
vesa 1024 x 768 @ 75Hz	
vesa 1024 x 768 @ 85Hz	
vesa 1152 x 864 @ 75Hz	
vesa 1280 x 960 @ 60Hz	
vesa 1280 x 1024 @ 60Hz	
vesa 1280 x 1024 @ 75Hz	
vesa 1600 x 1200 @ 60Hz	
vesa 720 x 400 @ 70Hz*	

* Not actually a VESA mode but a common DOS/BIOS mode

** This mode is displayed as a half width video mode via a VNC viewer.



INSTALLATION

CONFIGURATION

OPERATION

FURTHER
INFORMATION

INDEX

Safety information

- For use in dry, oil free indoor environments only.
- Both the ServSwitch CX Quad IP and its power supply generate heat when in operation and will become warm to the touch. Do not enclose them or place them locations where air cannot circulate to cool the equipment. Do not operate the equipment in ambient temperatures exceeding 40 degrees Centigrade. Do not place the products in contact with equipment whose surface temperature exceeds 40 degrees Centigrade.
- Warning - live parts contained within power adapter.
- No user serviceable parts within power adapter - do not dismantle.
- Plug the power adapter into a socket outlet close to the module that it is powering.
- Replace the power adapter with a manufacturer approved type only.
- Do not use the power adapter if the power adapter case becomes damaged, cracked or broken or if you suspect that it is not operating properly.
- If you use a power extension cord with the ServSwitch CX Quad IP, make sure the total ampere rating of the devices plugged into the extension cord does not exceed the cord's ampere rating. Also, make sure that the total ampere rating of all the devices plugged into the wall outlet does not exceed the wall outlet's ampere rating.
- Do not attempt to service the ServSwitch CX Quad IP yourself.

Safety considerations when using power switches with ServSwitch CX Quad IP

- Follow the manufacturer's instructions when setting up and using power switching products.
- Always ensure that the total ampere rating of the devices plugged into the power switching product does not exceed the power switching product's ampere rating. Also, make sure that the total ampere rating of all the devices plugged into the wall outlet does not exceed the wall outlet's ampere rating.

General Public License (Linux)

The ServSwitch CX Quad IP runs an embedded version of the Linux operating system, licensed under the GNU General Public License. To obtain the source code for the open-source components of the system visit:

<http://www.adventiq.com/products/ARQ3/gpl.html>



INSTALLATION

CONFIGURATION

OPERATION

FURTHER
INFORMATION

INDEX

End user licence agreement

PLEASE READ THIS AGREEMENT CAREFULLY. THIS AGREEMENT CONCERNS ENHANCED VNC VIEWER SOFTWARE (“the SOFTWARE”) FOR USE WITH THE SERVSWITCH CX Quad IP PRODUCT (“the PRODUCT”). THE SOFTWARE IS PROVIDED TO ENABLE YOU TO OPERATE THE PRODUCT. BY USING ALL OR ANY PORTION OF THE SOFTWARE YOU ACCEPT ALL THE TERMS AND CONDITIONS OF THIS AGREEMENT. IF YOU DO NOT ACCEPT ALL THE TERMS AND CONDITIONS OF THIS AGREEMENT THEN DO NOT USE THE SOFTWARE. BY USING ANY UPDATED VERSION OF THE SOFTWARE WHICH MAY BE MADE AVAILABLE, YOU ACCEPT THAT THE TERMS OF THIS AGREEMENT APPLY TO SUCH UPDATED SOFTWARE.

1. Intellectual Property Rights

The Software and its structure and algorithms are protected by copyright and other intellectual property laws, and all intellectual property rights in them belong to RealVNC Limited (“RealVNC”), a United Kingdom Limited Company, or are licensed to it. You may not reproduce, publish, transmit, modify, create derivative works from, publicly display the Software or part thereof. Copying or storing or using the Software other than as permitted in Clause 2 is expressly prohibited unless you obtain prior written permission from RealVNC.

2. Permitted and Prohibited Uses

- 2.1 During the term of this Agreement and as long as you comply with the terms of this agreement, you may use the Software only with the Product for your personal use or for the internal use of your business. You may make as many copies of the Software as you require for your own internal business purposes only and for archival purposes. You are expressly prohibited from distributing the Software in any format, in whole or in part, for sale, or for commercial use or for any unlawful purpose.
- 2.2 You may not rent, lease or otherwise transfer the Software or allow it to be copied. Unless permitted by law, you may not reverse engineer, decompile or disassemble the Software.

3. Warranty

REALVNC DOES NOT WARRANT ANY RESULTS OBTAINED USING THE SOFTWARE. TO THE EXTENT PERMITTED BY LAW, REALVNC DISCLAIMS ALL OTHER WARRANTIES ON THE SOFTWARE, EITHER EXPRESS OR IMPLIED, INCLUDING BUT NOT LIMITED TO THE IMPLIED WARRANTIES OF MERCHANTABILITY, NON-INFRINGEMENT OF THIRD PARTY RIGHTS AND FITNESS FOR PARTICULAR PURPOSE.

4. Limitation on Liability

UNDER NO CIRCUMSTANCES SHALL REALVNC BE LIABLE FOR ANY CONSEQUENTIAL INDIRECT OR INCIDENTAL DAMAGES WHATSOEVER INCLUDING LOST PROFITS OR SAVINGS ARISING OUT OF THE USE OF THE SOFTWARE, THE SERVICE OR THE INFORMATION, RELIANCE ON THE DATA PRODUCED OR INABILITY TO USE THE SOFTWARE, THE SERVICE OR THE INFORMATION EVEN IF REALVNC HAS BEEN ADVISED OF THE POSSIBILITY OF SUCH DAMAGES. BECAUSE SOME STATES AND COUNTRIES DO NOT ALLOW THE EXCLUSION OR LIMITATION OF LIABILITY FOR CONSEQUENTIAL OR INCIDENTAL DAMAGES, THE ABOVE LIMITATION MAY NOT APPLY TO YOU. NOTHING IN THIS AGREEMENT LIMITS LIABILITY FOR DEATH OR PERSONAL INJURY ARISING FROM A PARTY’S NEGLIGENCE OR FROM FRAUDULENT MISREPRESENTATION ON THE PART OF A PARTY

5. Export Control

The United States and other countries control the export of Software and information. You are responsible for compliance with the laws of your local jurisdiction regarding the import, export or re-export of the Software, and agree to comply with such restrictions and not to export or re-export the Software where this is prohibited. By downloading the Software, you are agreeing that you are not a person or entity to which such export is prohibited.

6. Term and Termination

This licence shall continue in force unless and until it is terminated by RealVNC by e-mail notice to you, if it reasonably believes that you have breached a material term of this Agreement

In the case above, you must delete and destroy all copies of the Software in your possession and control and overwrite any electronic memory or storage locations containing the Software.

7. General Terms

- 7.1 The construction, validity and performance of this Agreement shall be governed in all respects by English law, and the Parties agree to submit to the exclusive jurisdiction of the English courts.
- 7.2 If any provision of this agreement is found to be invalid by any court having competent jurisdiction, the invalidity of such provision shall not affect the validity of the remaining provisions of this agreement, which shall remain in full force and effect.
- 7.3 No waiver of any term of this agreement shall be deemed a further or continuing waiver of such term or any other term.
- 7.4 This agreement constitutes the entire agreement between you and RealVNC.



INSTALLATION

CONFIGURATION

OPERATION

FURTHER INFORMATION

INDEX

Radio Frequency Energy

A Category 5 (or better) twisted pair cable must be used to connect the units in order to maintain compliance with radio frequency energy emission regulations and ensure a suitably high level of immunity to electromagnetic disturbances.

All other interface cables used with this equipment must be shielded in order to maintain compliance with radio frequency energy emission regulations and ensure a suitably high level of immunity to electromagnetic disturbances.

European EMC directive 89/336/EEC

This equipment has been tested and found to comply with the limits for a class A computing device in accordance with the specifications in the European standards EN55022 and EN55024. These limits are designed to provide reasonable protection against harmful interference. This equipment generates, uses and can radiate radio frequency energy and if not installed and used in accordance with the instructions may cause harmful interference to radio or television reception. However, there is no guarantee that harmful interference will not occur in a particular installation. If this equipment does cause interference to radio or television reception, which can be determined by turning the equipment on and off, the user is encouraged to correct the interference with one or more of the following measures: (a) Reorient or relocate the receiving antenna. (b) Increase the separation between the equipment and the receiver. (c) Connect the equipment to an outlet on a circuit different from that to which the receiver is connected. (d) Consult the supplier or an experienced radio/TV technician for help.

FCC Compliance Statement (United States)

This equipment generates, uses and can radiate radio frequency energy and if not installed and used properly, that is, in strict accordance with the manufacturer's instructions, may cause interference to radio communication. It has been tested and found to comply with the limits for a class A computing device in accordance with the specifications in Subpart J of part 15 of FCC rules, which are designed to provide reasonable protection against such interference when the equipment is operated in a commercial environment. Operation of this equipment in a residential area may cause interference, in which case the user at his own expense will be required to take whatever measures may be necessary to correct the interference. Changes or modifications not expressly approved by the manufacturer could void the user's authority to operate the equipment.

Canadian Department of Communications RFI statement

This equipment does not exceed the class A limits for radio noise emissions from digital apparatus set out in the radio interference regulations of the Canadian Department of Communications.

Le présent appareil numérique n'émet pas de bruits radioélectriques dépassant les limites applicables aux appareils numériques de la classe A prescrites dans le règlement sur le brouillage radioélectriques publié par le ministère des Communications du Canada.



INSTALLATION

CONFIGURATION

OPERATION

FURTHER INFORMATION

INDEX

Normas Oficiales Mexicanas (NOM) electrical safety statement



Instrucciones de seguridad

- 1 Todas las instrucciones de seguridad y operación deberán ser leídas antes de que el aparato eléctrico sea operado.
- 2 Las instrucciones de seguridad y operación deberán ser guardadas para referencia futura.
- 3 Todas las advertencias en el aparato eléctrico y en sus instrucciones de operación deben ser respetadas.
- 4 Todas las instrucciones de operación y uso deben ser seguidas.
- 5 El aparato eléctrico no deberá ser usado cerca del agua—por ejemplo, cerca de la tina de baño, lavabo, sótano mojado o cerca de una alberca, etc.
- 6 El aparato eléctrico debe ser usado únicamente con carritos o pedestales que sean recomendados por el fabricante.
- 7 El aparato eléctrico debe ser montado a la pared o al techo sólo como sea recomendado por el fabricante.
- 8 Servicio—El usuario no debe intentar dar servicio al equipo eléctrico más allá a lo descrito en las instrucciones de operación. Todo otro servicio deberá ser referido a personal de servicio calificado.
- 9 El aparato eléctrico debe ser situado de tal manera que su posición no interfiera su uso. La colocación del aparato eléctrico sobre una cama, sofá, alfombra o superficie similar puede bloquea la ventilación, no se debe colocar en libreros o gabinetes que impidan el flujo de aire por los orificios de ventilación.
- 10 El equipo eléctrico deber ser situado fuera del alcance de fuentes de calor como radiadores, registros de calor, estufas u otros aparatos (incluyendo amplificadores) que producen calor.
- 11 El aparato eléctrico deberá ser conectado a una fuente de poder sólo del tipo descrito en el instructivo de operación, o como se indique en el aparato.
- 12 Precaución debe ser tomada de tal manera que la tierra física y la polarización del equipo no sea eliminada.
- 13 Los cables de la fuente de poder deben ser guiados de tal manera que no sean pisados ni pellizcados por objetos colocados sobre o contra ellos, poniendo particular atención a los contactos y receptáculos donde salen del aparato.
- 14 El equipo eléctrico debe ser limpiado únicamente de acuerdo a las recomendaciones del fabricante.
- 15 En caso de existir, una antena externa deberá ser localizada lejos de las líneas de energía.
- 16 El cable de corriente deberá ser desconectado del cuando el equipo no sea usado por un largo periodo de tiempo.
- 17 Cuidado debe ser tomado de tal manera que objetos líquidos no sean derramados sobre la cubierta u orificios de ventilación.
- 18 Servicio por personal calificado deberá ser provisto cuando:
 - A: El cable de poder o el contacto ha sido dañado; u
 - B: Objetos han caído o líquido ha sido derramado dentro del aparato; o
 - C: El aparato ha sido expuesto a la lluvia; o
 - D: El aparato parece no operar normalmente o muestra un cambio en su desempeño; o
 - E: El aparato ha sido tirado o su cubierta ha sido dañada.

INSTALLATION

CONFIGURATION

OPERATION

FURTHER INFORMATION

INDEX



© 2010 Black Box Corporation
All trademarks are acknowledged.

Black Box Corporation,
1000 Park Drive,
Lawrence,
PA 15055-1018,
United States of America
Tel: +1-724-746-5500
Fax: +1-724-746-0746

- INSTALLATION
- CONFIGURATION
- OPERATION
- FURTHER INFORMATION**
- INDEX

Index



A

Access
 local and remote users 32
Access control
 configuration 66
 mask calculation 80
Access mode
 shared & private 42
Account
 creation for users 61
Address
 explanation 78
Addressing
 cascaded computers 84
 DNS 27
 network issues 26
 power switch boxes 14
ADMIN
 forgotten password 21
 password 20
Admin password
 initial setup 18
 local setting 56
Advanced options 55
Advanced unit configuration
 63
Artifacts
 on screen 40
Assistance
 Black Box subsidiaries 95
Auto calibrate 42
Autoscanning 21
Auto select 71,77

B

Baud rate
 local setting 58
 remote setting 67
Binary
 net masks 79
Brackets 7
 fitting 8
Browser
 connection 39
 viewer options 77

C

Cable specifications 82,85
Calibrate
 mouse 42
 screen 42
Calibrate all
 video settings 45
Cascade connections
 addressing 84
 introduction 5,82
 tips for success 83
Clear IP access control
 local setting 57
Colour level 71
Computer
 connection 12
 ports 6
 selecting 32
Computer Access Module
 connection 12

Configuration 17
 initial IP 23
 menus 19,50
 overall steps 17
 pages 20,60
 saving and restoring 21
Confirmation box 35
Connections 9
 Computer Access Module 12
 computer system 12
 global user 12
 host computer 10
 keyboard 10
 local user 10
 multiple video head 15
 network port 11
 power control 14
 power supply 13
Connector specifications 85
Control menus 40
Controls
 viewer options 43
Control strings
 power switching 29

D

Daisy chain cable 85
Date
 local setting 56
DHCP
 discovering allocations 27
 during initial setup 18
 remote setting 65
DNS addressing 27

E

Encryption key 18
Encryption settings 24
 viewer 48
End user licence 89

F

Firewall 26
Firmware
 current version 62
 recovery procedure 30
 upgrade 30
Force encryption 56
Front panel
 controls and indicators 31
Full screen mode
 escape from (F8) 40
Functions 51,55

G

Gateway
 local setting 57
 remote setting 65
Global preferences 53,55
Global user
 access 37
 connection 12

H

Hextile 71,77
Host computer
 changing between 40,41
 configuration 68
 connecting 10
 connection 12
 power switching setup 29
 selection 41

Hotkeys
 changing 20
 codes and macros 86
 selecting computers 32,47
 VNC or browser viewer 47
HTTP port
 initial setup 18
 local setting 57
 remote setting 65
 when altered 26

I

Identities
 VNC Viewer 75
Indicators 6,31
Initial configuration 17
IP access control 65,66
 calculating mask 80
 clearing 22
IP address
 local setting 57
 remote setting 65
IP gateway 65
IP network mask 65
IP port
 configuration via viewer 23
 connecting 11

K

Keyboard codes
 sending 44
Keyboard layout
 local setting 56
 remote setting 62

INSTALLATION

CONFIGURATION

OPERATION

FURTHER INFORMATION

INDEX

L

- Local connection 32
- Local network
 - connection 25
- Local user
 - connection 10
 - port 6
- Logging 69
- Logging in and out
 - section 34,35
- Log on 38

M

- MAC address 57,64,65
- Mask
 - explanation 78
 - for IP access control 80
- Menu bar
 - viewer window 40
- Menu key
 - changing 72
- Mounting 8
- Mouse
 - calibration 42
 - control 43
 - pointers 41
 - resync 42,43
- Multiple video head
 - connections 15

N

- Net mask 57
 - explanation 78
- Network configuration 57,65
- Networking issues 25
- Network port
 - connection 11

O

- Octets
 - IP address 78
- Operation 31
- Options port
 - baud rate 67
 - configuration 58
- Orange dot
 - in Select Host menu 36

P

- Parts
 - supplied and extra 7
- Password
 - admin 20
 - admin - setting 56
 - forgotten 21
 - initial setup 18
 - remote logon 38
 - setting for users 61
- Port number
 - entering 48
- Power control
 - connection 14
- Power strings
 - for switching 29
- Power supply
 - connecting 13
- Power switching
 - addressing 14
 - configuration 29
 - connection 14
 - control sequences 29
 - on & off select 42
 - user permissions 61
 - via viewer 42
- Preferred encoding 71
- Private
 - access mode 42

R

- Rack mounting 8
- Raw 71,77
- Recover
 - upgrade failure 30
- Refresh screen 43
- Remote configuration
 - advanced unit configuration 63
 - host configuration 68
 - logging and status 69
 - network configuration 65
 - serial port configuration 67
 - setting IP access control 66
 - unit configuration 62
 - user accounts 61
- Reset configuration 59
- Resync mouse 43
- RJ9 connector 14
- Router 26
- Routing status 35

S

- Safety information 88
- SAM
 - connection 12
- Saving
 - configuration settings 21
- Scaling
 - VNC Viewer 74
- Screen
 - best resolution 40
 - calibration 42
 - navigation 40
 - refresh 43
- Screensaver
 - local setting 56
- Security
 - enabling 20
 - ensuring 28
 - general steps 20

- Selecting
 - cascaded computers 35
 - computers 32
 - with hotkeys 32,47
 - with mouse buttons 34
 - with on-screen menu 33
- Serial port
 - configuration 67
- Server
 - configuration 68
- Server IP
 - local setting 58
- Setup options 51,54
- Shared
 - access mode 42
- Show All Users
 - local user 34,51
 - VNC or browser viewer 46
- Single mouse mode 41,43
- Slow connections
 - optimizing for 40
- Supplied items 7
- Syslog 69,70

T

- Threshold
 - adjustment 45
- Time
 - local setting 56
- Time & date configuration 64
- Troubleshooting 49

U

- Unit Configuration 56,62
- Unit name
 - local setting 56
 - remote setting 62
- Upgrade
 - firmware 30
 - recover after failure 30
- Use DHCP
 - local setting 57
- User accounts 61
- User preferences 52,54

V

- Video modes 87
- Video settings 43
- Viewer window 40
- VNC port
 - initial setup 18
 - local setting 57
 - remote setting 65
 - when altered 26
- VNC viewer
 - connection 38
 - connection options 71
 - download 38
 - window options 76

W

- Warranty 88
- Web browser
 - connection 39
 - viewer options 77

Z

- ZRLE 71,77



BlackBox subsidiary contact details



Country	Web Site/Email	Phone	Fax
United States	www.blackbox.com	724-746-5500	724-746-0746
Austria	www.black-box.at support@black-box.at	+43 1 256 98 56	+43 1 256 98 56
Belgium	www.blackbox.be support.nederlands@blackbox.be support.french@blackbox.be support.english@blackbox.be	+32 2 725 85 50	+32 2 725 92 12
Denmark	www.blackbox.dk support@blackbox.dk	+45 56 63 30 10	+45 56 65 08 05
Finland	www.blackbox.fi tuki@blackbox.fi	+35 201 888 800	+35 201 888 808
France	www.blackbox.fr tech@blackbox.fr	+33 1 45 606 717	+33 1 45 606 747
Germany	www.black-box.de techsupp@black-box.de	+49 811 5541 110	+49 811 5541 499
Italy	www.blackbox.it supporto.tecnico@blackbox.it	+39 02 27 404 700	+39 02 27 400 219
Netherlands	www.blackbox.nl techsupport@blackbox.nl	+31 30 241 7799	+31 30 241 4746
Norway	www.blackboxnorge.no support@blackboxnorge.no	+47 55 300 710	+47 55 300 701
Spain	www.blackbox.es tecnico@blackbox.es	+34 9162590732	+34 916239784
Sweden	www.blackboxab.se support@blackboxab.se	+46 8 44 55 890	+46 08 38 04 30
Switzerland	www.black-box.ch support@black-box.ch	+41 55 451 70 71	+41 55 451 70 75
UK	www.blackbox.co.uk techhelp@blackbox.co.uk	+44 118 965 6000	+44 118 965 6001
Ireland	www.blackbox.co.uk techhelp@blackbox.co.uk	+353 1 662 2466	+353 1 662 2477

INSTALLATION

CONFIGURATION

OPERATION

FURTHER
INFORMATION

INDEX