

MODULAR UNIT

Wireless Ethernet Bridge

System User Guide

Version 2

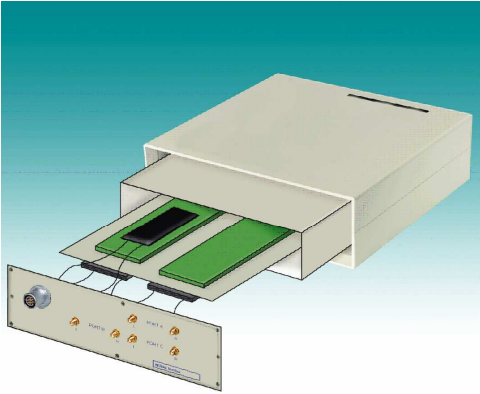
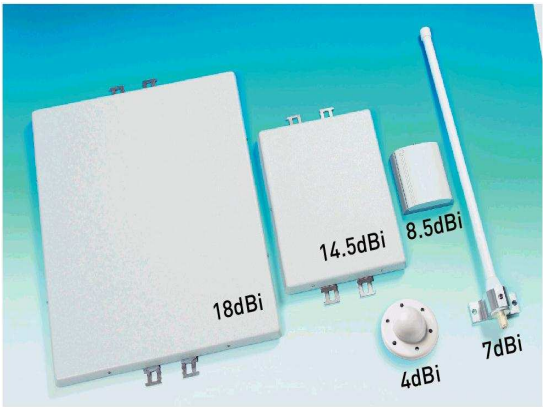

Copyright © 2004 by Black Box Network Services. All rights reserved. No part of the contents of this document may be reproduced or transmitted in any form or by any means without the written permission of the publisher.

This Installation Guide is designed to be used when installing the MODULAR UNIT Wireless Ethernet Bridge and any of the outdoor antennas range available for creating network connections between buildings using wireless local area network, WLAN, based technology, MODULAR UNIT Wireless Ethernet Bridge. Only the MODULAR UNIT Wireless Ethernet Bridge and antenna installation process is detailed herein and further documentation may be required to create the complete network installation.

Associated Documentation

To complete a network connection between buildings using a WLAN solution requires knowledge of the installation process for not only the radio unit and antenna, but the switch/bridge/router used for connection to the existing network infrastructure.

Black Box Network Services welcomes feedback and any suggestions for improvements or changes to this user guide would be greatly appreciated. All comments can be directed to aforementioned addresses.

Note:

This use guide provides best practices for the use, installation and operation the MODULAR UNIT Wireless Ethernet Bridge and associated antennas. Failure to follow these instructions may result in non-operation of the MODULAR UNIT Wireless Ethernet Bridge, or, poor performance of the system.

Where MODULAR UNIT is operating with 11Mbit/s 2.4GHz Radios, MODULAR UNIT units can not only communicate with other MODULAR UNIT units, but is also compatible with Black Box Network Services' FARST WIRELESS ETHERNET BRIDGE Wireless Ethernet Bridge product. For this reason, when referring to network connectivity the term FARST WIRELESS ETHERNET BRIDGE is sometimes referred to in addition to the name MODULAR UNIT.

Particular attention must be placed to the accuracy of site surveys.

Black Box Network Services accepts no responsibility for the accuracy of site surveys conducted by anyone other than Black Box Network Services personnel. Black Box Network Services accepts no responsibility for damage, non-operation or poor operation of any equipment supplied that has been configured, installed or operated in any manner not addressed within this user guide.

WARNING

Please note the following before handling the Modular Unit Wireless Ethernet Bridge Product

- The Modular Unit Wireless Ethernet Bridge does not have a power on/off switch. When connecting the AC power cord to a suitable AC outlet, the Modular Unit powers up immediately
- Removal of the power cord is the only way to turn off the Modular Unit Wireless Ethernet Bridge. The power cord must always be connected in a location that can be accessed quickly and safely in case of an emergency.
- Do not apply power to Modular Unit Wireless Ethernet Bridge without the appropriate antennas connected to the antenna ports. Failure to do so may result in permanent damage to the RF power amplifier, which is not covered by warranty.
- The Modular Unit Ethernet Radio Bridge and its associated antennas are intended for mounting on a flat roof, or the side of a building. Installation shall not be attempted by someone who is not trained or experienced in this type of work. The Modular Unit Wireless Ethernet Bridge and antenna has to be installed by a suitably trained professional installation technician or a qualified antenna installation company. The site pre-requisites have to be checked by a person familiar with the national electrical code, and other regulations governing this type of installation.
- This equipment is in conformity with the essential requirements of directive 1999/519/EC. The use of the warning symbol means that the equipment is subject to restrictions of use in certain countries.



- The Modular Unit Wireless Ethernet Bridge is intended for use in all EU and EFTA countries except France and Spain. It does not require a radio license when used in accordance with these instructions.
- The Modular Unit Wireless Ethernet Bridge is also intended for use in the USA. This device complies with part 15 of the FCC Rules. Operation is subject to the following two conditions:
 - (1) The Modular Unit Wireless Ethernet Bridge may not cause harmful interference.
 - (2) The Modular Unit Wireless Ethernet Bridge must accept any interference received, including interference that may cause undesired operation.

TABLE OF CONTENTS`

1 INTRODUCTION	5
2 EXTERNAL CONNECTIONS TO MODULAR UNIT™	6
3 SYSTEM SET-UP AND OPERATION	7
3.1 LED OPERATION	9
3.1.1 Normal Mode – Data Indicators.....	10
4 INSTALLATION TESTING	11
5 RADIO COVERAGE.....	12
5.1 GENERAL ADVICE.....	12
5.2 ANTENNA CONNECTION.....	12
5.2.1 Antenna Ports	13
6 SYSTEM SOFTWARE CONFIGURATION.....	14
7 FREQUENCY CHANNELS FOR 2.4GHZ RADIOS.....	22
8 SITE SURVEY REQUIREMENTS	23
8.1 OVERVIEW	23
8.2 INSTALLATION PRE-REQUISITE CHECK LIST	23
8.3 LINE OF SIGHT REQUIREMENTS	25
8.3.1 Radio Barriers	25
8.3.2 Fresnel Zone	26
8.4 ANTENNA MAST MOUNTING AND CABLE LENGTH REQUIREMENTS	27
9 INSTALLING ANTENNAS.....	28
9.1 OVERVIEW	28
9.2 SUPPORT STRUCTURES FOR THE ANTENNA	30
9.3 LINE OF SIGHT ADJUSTMENT	32
9.4 PROVIDING A WEATHERPROOF INSTALLATION.....	33
9.5 EARTH GROUNDING OF ANTENNA	34
10. SPECIFICATION.....	35
11 ACCESSORIES	36
12 SNMP IMPLEMENTATION.....	37
13 GLOSSARY	40
14 MODULE DIMENSIONS AND FIXINGS.....	41
15 TROUBLESHOOTING	42

1 INTRODUCTION

This use guide describes the set-up and operation of the MODULAR UNIT Wireless Ethernet Bridge and its associated components.

Also included in this use guide are chapters focusing on the site survey and what to consider before and during installation of the radio system. MODULAR UNIT is a radio modular architecture that is designed to support a number of different radio modules. The basic radio module is the 2.4 GHz 11Mbit/s radio details of which are described in this manual. Details of other radio designs are detailed in separate documentation that accompanies the radio modules.

2.4GHz 11Mbit/s radios operate in the 2.4 GHz licence-free ISM band and provide data links between data networks at on-air data rates up to 9 Mbit/s, the reduction in throughput is attributed to system overheads.

The use of the MODULAR UNIT Wireless Ethernet Bridge and its associated antennas are designed for external use. The design of the system has taken due consideration of RF exposure and should always be installed by trained professionals who will not place the MODULAR UNIT Wireless Ethernet Bridge in an environment where RF energy may be considered harmful. The MODULAR UNIT Wireless Ethernet Bridge will at no time during operation provide Effective Isotropic Radiated Power (EIRP) of greater than the regulatory stipulation for the country of operation. In the 2.4GHz ISM band this maximum is 100mW (0.1 W) (European Council Recommendation 1999/519/EC) for European models and 1W for North American versions (Part 15 FCC Rules).

Figure 1.01 shows how the MODULAR UNIT Wireless Ethernet Bridge may be used to provide a wireless connection from a remote PC to a wired LAN.

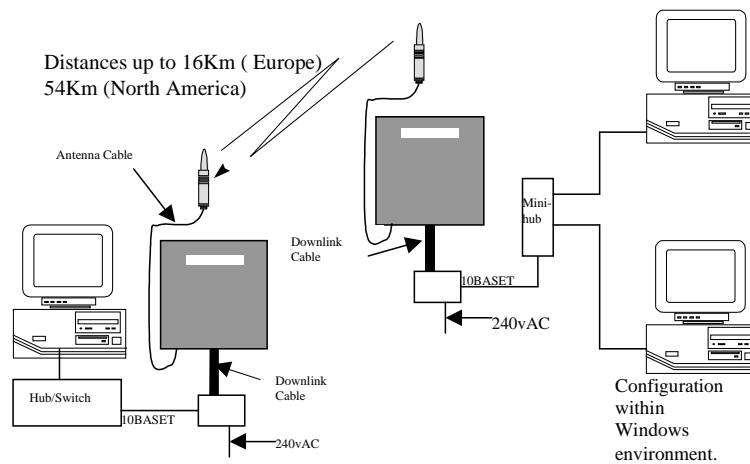

Figure 1.01: Example showing how two radio bridges may be used in a network

The radios are configured at the factory with default settings prior to dispatch. Parameters such as frequency channel, modulation waveform, and antenna diversity can be set up using the system configuration utility.

The rest of this document describes benchmark testing, radio coverage, and MODULAR UNIT Wireless Ethernet Bridge specification. The appendices provide system configuration, frequency channels, dimensions and fixings and antenna installation and fitting.

2 EXTERNAL CONNECTIONS TO MODULAR UNIT™

The MODULAR UNIT Wireless Ethernet Bridge utilises a low profile self-latching multi way connector for quick, easy and secure connection with the 'Downlink' cable as shown schematically in figure 2.01. The 'Downlink' cable supplies dc power and Ethernet data to the MODULAR UNIT Wireless Ethernet Bridge. The cable has two identical ends; one connects to the radio unit and the other to the 'break-out' box. This box has two further connections to 240vAC power and RJ45 for Ethernet connection to a Hub, Switch or Router.

The 'Break-out' box must be kept away from external weathering. Connection to an AC power source is via an IEC power cable (supplied) with input power range of 90 to 240vAC. The power output from the 'break-out' box to the MODULAR UNIT Wireless Ethernet Bridge is 24vDC.

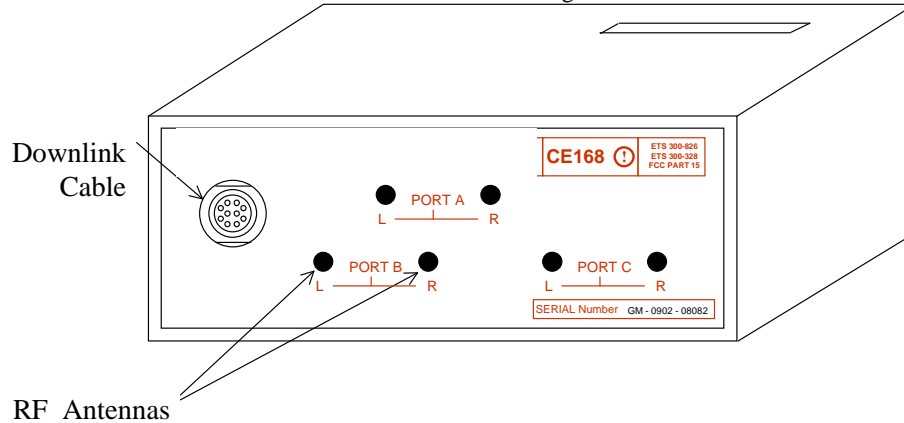

Figure 2.01: Schematic representation of Modular Unit Wireless Ethernet Bridge

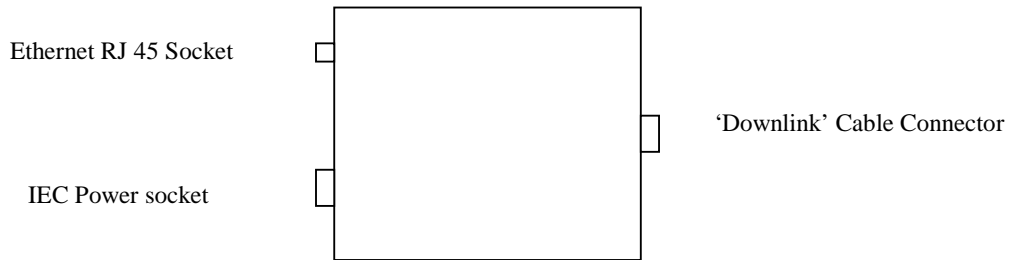
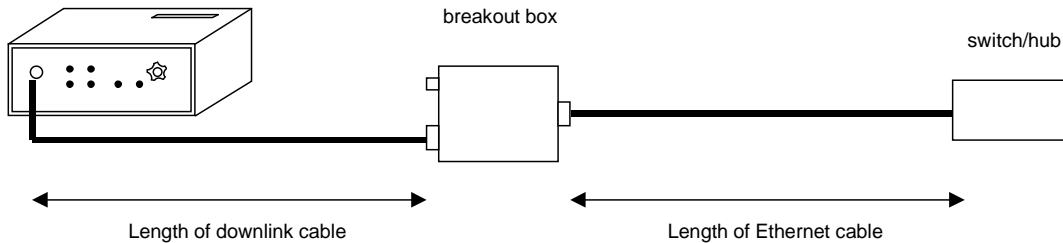

Figure 2.02: Schematic representation of 'Break-out' box

Remember Ethernet rules apply so Radio units must be no more than 90metres from the nearest Hub or Switch. Total distance is the length of Downlink cable (between MODULAR UNIT and 'breakout box') plus the length of the Ethernet CAT5 cable (between the 'breakout box' and the Hub or Switch).



Length of downlink cable + Length of Ethernet Cable < 90 metre

Figure 2.03: Maximum cable lengths

3 System Set-up and Operation

System operation from initial set up has been made as simple as possible. The MODULAR UNIT Wireless Ethernet Bridge has a number of components:

- MODULAR UNIT Wireless Ethernet Bridge Radio unit.
- Break-out Box
- Downlink Cable
- Antenna Cable
- IEC Power Cable
- Antenna

The first decision, which would have been made at the time of site-survey, is to establish how and where the MODULAR UNIT Wireless Ethernet Bridge and antenna(s) are to be situated.

In Figure 3.01 below, we show the back view of the MODULAR UNIT Wireless Ethernet Bridge radio unit with its screw mounting. A template can be supplied with the unit for wall screw fixings. Please select the correct type of screw and fixing appropriate to the material used in the wall or surface construction.

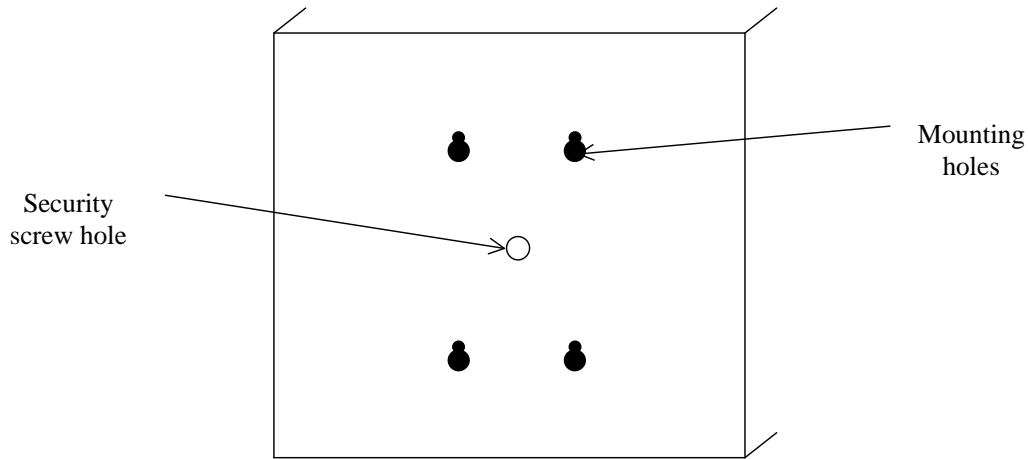

Figure 3.01 MODULAR UNIT Back plate with screw fixing holes

If the mounting of the MODULAR UNIT Wireless Ethernet Bridge is to a pole, then a pole mounting plate is available as an option. This plate extends above and below the height of the MODULAR UNIT Wireless Ethernet Bridge to allow the use of circlips or 2" U bolts for connection to a pole. The holes can also be used for screw fixing without a template. Figure 3.02 describes this in further detail.

Note that the use of an M5 security screw in the centre of the unit is optional. If fitted the unit should be secured to the mounting plate prior to fitting the mounting plate to the wall or pole. If applied the unit will be unable to be easily removed from the back plane and will require the removal of the back plane from its mounting in order to remove the unit. If the security screw is not fitted, the unit may be easily removed from the mounting plate without having to remove the mounting plate from the wall.

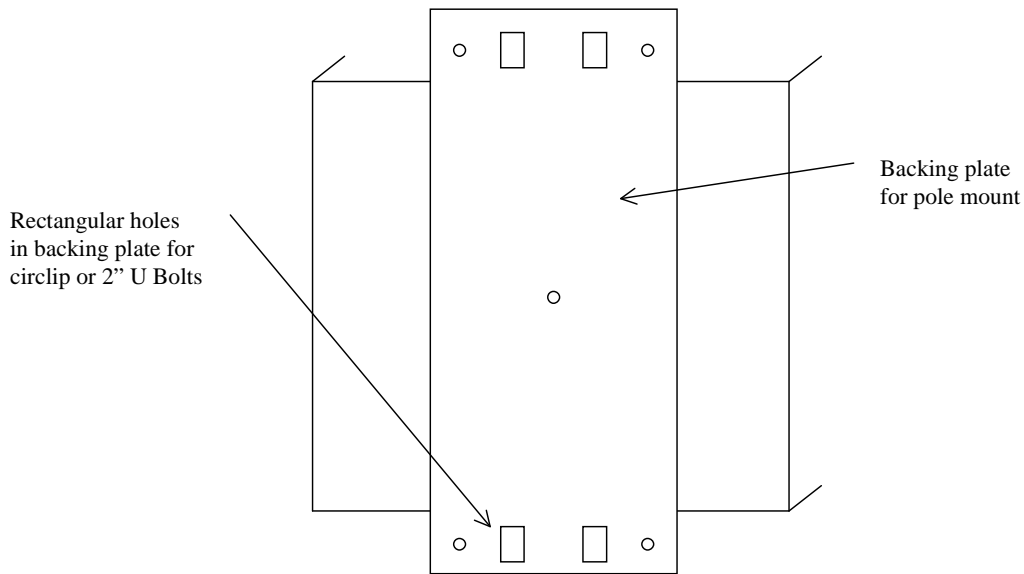

Figure 3.02 Pole mounting Backing Plate

Once the radio unit is connected to a wall or pole, the next step is to connect the antenna(s). If the MODULAR UNIT is fitted with a single radio capability, Port A should be used. If a single antenna is used, then the Left antenna connector of the port will be configured. Please refer to the front panel legend, or figure 2.1 for the orientation of antenna ports. The antenna must be connected to the MODULAR UNIT Wireless Ethernet Bridge unit by means of the antenna cable supplied by Black Box Network Services. Use of any other cable may invalidate the European approvals for the use of 2.4GHz radio. The connections on both the antenna and the radio unit are of type SMA. Hand tightening is only required. **DO NOT OVERTIGHTEN.**

Do not apply dc power to modules without the appropriate antennas connected to the antenna ports. Failure to do so may result in permanent damage to the RF power amplifier, which is not covered by warranty.

The Downlink cable can now be fitted to the MODULAR UNIT Wireless Ethernet Bridge. This is fitted by aligning the 'red' dot on both the barrel and the socket which is then a self-locking push fit. To release pull back on the barrel, (cable end) and the Downlink cable will release from the radio.

Run the Downlink cable to an internal position, which can be maintained in a dry atmosphere. Connect the Downlink cable to the Break-out box in a similar way as that taken with the radio end. The Break-out box can now be connected to an AC power source using the IEC cable supplied. The MODULAR UNIT Wireless Ethernet Bridge will now be powered and will self boot its operational software. Connect a CAT5 patch cable to a local Switch, Hub or Router.

This procedure must be followed for each MODULAR UNIT Wireless Ethernet Bridge that is being installed as part of a point to point or multiple point links.

BLACK BOX NETWORK SERVICES supply a 'Downlink' cable combining Ethernet CAT 5 with 24vdc-power connector. This cable is available in lengths up to 90m in length. Modifications to this cable should not be undertaken other than by BLACK BOX NETWORK SERVICES engineers. Lengths in excess of 90m may result in voltage loss sufficient not to power the radio and cause data loss or corruption.

3.1 LED Operation

The MODULAR UNIT Wireless Ethernet Bridge front panel display consists of a panel of 8 bi-colour LED's plus two bi-colour LED's for the Ethernet Chip.

There are three radio interfaces, there are two for each radio port and the final two to act as an error indicator. Tri-colour because each is capable of displaying green only, red only, or both colours which provides an amber colour.

Figure 3.03 shows the position of each of the 8 LEDs, from left to right there is a group of two LEDs followed by a group of eight.

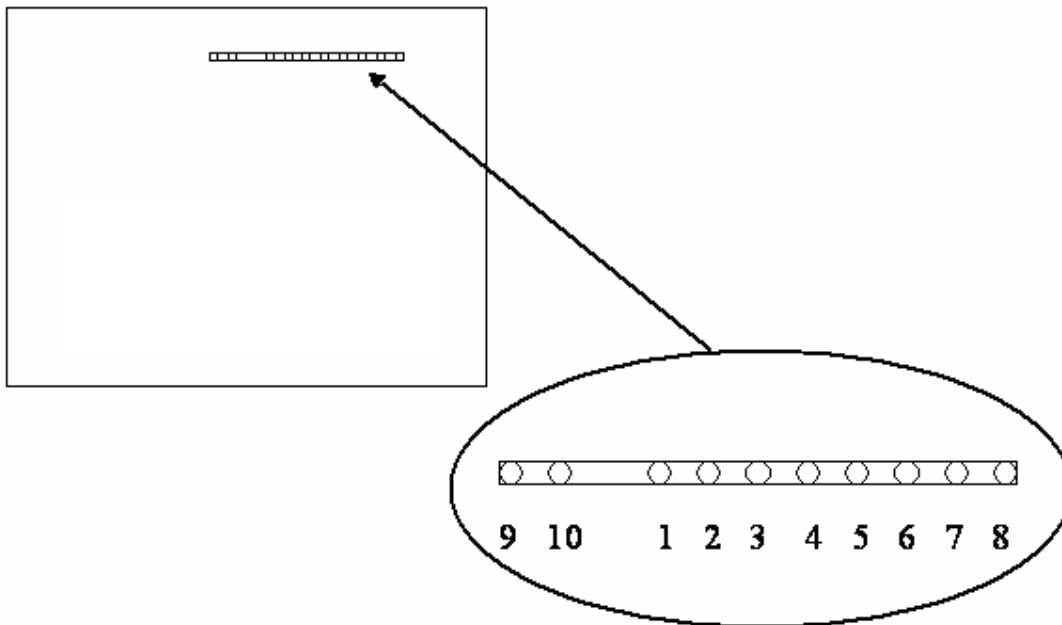

Figure 3.03 LED Display

3.1.1 Normal Mode – Data Indicators

The meanings attached to the LEDs are as follows:

1, 3 & 5: Link Quality Radio Port A, B & C

When Status LED unlit:

Off - Radio Port not yet configured
Red - Satellite looking for a partner
Orange - Base looking for a partner
Green - Logon process occurring

When Status LED lit:

Off - <80%
Red – 80 to 95%
Orange – 95.01 to 99%
Green - 99.01 to 100%

The above meanings are fixed regardless of LED Mode.

2, 4 & 6: Status of Radio Port A, B & C

Off - No link, quality LED shows status
Red - No Radio Rx, link may go down
Orange - Radio Rx, link is up
Green - Radio Rx with data. Link is up and Ethernet data is being transferred.

7 & 8: Up to 7 Error Codes, Green and Green means unit is OK. The unit will manipulate these LEDs to OK when boot up is complete and the main code is starting up. Error codes are TBD

9: Green – Ethernet connected at 100 BaseT
Dim Red – Ethernet connected at 10 BaseT

10: Green (pulsed) – Ethernet packet received
Red (pulsed) – Ethernet packet transmitted

4 INSTALLATION TESTING

All MODULAR UNIT Wireless Ethernet Bridge are tested prior to leaving the factory. However, if performance falls short of expectation after installation (e.g. low network throughput), it is usually for one or more of the following reasons:

- Poor network performance
- Poor siting of antennas
- Wrong choice of antennas
- Inappropriate antenna cabling
- Excessive cable runs (power and data)¹

Although there can be several installation pitfalls, a common problem occurs when a radio link is added to an already congested data network. An IT Manager may observe poor data throughput when comparing with a cabled link shows the bottleneck is the network itself!

Therefore a useful test entails linking at least two PCs together as indicated in figure 4.01.

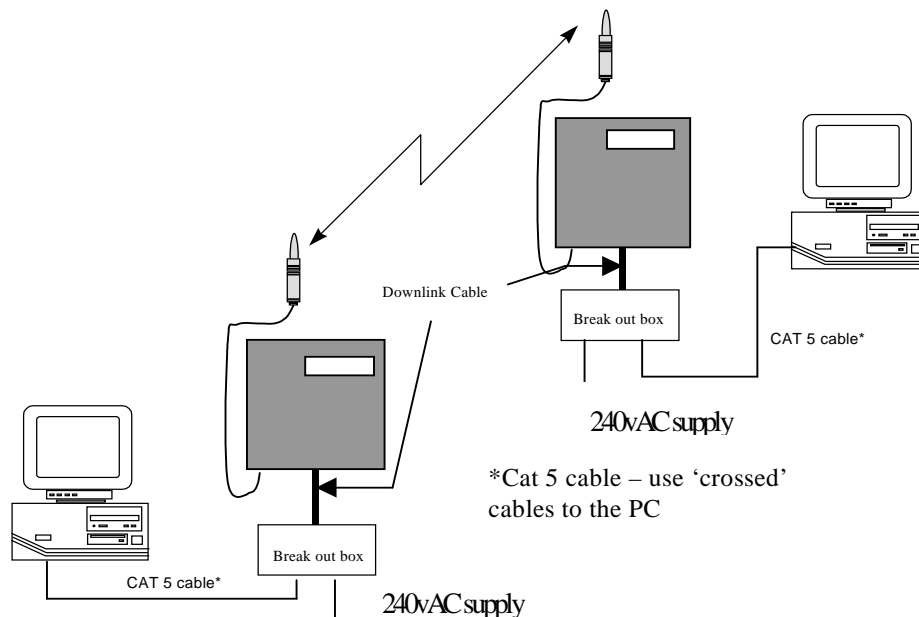

Figure 4.01: Benchmark test set-up

Provided that the PCs contain suitable network cards, the measured data capacity for an FTP transfer across the fade-free radio link **should exceed** 8 Mbit/s throughput with an 11 Mbit/s radio. It is essential to use PCs and software packages capable of “exercising” the radios to the required level.

The link diagnostics section of RF Analyser will also provide information about the link data throughput.

¹ **BLACK BOX NETWORK SERVICES** supply a ‘Downlink’ cable combining Ethernet CAT 5 with 12vdc-power connector. This cable is available in lengths up to 90m in length. Modifications to this cable should not be undertaken other than by **BLACK BOX NETWORK SERVICES** engineers. Lengths in excess of 90m may result in voltage loss sufficient not to power the radio and cause data loss or corruption.

5 RADIO COVERAGE

5.1 General Advice

It is advisable to plan out the radio installation before committing hardware to specific locations. Line-of-sight between radios that cross solid brick or concrete walls should be avoided as these materials attenuate the radio waves at 2.4 GHz strongly. Check to see if alternative routes exist that do not intersect the walls. Always arrange a site survey before installation, this will enable measurements to be made that will determine how far signals can propagate between the buildings and highlight the problem areas, e.g. where walls and other structures create shadowing effects.

If a data-to-radio link point is located in a difficult area, it may be possible to relocate the radio unit by extending the cable connecting to the data port. Extending the antenna cables is not generally useful because the longer antenna cables will attenuate the radio frequency signals.

The distance of the antenna from any conducting (e.g. metallic) surface should be at least one wavelength, which at the 2.4GHz frequency of operation is approximately 125 mm. The antenna beam pattern will be increasingly distorted if the distance is reduced to 62 mm and reduction in range may result. Serious loss of performance will occur if the distance is below 62 mm. For mountings against non-conducting surfaces, distortions may be less severe, but it is good practice to observe the same distance rules.

5.2 Antenna Connection

The Radio modules comprise two antenna ports to allow extended range operation (i.e. dedicated transmit on a low gain antenna, and dedicated receive on a high gain antenna). However, the radios can be configured in a number of transmit and receive combinations of the antenna ports left 'L' and right 'R' as shown in figure 5.01. **Option 4 is the factory default.**

Option	Left 'L'	Right 'R'
1	Tx/Rx	Rx
2	Rx	Tx/Rx
3	Tx/Rx	Tx/Rx
4	Tx/Rx	-
5	-	Tx/Rx

Table 5.01: Antenna options



Do not apply dc power to modules without the appropriate antennas connected to the antenna ports. Failure to do so may result in permanent damage to the RF power amplifier, which is not covered by warranty.

5.2.1 Antenna Ports

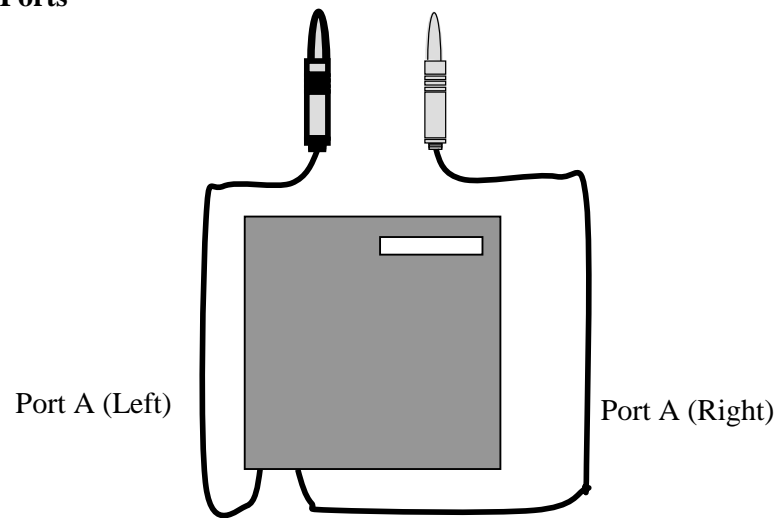

Figure 5.02: Antenna ports A and B

In table 5.01 **Option 1** provides transmit on Port A (Left) and receive on either ports A or B. This is useful in a multi-path fading environment where the receiver decides automatically which antenna is used to receive the incoming data packet. The selection is performed on a packet-by-packet basis. **Option 3** involves transmitting data via the “better” antenna, assuming this port was used to receive the previous incoming data packet off-air. Antenna port options are selected using the set-up menus. The instructions must be carefully followed. It is usual for these options to be specified by the customer beforehand.

6 System Software Configuration

MODULAR UNIT Wireless Ethernet Bridges can be configured using the RF Analyser software tool. RF Analyser incorporates a multiple level password entry system to enable the configuration of any MODULAR UNIT Wireless Ethernet Bridge to different degrees. Each level enables a different set of characteristics to be manipulated.

For low level configuration, RF Analyser requires an Installer ID which can be provided from Black Box Network Services Technical Support. However Black Box Network Services will only issue 'low-level' passwords to fully trained engineers. Installation engineers will need to attend the appropriate training course to gain the skills required to handle the lower password sequences.

A MODULAR UNIT radio system can be operated in either Point to Point (P_P), or Point to Multi-Point (P-MP) mode. In the case of P-MP the base can support between one and sixteen satellites.

The configuration software operates within a Windows XP, 2000, 98, 95 or NT environment.

RF Analyser Home Screen

The following illustrations are based on RF Analyser ver 3.0.1. Figure 6.01 is the opening screen for the 'RF Analyser' configuration program, after a valid Installer ID has been entered.

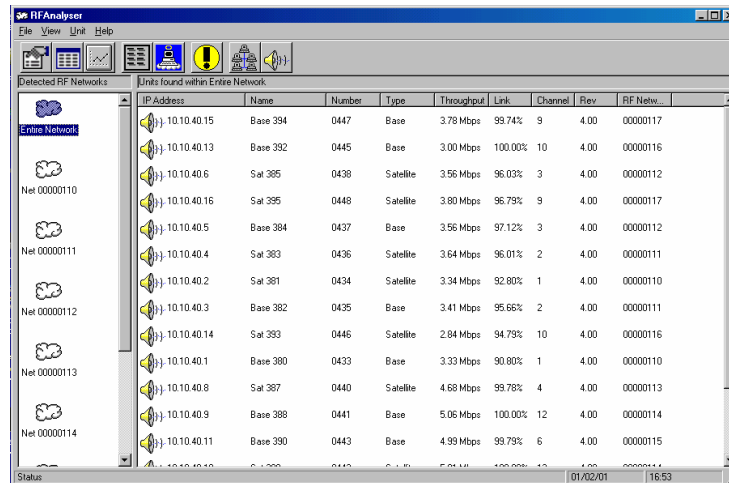

Figure 6.01: RF Analyser Home Page

The 'RF Analyser' opening screen is divided into two frames: a left hand frame and a right hand frame. The left-hand frame defines the different RF networks that have been found. The default presentation in the left-hand frame is the 'entire network'. An RF network is defined as the group of MODULAR UNIT or FARST WIRELESS ETHERNET BRIDGE Wireless Ethernet Bridges that share a common RF Network ID. When 'Entire Network' symbol is selected within the left-hand frame, it shows all MODULAR UNIT or FARST WIRELESS ETHERNET BRIDGE Wireless Ethernet Bridges found within the network. In the right-hand frame the 'scanning' process will look across an entire organisations network as far as the router(s). The scanning process will not detect MODULAR UNIT or FARST WIRELESS ETHERNET BRIDGE Wireless Ethernet Bridges that are beyond a routing device. Once devices have been selected, a line of information is dynamically updated on the screen. This information provides Unit Name, Unit Number, Unit Type, Throughput and Link Quality.

Unit Name – A unique name that can be allocated to each of the MODULAR UNIT Wireless Ethernet Bridges.

Unit Number – This is a factory setting which is unique. **This cannot be changed.**

Unit Type – This identifies what type of unit – either a Base or Satellite station.

Throughput – Measured in Millions bits per second.

Link Quality – An indicator that defines the overall quality of the link. This should be as close to 100% as is possible. **Please see the RF Analyser help tab.**

RF Analyser Unit Selection

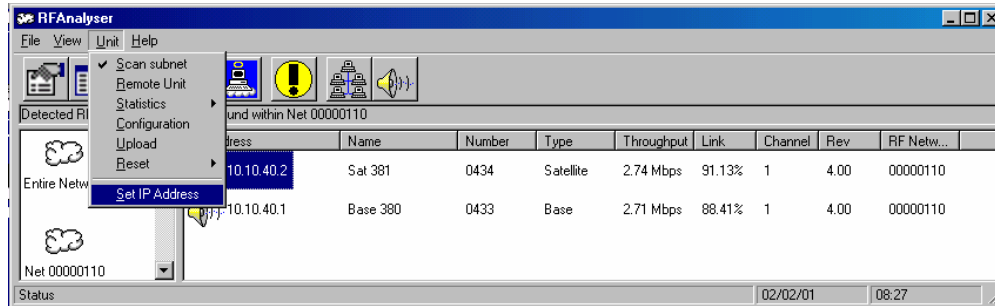

Figure 6.02

To select an individual MODULAR UNIT Wireless Ethernet Bridge radio, either right mouse click on the selected radio or select the radio and then select the 'Unit' tab on the top bar. Once selected the choice options are defined in figure 6.02.

The options are;

Statistics – Detailed analysis of the status of the selected unit.

Reset – *Soft*, the unit will re-initialise and continue without logging out from the network. *Hard*, will re-boot the unit and will log out from the network. Upon starting from a hard reset, the unit will search for the network to log in.

Set IP Address – If the configuration of a Modular Unit is not known, then by use of the serial number, an IP address can be set which enable a PC to communicate with the Fast Wireless Ethernet Bridge. Full configuration can follow.

By selecting the 'File' tab and then selecting **enhanced mode**, entering password the following options will become available;

Scan Subnet – When 'ticked' will automatically scan for all and any MODULAR UNIT Wireless Ethernet Bridges present within the subnet address entered. These will be beyond any routing devices. Normal scanning will only search as far as routers.

Remote Unit - enter the IP address of a single Modular Unit that does not appear within own local network. I.e. on the other side of a router.

Configuration – The ability to change certain operating conditions of the selected unit. Remember to 'save' the changes before moving to another function.

Upload – The ability to upload a new version of software. This will be used for new Version upgrades. See figure 6.06

In the following example unit statistics is selected to view. There then is a choice between '**Raw Statistics**' and '**Graphs**'. These provide different ways at viewing the function of the MODULAR UNIT Wireless Ethernet Bridge.

Statistics

Select '**Raw Statistics**' the following screen can be seen:

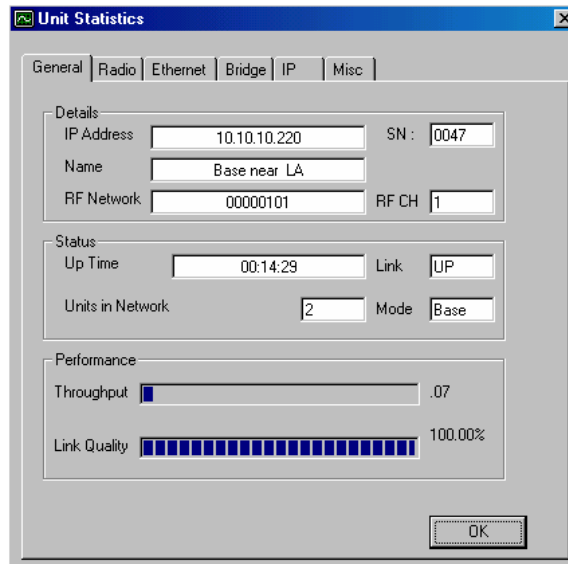

Figure 6.03

Figure 6.03 shows details about the selected radio and its status. This is the presentation under the '**General**' tab. At the bottom of the box, data throughput and link quality are shown as dynamic bars. The numerical value for each bar at any moment in time is indicated to the right hand side of the dynamic bar.

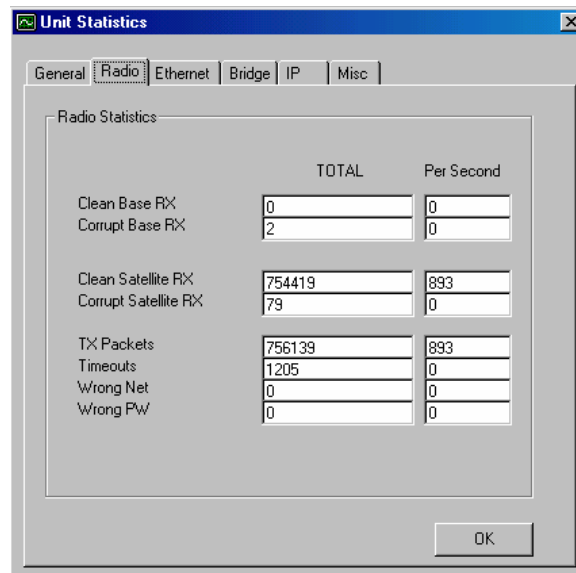

Figure 6.04

Select the '**Radio**' tab: The screen as depicted in figure 6.04 shows the current statistics as measured from the radio. It provides an indication as to the overall operation of the radio.

If there are a large number of errors in the '**wrong net**' box this is a good indication that another set of MODULAR UNIT Wireless Ethernet Bridges are operating in close proximity with the same RF channel set. This can be modified and corrected by use of the unit configuration

Other unit statistics, figure 6.05, this time are viewed from the **Ethernet** (wire) side, **Bridge**, **IP** and **miscellaneous** statistics. The miscellaneous information covers 'Rate Limit', 'Watch Dog' and 'Roaming' information.

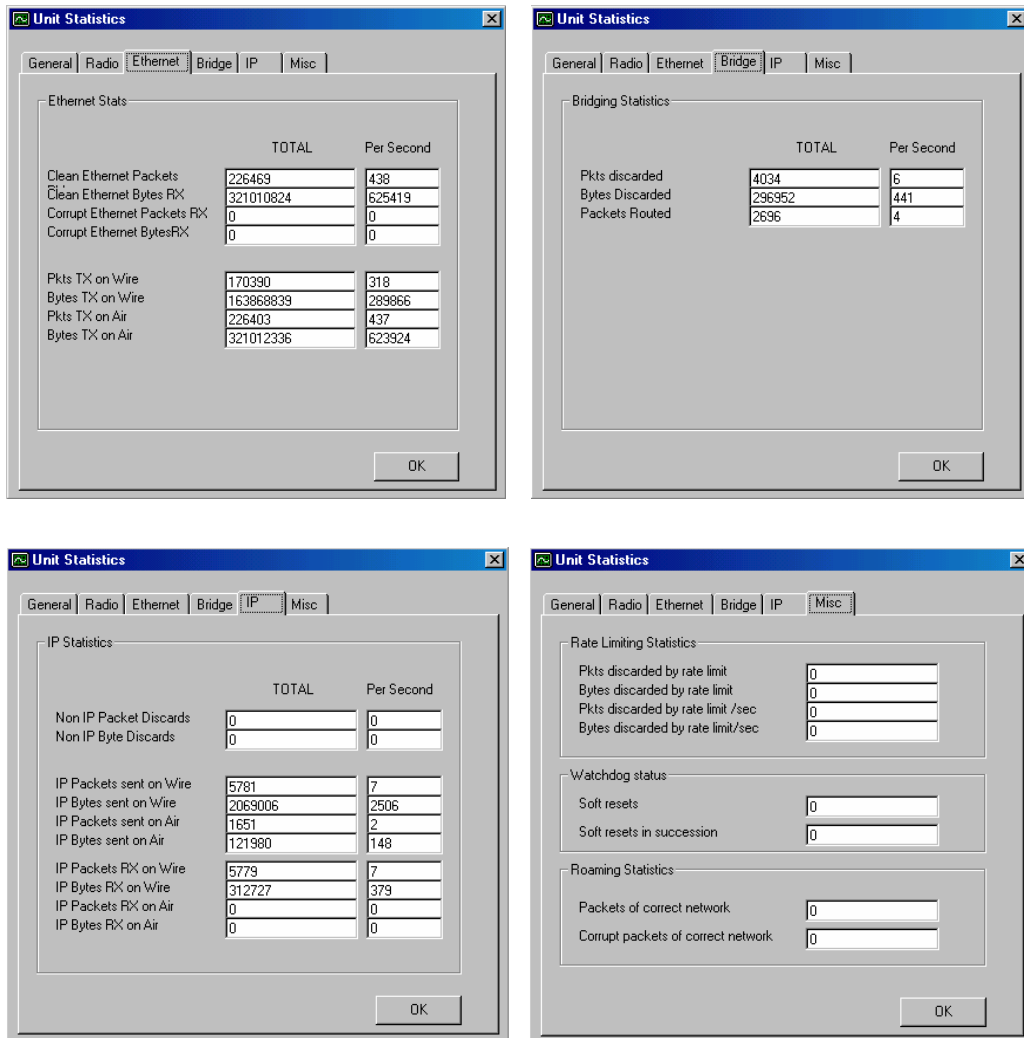

Figure 6.05

Unit Configuration/statistics

Please see the help menu on RF analyser for full graphical explanation of each configuration and Statistic screen.

Firmware Upload

The next option is to upload software to a defined unit, see figure 6.06. Upon selection of the 'Upload' box, the following screen is displayed:

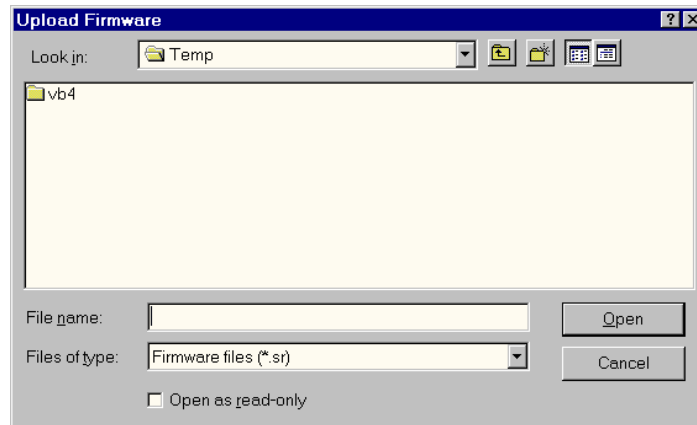

Figure 6.06

This allows the ability to select a new binary file for upload to a particular unit. Once selected, select 'Open' and the file will then be transferred to the currently addressed MODULAR UNIT unit. After a prompt the progress of the upload will be displayed.

Graphs

From the main RF Analyser screen, an option under the statistics tab is to enable graphical output. The following screens show the same data, but with the right hand screen being taken later in time. This screen also shows the re-scaling after the initial 10 minutes, allowing a clearer presentation of the data.

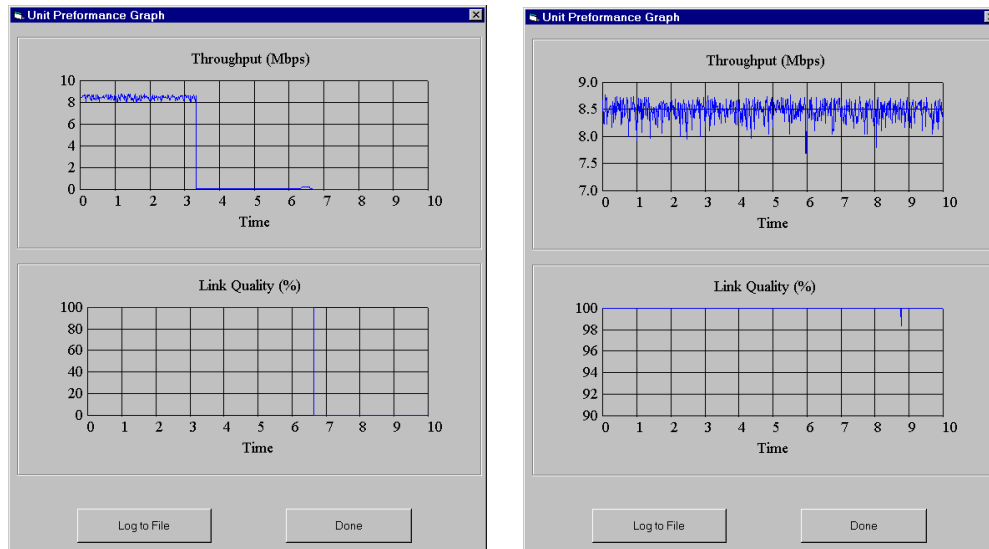

Figure 6.07

If required it is possible to log the data to a file, then select the **'Log to File'** button. See figure 6.08

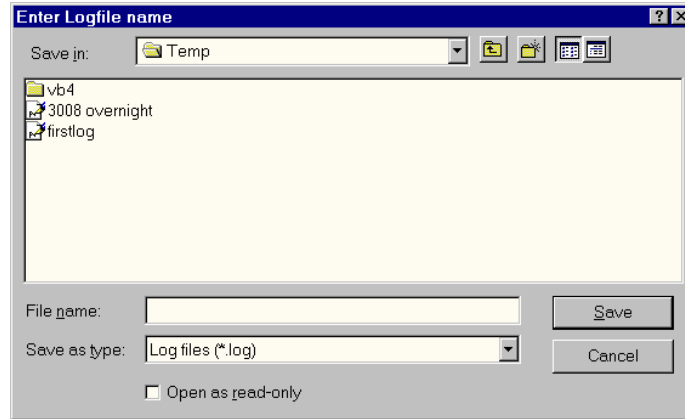

Figure 6.08

Select the file name and then the save button for the monitoring data to be saved to a file.

Highlight Thresholds

It is possible to set Signal quality thresholds to allow for a visual alarm to be displayed against the unit that falls outside these thresholds.

On the top bar, select **'View'** and then **'Set Highlight Thresholds'**. (Yellow exclamation), or Poor threshold, (Red Cross). To activate this facility, click on the yellow exclamation mark.

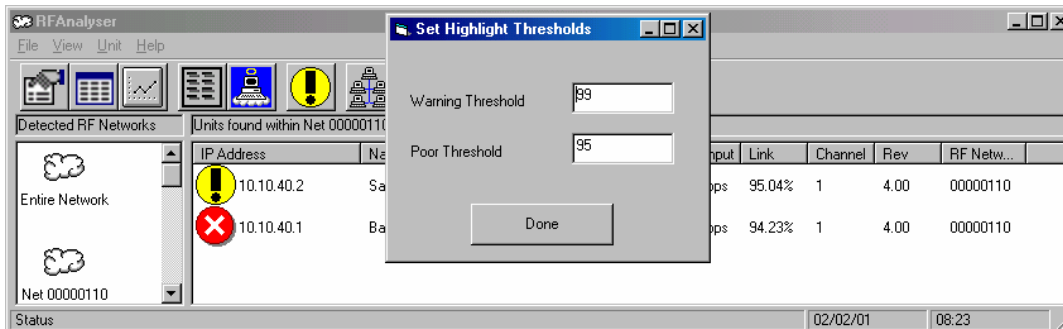

Figure 6.09

Once set, the appropriate symbol will appear to the left of the unit IP address as in figure 6.09.

Set IP Address

It is possible to set an IP address for a radio which is unknown in all respects, by establishing the MODULAR UNIT Wireless Ethernet Bridge **serial number**, (label on back of the radio or within the 'Number' section of the RF Analyser screen), enter the subnet address for the network. Once set, the unit can be configured in all respects required.

Setting the IP address will enable a PC on a similar IP range to access the unit.

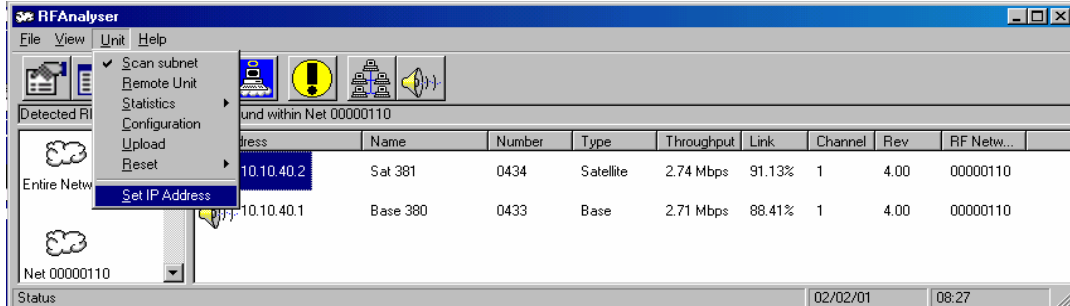

Figure 6.10

Highlight the MODULAR UNIT Wireless Ethernet Bridge to be addressed then select 'Unit' button as in figure 6.10. Enter the serial number into the serial number section then insert your IP address and select "OK" as in figure 6.11.

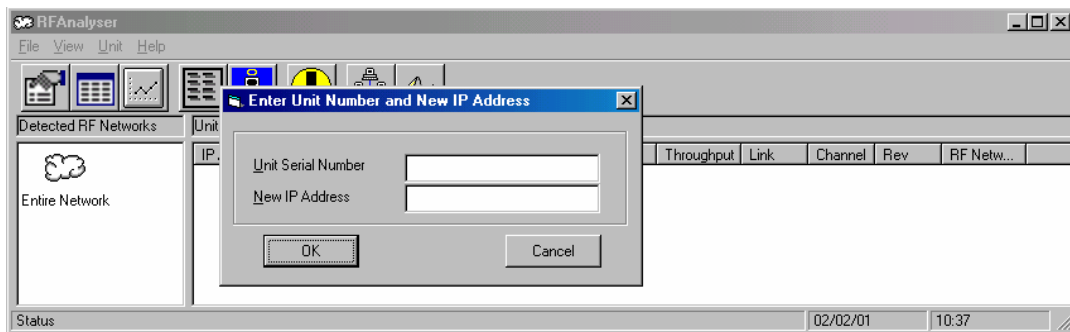

Figure 6.11

Note

Please note that only the last four digits of the serial number are required to change the IP address as is seen in the RF Analyser window.

Unit Configuration/statistics

Please see the help menu on RF analyser for full graphical explanation of each configuration and Statistic screen.

Remote Subnet

It is possible to access an entire subnet that exists beyond any routing device that may exist on a network. By selecting 'Unit' and then selecting 'Scan Subnet', the address will be routed to the required address and the RF analyser will display all and any **Modular Unit** Wireless Ethernet Bridges found within that subnet. Please note that the address required is Type C. i.e. only the first three fields are required. See figure 6.12.

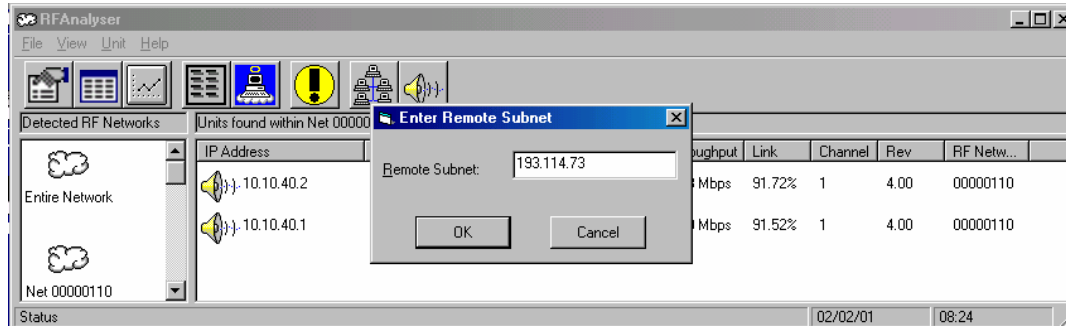

Figure 6.12

Remote Unit

It is also possible to select an individual remote unit once the IP address is known.

See figure 5.13. Select the 'Unit' button, and then select 'Remote Unit'.

Select **TFTP** mode if you are not behind a firewall and therefore be able to see the **Modular Unit** Wireless Ethernet Bridges.

Select **UDP** mode when behind firewalls and monitoring only, I.E. Statistics.

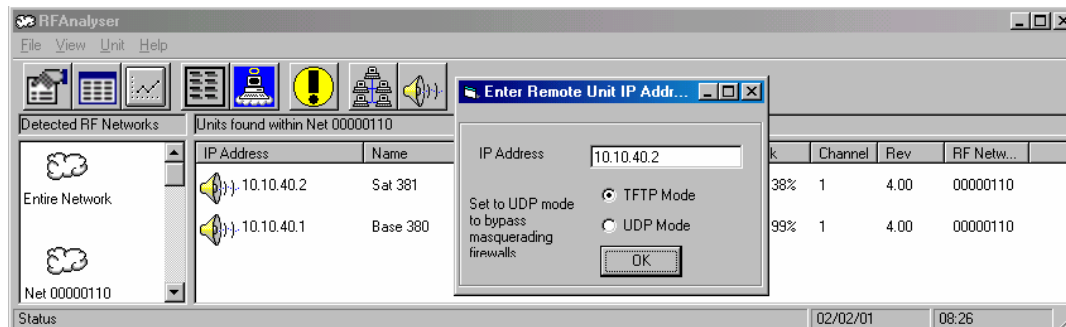

Figure 6.13

Unit Configuration/statistics

Please see the help menu on RF analyser for full graphical explanation of each configuration and Statistic screen.

7 Frequency Channels for 2.4GHz Radios

The frequency channel is selected via the communications set-up menu. Please note that the number is a hexadecimal. Permitted frequencies will vary in different parts of the world. For example, in the 2.4GHz ISM band, channels 0, 14 and 15 are not permitted under either FCC or ETSI standards for licence-free operation.

Channel number	Centre frequency (GHz)
1	2.412
2	2.417
3	2.422
4	2.427
5	2.432
6	2.437
7	2.442
8	2.447
9	2.452
10 (hex: A)	2.457
11 (hex: B)	2.462
12 (hex: C)	2.467
13 (hex: D)	2.472

Figure 7.01: 2.4GHz Band Radio Channels

There are 3 to 4 none overlapping channels depending on placement of the **Modular Unit** Wireless Ethernet Bridges but a total of 13. See Figure 7.02 for further details.

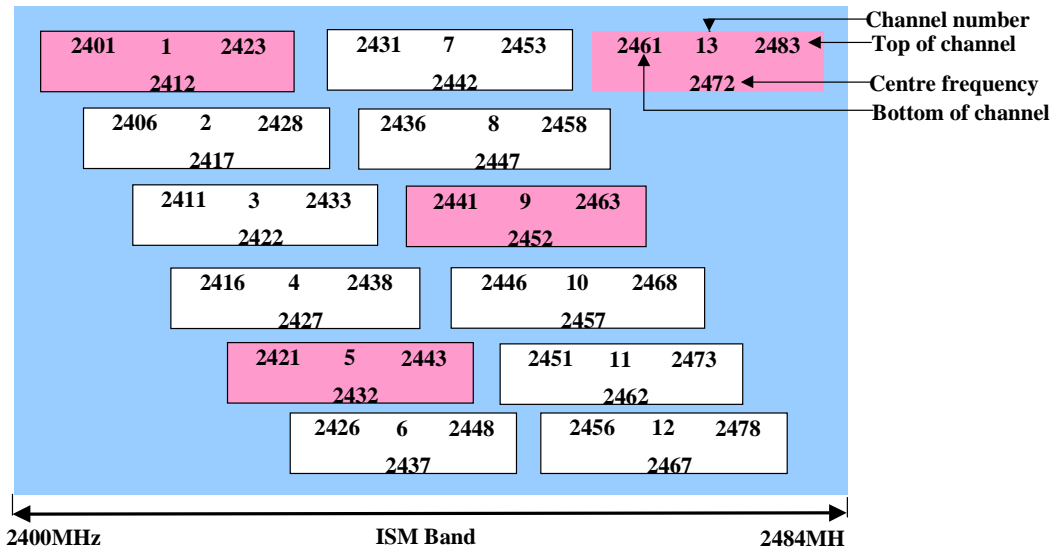

Figure 7.02: 2.4GHz Band Radio Channels

8 Site Survey Requirements

8.1 Overview

Prior to any antenna installation a site survey should have been conducted. The site survey procedure will have determined the correct antenna to be used and the most favourable location for mounting the antenna. This section assumes a site survey has been conducted and details the preparation involved for antenna installation.

Note to End Users:

If a site survey has NOT been conducted and the installer does NOT have previous experience of antenna installations, please consult Authorised Black Box Network Services wireless Ethernet Bridge Value Added Reseller before proceeding with this installation.

8.2 Installation Pre-Requisite Check List

At all times the line of sight² is critical to achieving a good radio signal and the antenna may be positioned on a rooftop, a wall, or any location that achieves the best line of sight. Routing the cable from the antenna to the Network Bridge will also require detailed planning prior to the installation. The following is a check-list of pre-requisites that this use guide assumes have been met and it is strongly recommended that these points be observed as they may affect a successful installation. Please note that not all procedures are applicable due to local country regulations and the nature of the installation.

Site Survey

Detailed results of the conducted radio link test will identify the general location i.e. north/east facing wall or rooftop, that the tests were taken from. This information is critical when deciding on the installation position of the antenna. Just moving the antenna installation site from one side of the building to another could mean loss of line of sight, which may result in an unsuccessful installation! The exact antenna mounting position will also depend on the location of the existing network and the position of the MODULAR UNIT Ethernet Bridge the antenna is being connected to.

Antenna Cable Route

The antenna requires connection to a MODULAR UNIT Wireless Ethernet Bridge radio to complete an installation. Various cables can be used for this purpose. The length of the cable from antenna to bridge is restricted and planning the site of the bridge is critical to the location of the antenna. In addition, drilling through a wall or ceiling will most probably be required to connect the Modular Unit Ethernet Bridge to the internally mounted Ethernet port and power. Planning this route will need consideration of several factors listed as follows:

- Building plan of desired location showing electrical and any other existing cabling routes like telephone or data.
- Fabrication of building materials for drilling purposes.
- Cable route not too tight to prevent damage to the cable.
- Cable route not too short to prevent damage to antenna or Modular Unit Ethernet Bridge.
- Cable route offering best location to antenna.

Please refer to “**Routing the Cable to the LAN**” section for further details of the cable specifications and installation procedure.

² Refer to Line of Sight Requirements on page 25 for further information.

<i>Safety Regulations</i>	All buildings are different and therefore all local site regulations will differ. Always check with the purchaser of the system or owner of the building prior to attending site of any pre-installation safety courses that may be required. Generally antennas are mounted on walls or rooftops and because of this installers must have valid insurance cover prior to any installation process occurring.
<i>Location Access</i>	Being an outdoor antenna installation, access to rooftops and external areas of the building is usually required. This access must be cleared with the appropriate channels prior to the installation.
<i>Power Requirements</i>	Only the MODULAR UNIT Wireless Ethernet Bridge requires power, not the antenna, and will need to be located in the same position as the bridge.
<i>Network Access</i>	To complete Network connectivity between buildings the bridge will require an Ethernet connection to the existing wired Network infrastructure. This will require either an Unshielded Twisted Pair (UTP) RJ45 connection and can be via a hub, switch etc, or direct connection to a patch panel. Fibre can be used with an appropriate transceiver. Cabling will be used to provide connection to the Network and will require a planned cable route from the bridge to the desired network location. Please note that this use guide does not cover this process in any detail and further assistance must be obtained from authorised MODULAR UNIT Wireless Ethernet Bridge Value Added Reseller.
<i>Fabrication of Building</i>	The antenna mounting bracket and MODULAR UNIT Wireless Ethernet Bridge bracket will require fixing to the building or pole. (Black Box Network Services do not supply poles.) Please obtain the correct materials for the installation from a local building supplies outlet for example.
<i>Local Regulations</i>	All wireless LAN equipment distributed throughout Europe must adhere to the European wide European Telecommunications Institute (ETSI) regulation ETS 300.328. Any equipment certified to this standard can operate licence free and all wireless LAN equipment mentioned in this use guide is in accordance with this regulation. Please check for local country adaptations of this standard to ensure accordance with all local regulations.
<i>Other Permissions</i>	Planning permission can also be required according to local town or area regulations for antenna installations. Please check with appropriate channels about any other permission which may be required. For example the UK has a number of heritage listed buildings and therefore will require special permission prior to any installation work. Antennas can be painted with acrylic-based paint for camouflage

8.3 Line of Sight Requirements

“**Line of sight**” means **line of sight**. To achieve the maximum distance and performance of the radio link line of sight is required. When considering the antenna installation location it is critical to always check the line of sight to the other antenna of the point to point or multi-point link. To assist with the determination of line of sight the following are guidelines to follow when installing the antenna:

- Always install as high as possible, but at the very least 3 metres from the ground - this will avoid ground reflections, which can interfere with the radio signal being emitted from the antenna.
- Do not skim over rooftops or other obstacles - this will avoid affecting the radio beam or Fresnel zone.
- Avoid heavy thick trees - this will avoid the radio signal being absorbed by the trunk or leaves.
- Avoid any obstacles - any barrier between the two connecting antennas will create a radio hazard. Either the radio signal will be absorbed completely by the obstacle or only part of it will reach the other antenna therefore resulting in an unreliable connection. Please refer to the following Radio Barriers section for a listing of known radio obstacles.
- Install the antenna at least 3 metres away from any other antenna.
- Directional antennas transmit in one direction - mount on a wall aimed in the required direction to assist line of sight.
- Omni-directional antennas transmit in a 360° azimuth pattern- mount on a rooftop to allow signal to travel 360° from antenna. If mounting on a wall then please be aware of the signal being "lost" by the wall and therefore reducing the overall performance of the antenna. The distance achievable by the antenna is greatly reduced and becomes a directional one due to the absorption of the signal by the wall. Clearance from the wall should be at least 1 metre to avoid any further interference by the antennas reflected signals.
- Avoid mounting the antenna in a hidden position - do not allow any of the antennas to be positioned behind the buildings barriers to avoid loss of signal i.e. the bottom of the antenna slightly hidden by roof edge.
- Mount directional antennas in same polarity - have them both mounted in a horizontal or vertical position. Do not mount one in a horizontal position and the other in a vertical position, as this will reduce the overall radio performance.

8.3.1 Radio Barriers

The following is a listing of identified radio hazards and their level of criticality. When considering the line of sight between two buildings it is useful to know whether radio will pass through these barriers easily. It may be that the radio link will work through the barriers and only a site survey will determine the suitability. Occasionally other buildings can be used to “bounce” signals off to achieve the desired link and again the site survey will have determined this.

Radio Barrier Description	Severity	Examples
Air	Minimal	
Glass	Low	Windows, building facades
Wood	Low	Walls and structures
Plaster	Low	Inner Walls
Asbestos	Low	Building fabrications
Power cables	Low	Cross country Pylons
Leaves	Medium/High	Trees (Water retention)
Water	High	Lakes, Rivers (reflections)
Metal	Very High	Roof barriers, storage containers etc.

8.3.2 Fresnel Zone

When trying to achieve line of sight it is sometimes not possible without obtaining more height. This can be obtained by using longer poles to mount the antennas to. It is important to understand the nature of the radio zone between the two antennas - namely the **Fresnel Zone** - when considering exactly how high the antennas should be mounted.

When a radio beam is travelling from one antenna to another the radio **'beam'** is not narrow along the length of the path like that of a laser but rather 'bulged' in the middle. The 'bulging' in the middle gives the transmission path the features of a 'rugby ball'. The maximum thickness of this 'bulge' occurs at the mid-point between the antennas. This shaped path is called the first Fresnel zone.

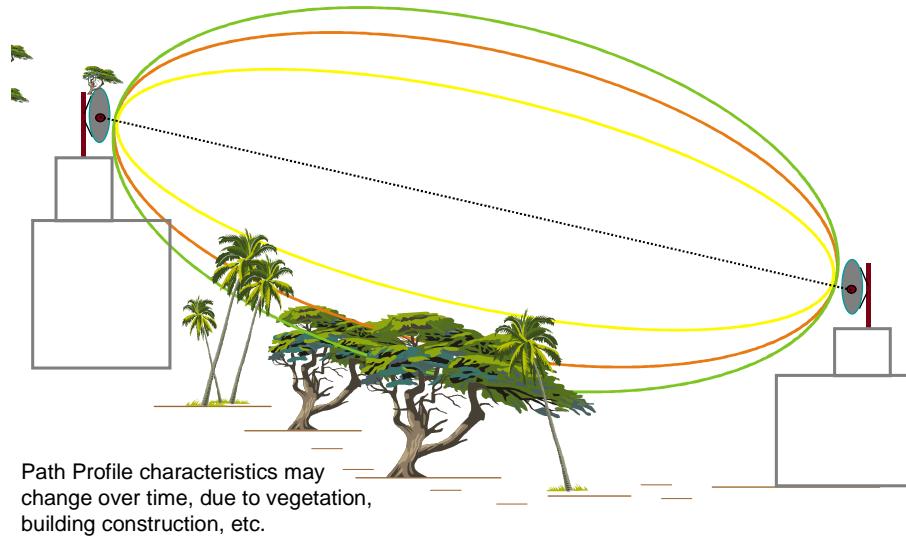

Figure 8.01: Fresnel Zones

The Fresnel zone thickness is a function of path length and frequency.

The radio signal energy is spread out across the breadth of the first Fresnel zone. If any significant part of the zone is blocked a portion of the signal energy will be lost. To avoid this, the antennas must be mounted high enough to allow the first Fresnel zone to clear the obstructions below it (including the earth). In practice if 70% of the first Fresnel zone is clear then it is essentially equivalent to a completely clear path. For longer ranges, the earth curvature will play a role as well. Consequently the sum of Earth curvature and 70% Fresnel criteria is used when working out the needed clearance of the antennas.

The formula for the 70% clearance height is as follows: $H = 0.7 * 5 \sqrt{3 * D / F}$

The formula for the earth curvature is as follows: $H = (6400 - \sqrt{(6400^2 - (D / 2000)^2})) * 1000$

Where H is the height in meters
 D is the overall distance in meters
 F is the frequency in Mega Hertz

For example:

Kilometres	Frequency	Height (Meters)
1	2.450	3.9
5	2.450	9.15
10	2.450	14.2

These figures show that for a 5Km link the antennas should be at least 9.15 metres **above** the highest object between the two antennas. It is worth adding an **extra 1.5 metres** to these heights for local ground conditions. If the ground in between the two antennas is not flat then a local ordinance survey map showing contour lines can help determine the required height for the antennas. Such analysis can be provided by **Black Box Network Services Ltd** as a 'path profiling' service.

NOTE: The antenna location is critical to a successful network connection

8.4 Antenna Mast Mounting and Cable Length Requirements

All antennas are supplied with standard cables consisting of either 0.5m SMA to SMA cable, or 3m and 5m SMA to SMA extensions.

The SMA cables are hand tightened to the antenna at one end and the MODULAR UNIT Wireless Bridge at the other. Do not use any appliances to tighten these connections as this will damage the cable and affect the radio signal.

Connection of the antenna and the MODULAR UNIT Wireless Ethernet Bridge can be either mounted to a wall or other flat surface, or with a pole. The diameter of the pole required will be 1.5" and should be made of sturdy weatherproof material, preferably stainless steel or aluminium (available from most antenna installation suppliers). The height of the pole will be determined by the line of sight requirement of the antenna. This will also change the length of cable to be used between the antenna and the MODULAR UNIT Wireless Ethernet Bridge and must be checked prior to install. Please be aware that in all cases extra cable lengths should only be installed as a last resort.

Typical Maximum distances are calculated from the Link budgets and radio propagation characteristics in free air. The minimum Fresnel zone has to be adhered to.

The MODULAR UNIT Wireless Ethernet Bridge is supplied with a '**Downlink**' cable. This is the connection cable between the Radio and its '**break-out**' box. The maximum length of this cable that can be ordered is 90m, however consideration must be given to other network cables, see Page 6 for further information

No guarantee can be given to any stated distances as the terrain and environment will be different for every installation. As always a RF site survey must be conducted to determine the correct solution.

Routing the Cable to the LAN

This process will occur after the fitting of the antenna and Modular Unit Ethernet Bridge to the pole or other surface but the connectors should not be weatherproofed until final radio tests have been completed.

Drill a cable route to pass the Ethernet cable through to the nearest LAN port located inside the building. The dimensions of the cable will require a **25mm opening**. Connect the bridge and conduct radio signal tests prior to weatherproof sealing of cable route and cable connectors. Do not bend the cable in any abnormal way during the installation process. Do not leave the cable installed in a "tight" position, always allow the cable to bend naturally around corners and do not force the cable through the opening. Bending can damage the cable and the connectors can be damaged when extra force is applied. Secure the cable to the wall and antenna/**Modular Unit** Wireless Ethernet Bridge assembly using cable ties, wall hooks and/or weatherproof tape after completing the installation to ensure the cable is left protected and secure.

NOTE: Please be aware of any local regulations about antenna installation heights.

NOTE: Local made outdoor cable is not an ETSI approved solution so therefore must only be used in extreme cases and advice should be sought from the local Radio Communications authorities.

9 Installing Antennas

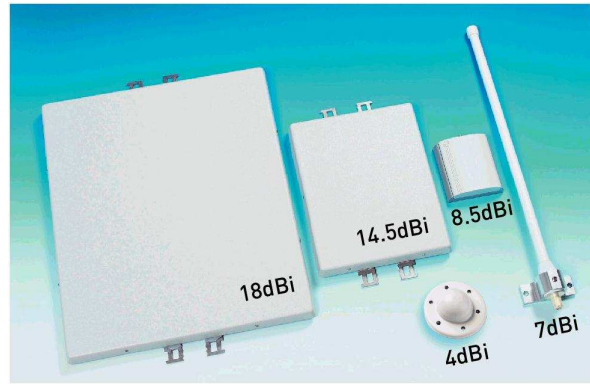

9.1 Overview

The following section refers to the installation process of the antenna. Each section should be referred to and all procedures followed.

- 1) Install bracket and pole for antenna by securing to building fixture.
- 2) Attach antenna to pole using U-bolts and brackets provided.
- 3) Connect base of antenna to grounding device.
- 4) Connect antenna cable and feed back to Modular Unit unit.
- 5) Install Downlink cable and connect to Modular Unit unit.
- 6) Connect opposite end of Downlink cable to 'break-out' box.
- 7) Connect Ethernet and power to 'break-out' box.
- 8) Check for successful communication to other antenna.
- 9) Make necessary adjustments to antenna alignment.
- 10) Weatherproof all exposed cable connections with tape and wax cloth.
- 11) Seal cable route(s) from building.

The 8.5 dBi antenna has two ports at the bottom; only one port is to be used. Each end of the link should be connected to the opposite port for best range. This is due to antenna having two 45° polarised transmission paths at 90° to each other, so if the antennas are connected to the same sides at both ends there is a 3dBi loss, thus resulting in lost range and link stability.

8.5dBi DIRECTIONAL		Part number
	8.5dBi directional Specification: Antenna type: Directional Polarisation: dual 45 degrees L/R Gain: 8.5 dBi RF connector: sma (f) 3dB beamwidth: 75° x 60° (HxV)	10 ANT 3187
	Mounting bracket: Tilt Swivel	15 BKT 3189
	RF antenna cable: 0.5m sma (m) - sma (m)	14 ASY 3182

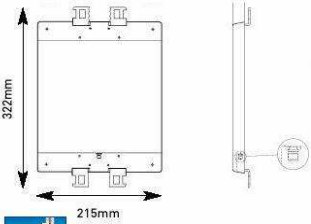

14.5dBi DIRECTIONAL

Part number
10 ANT 3012

14.5dBi directional
Specification:
Antenna type: Directional
Polarisation: Linear, vertical
Gain: 14.5 dBi
RF connector: sma (f)
3dB beamwidth: 35° x 35° (HxV)

Mounting bracket: Tilt Swivel 15 BKT 3188
RF antenna cable: 3m sma (m) - sma (m) 14 ASY 3182/213

Mounting Bracket assembly
for 14.5 and 18dBi directional antennae



18dBi DIRECTIONAL

Part number
10 ANT 3013

18dBi directional
Specification:
Antenna type: Directional
Polarisation: Linear, vertical
Gain: 18.0 dBi
RF connector: sma (f)
3dB beamwidth: 20° x 20° (HxV)

Mounting bracket: Tilt Swivel 15 BKT 3188
RF antenna cable: 5m sma (m) - sma (m) 14 ASY 3182/215

Mounting Bracket assembly
for 14.5 and 18dBi directional antennae



4dBi OMNI-DIRECTIONAL

Part number
10 ANT 3198

4dBi omni-directional
Specification:
Antenna type: Omni-directional dome
Polarisation: Linear, vertical
Gain: 4.0 dBi
RF connector: sma (f)
3dB beamwidth: 360° x 25° (HxV)

RF antenna cable: 0.5m sma (m) - sma (m) 14 ASY 3182



7dBi OMNI-DIRECTIONAL

Part number
10 ANT 3203

7dBi omni-directional
Specification:
Antenna type: Omni-directional
Polarisation: Linear
Gain: 7.0 dBi
RF connector: TNC (f)
3dB beamwidth: 360° x 17.5° (HxV)

Mounting bracket: supplied
RF antenna cable: 0.5m TNC (m) - sma (m) 14 ASY 3265

Always cover all antenna connections with amalgamating tape to stop water seeping into the connector and thus damaging the radio or reducing range.

9.2 Support Structures for the Antenna

Directional Antennas

The bracket and pole provided with the antenna is all that is usually required to connect the antenna to the building. Only when extra height to achieve line of sight is required that a different pole (and sometimes bracket) may be required. When considering the antenna location please be aware of the size of the bracket supplied so as to choose the best positioning of the bracket. The bracket may be installed in a horizontal or vertical position but both antennas must be installed in the same plane (refer to line of sight section for further details).

Omni-directional Antennas

The bracket supplied with Omni-directional antennas will allow connection of the antenna to an existing pole. This pole must be obtained prior to installation and must be made of weatherproof materials and be able to support the weight of the antenna³. The pole should be 1.5" in diameter and cut to the desired length.

Position of the antenna is critical to a successful radio network installation. Check where all satellite buildings are located prior to any Omni-directional antenna installation. The Omni-directional antenna must be mounted on the building to provide 360° coverage to all satellite buildings and this is usually on the highest point of the roof. Take into account all line of sight requirements previously noted in this user guide when installing the antenna.

The brackets supplied with the Omni-directional antennas are different to the directional antennas and they are described below with their installation steps.

Installation of Tilt and Swivel Bracket (8.5dBi)

See mounting instructions supplied with antenna. (8.5dBi antenna only)

Do not tighten fully until the antenna is attached and final radio tests have been conducted.

Installation of Down Tilt Bracket (14.5 & 18dBi)

Antenna brackets that attach to a wall or pole and are secured with either appropriate bolts for wall mounting or special clip for positioning to a pole.

See mounting instructions supplied with antenna. (14.5 and 18dBi antennas only)

Do not tighten fully until the antenna is attached and final radio tests have been completed.

Installation of Omni Directional Bracket

The antenna secures to a wall or other vertical flat surface via an 'L' shaped bracket. This bracket must be secured to the mounting surface with appropriate fixings applicable to the materials used in the mounting surface. The responsibility for selection of such securing bolts lies with the antenna installer.

³ Please refer to specifications of the antennas.

Assembling and Mounting the Antenna

Directional Antennas

All directional antennas have a "front" and "back". The back is a flat steel/aluminium plate and the front will be coloured and made of glass reinforced plastic. Always mount the antenna facing the correct way; plate to the wall, coloured front aiming to the other antenna location. Directional antennas main radio beam will be in one direction and this beamwidth is critical when aligning the antenna. Make sure there are no obstacles near the antenna that will affect this radio path.

The antenna is positioned onto the appropriate bracket according to the previous section. Do not secure antenna until final signal test has confirmed a good radio link. Once confirmed then secure antenna into position.

Omni-directional Antennas

All Omni-directional antennas are cylindrical in design and propagate the radio signal 360°. Make sure there are no obstacles near the antenna that will affect this radio path.

Follow the previous section procedures to attach the antenna to the pole with the brackets provided. Do not secure antenna until final signal test has confirmed a good radio link. Once confirmed secure antenna into position.

9.3 Line of Sight Adjustment

After the antenna is in position and connected to the bridge a radio test should be conducted to ensure a reliable radio link.

Firstly, refer to the RF Analyser software, to set the LED display to either 'Link Quality' or 'Antenna Alignment'.

To assist in the positioning of the antennas, a site survey tool has been produced which will be found on the CD supplied with the MODULAR UNIT Wireless Ethernet Bridge.

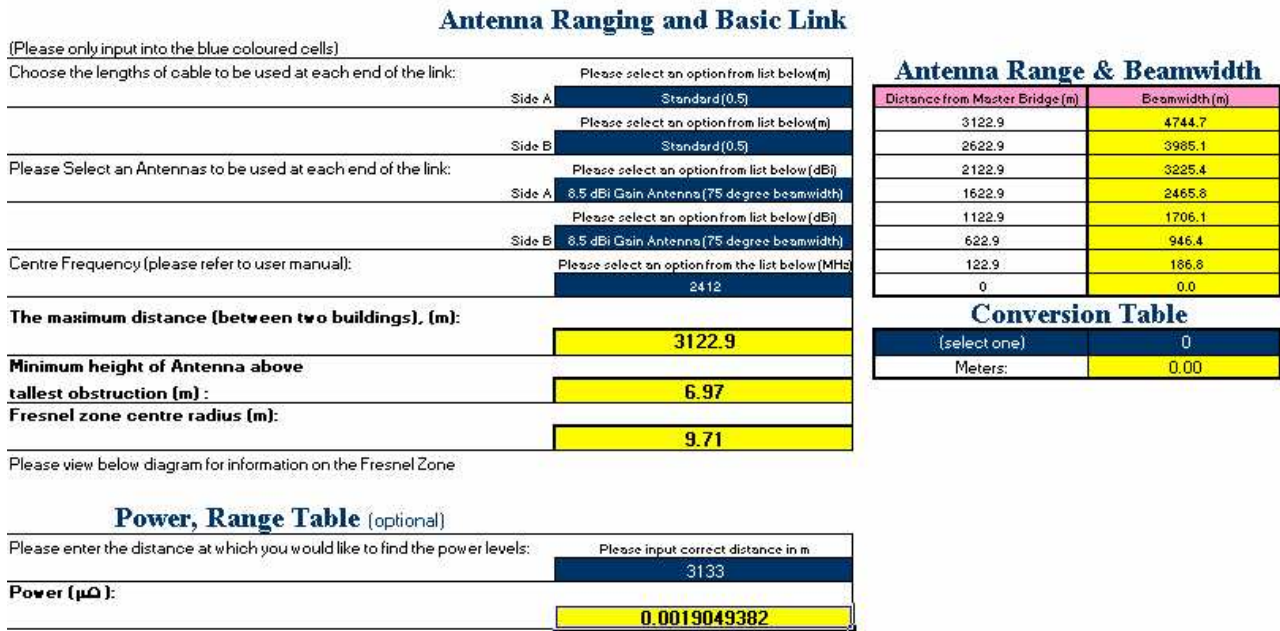

Figure 9.01

Once the radio signal test has been conducted the final securing of all connectors and U-bolts can be secured. Weatherproofing of all outdoor connectors can also be completed.

9.4 Providing a Weatherproof Installation

The **Black Box Network Services Ltds** range of outdoor antennas are fully weatherproof in design. However, the cable connectors and cable route opening will require weatherproof sealing. Make sure that the opening into the building is protected completely with the appropriate sealant, i.e. Silicon Sealant.

The following notes are provided for guidance in ensuring a weather-proof connection is made to antennas located in external environments.

1. Ensure the antenna is correctly aligned and firmly mounted to its fixing assembly and the assembly is firmly mounted to the wall or pole. (NOTE: Anchor bolts will not always be the best type of mounting for the wall mount bracket. The installer should decide at the time which type of bolt would be most suitable for that site.)
2. Ensure the cables are securely fastened to the wall and that the connectors are dirt and moisture free.
3. Attach the cable to the antenna and tighten securely by hand ensuring the cable has an adequate bend radius and is not unduly stretched.
4. Immediately seal the cable/antenna joint using PIB tape (see recommended tape below). Stretch firmly over cable, connectors and antenna input.
5. Immediately apply a generous amount of DENSO water proofing tape, wrapping three or four continuous layers over the previous PIB taped cable and antenna interface. Smooth off the external layer, thus sealing all overlapping layers with excess wax paste.
6. Inspect annually and replace tape if required.

Recommended Insulation Tape

- A) PIB Tape (Polyisobutylene)
This tape is **self amalgamating** black tape which when stretched and wrapped around cables, joints etc., will form an insulated and moisture proof joint between adjacent layers. This tape will not form a seal between tape and metal/plastic surfaces, which require additional use of DENSO tape.
- B) DENSO tape
Wax impregnated cloth tape ideal for all external weather proofing applications.

Recommended Paint (antenna only)

Use of paint will void warranty, i.e. antenna CANNOT be returned to **Black Box Network Services**.

The antennas can be painted to blend in with the building facade. Please note that the antennas will not require paint for a standard installation and should only be when required. Only use Acrylic based paints when covering the antennas and light coatings. If in doubt please check the paint type with the local Authorised **Modular Unit** Wireless Ethernet Bridge Value Added Reseller.

Safety Precautions

Please refer to any documentation provided for the safety regulations of the site prior to the installation. At all times the following should be observed:

- a) Install antenna in safe distance of overhead power lines.
- b) If other telecommunications equipment is operational then may need to be powered down for the installation process i.e. radar or microwave is harmful to human tissue. Please check all previously installed equipment for any possible safety hazard.
- c) Do not install during a thunderstorm.
- d) Do not install during extreme wet or windy conditions.
- e) Take ALL appropriate safety precautions when installing high on buildings or rooftops.

9.5 Earth Grounding of Antenna

It is recommended to earth the antenna assembly to provide a level of protection against lightning or static electrical environments. Earthing cable is not supplied.

Components are available for surge protection. Please consult with **Black Box Network Services** Technical for advice and quotation.

For installations with Directional and Omni-directional antennas using the standard antenna cable assembly and no surge protection, Earthing cable should be installed by connecting the earth cable to the connector of the antenna and joining to the buildings Earthing system. However, as this installation does not have a Lighting Protector device, during a Lighting Strike still some energy may damage the electronics inside the MODULAR UNIT Wireless Ethernet Bridge. Weatherproofing can be applied after the cable assemblies have been installed. Please ensure that the earth strap is following shortest possible route to building ground and not to a Lightning strap.

10. SPECIFICATION

2.4GHz Radio

Parameter	Value
Operating frequency	2.401 to 2.4835 GHz
RF channels	3 to 4 none overlapping depending on siting of Modular Unit Wireless Ethernet Bridges. (13 total)
Standards	ETS300.328 and FCC Part 15 (TBC)
Channel occupancy	22 MHz (approx.)
Transmit power	25 mw (typical)
Modulation	CCK (QMBOK for compatibility with previous generation MODULAR UNIT / FARST WIRELESS ETHERNET BRIDGE Wireless Ethernet Bridges)
Receiver sensitivity	-90, -88, -85, -82 dBm (approx.)
Data rate	1, 2, 5.5, 11 Mbit/s

Physical and Electrical (module)

Parameter	Value
Operating Voltage	+24 to +26 VDC
Current consumption (average)	0.3 A at 15 V (approx.)
Antenna connectors	6 SMA jacks (2 each for port A, B & C)
Data connections	10/100BASET Ethernet
LED's	20 Tri-colour
Configuration connections	Windows 95,98,NT, 2000, XP / RS232
Dimensions	298mm(L) x 305mm(W) x 102mm(D)
Temperature	-40 to +55°C
Humidity	8% to 90%
Ingress Protection	IP65*
EMC	ETS300.826, Part 15 FCC Rules
Weight	0.9Kg

Note that IP65 rating applies if cables supplied by Black Box Network Services are used with the appropriate connector. Black Box Network Services cannot warrant the IP65 rating if alternative cables and connectors are used.

11 Accessories

Antennas

8.5dBi gain – directional	SMA(F)	10 ANT 3007
14.5dBi gain – directional	SMA(F)	10 ANT 3012
18.0dBi gain – directional	SMA(F)	10 ANT 3013
4.0dBi gain – Omni-directional	N(F)	10 ANT 3198
7.0dBi gain – Omni-directional	N(F)	10 ANT 3140

Antenna Cables

RF Cable RG223/U (3m)	SMA(M)/SMA(M)	14 ASY 3182/213
RF Cable RG223/U (5m)	SMA(M)/SMA(M)	14 ASY 3182/215
RF Cable RG223/U (3m)	SMA(M)/N(M)	14 ASY 3182/223
RF Cable RG223/U (5m)	SMA(M)/N(M)	14 ASY 3182/225
RF Cable RG223/U (3m)	SMA(M)/TNC(M)	14 ASY 3182/233
RF Cable RG223/U (5m)	SMA(M)/TNC(M)	14 ASY 3182/235
RF Cable RG223/U (0.5m)	SMA(M)/SMA(M)	14 ASY 3182

Mountings

Pole mount kit (1 set of parts per pole mounted unit)	WL PMT
8.5dBi Antenna Tilt/Swivel Mounting Kit	15 BKT 3189
14.5dBi/18dBi Antenna Tilt/Swivel Mounting Kit	15 BKT 3188

Please note that RG223 antenna cable loss is 0.85 dB per meter and 0.5dB per SMA connector

12 SNMP Implementation

The current implementation of the Black Box Network Services Modular Unit SNMP Agent is one that delivers the most important aspects of the unit's behaviour to keep the management of the unit simple. This involves providing read-only access to the system group of the MIB-II tree, as well as two special MIB entries which are specific to a Black Box Network Services Fast Wireless Ethernet Bridge. The system object identifier for the MODULAR UNIT is 1.3.6.1.4.1.6548.1.2. The following table details the supported nodes:

OID Number	OID Name	OID Type	OID Description
1.3.6.1.2.1.1.1.0	sysDescr	String	Returns "Black Box Network Services Modular Unit " & Firmware Revision & Unit Number
1.3.6.1.2.1.1.2.0	sysObjectID	Object Identifier	Gives the OID of a Black Box Network Services MODULAR UNIT
1.3.6.1.2.1.1.3.0	sysUpTime	TimeTicks	Time since reboot in 100ths of a second. 8,640,000 is one day
1.3.6.1.2.1.1.4.0	sysContact	String	Return string "unknown"
1.3.6.1.2.1.1.5.0	sysName	String	Return 16 char Name set up by Rf Analyser
1.3.6.1.2.1.1.6.0	sysLocation	String	Return string "unknown"
1.3.6.1.2.1.1.7.0	SysServices	Integer	Return the value 2. This indicates that the product operates as a bridge
1.3.6.1.4.1.6548.2.1.1.1.1.0	ariesLinkStatus	Integer	This indicates the status of the radio link. UP = 1 DOWN = 2
1.3.6.1.4.1.6548.2.1.1.1.2.0	ariesLinkQuality	Integer	Returned value is % x 100 in the range 0->10000. 100% is a high quality link.
1.3.6.1.4.1.6548.2.1.1.1.3.0	ariesThroughput	Gauge	The current throughput of the Black Box Network Services Modular Unit in bits/sec.
1.3.6.1.4.1.6548.2.1.1.1.4.0	geminiPortBLinkStatus	Integer	This indicates the status of the radio link UP=1 DOWN=2
1.3.6.1.4.1.6548.2.1.1.1.5.0	geminiPortBLinkQuality	Integer	Returned value is % x 100 in the range 0 ->10000. 100% is a high quality link.
1.3.6.1.4.1.6548.2.1.1.1.6.0	geminiPortBThroughput	Guage	The current throughput of this port in bits/sec
1.3.6.1.4.1.6548.2.1.1.1.7.0	geminiPortCLinkStatus	Integer	This indicates the status of the radio link UP=1 DOWN=2
1.3.6.1.4.1.6548.2.1.1.1.8.0	geminiPortCLinkQuality	Integer	Returned value is % x 100 in the range 0 ->10000. 100% is a high quality link.
1.3.6.1.4.1.6548.2.1.1.1.9.0	geminiPortCThroughput	Guage	The current throughput of this port in bits/sec

In addition to the system entries in the previous table, there are a number of other entries from the MIB-II group. The supported groups are:

Interfaces group – Modular Unit has up to four interfaces, one Ethernet and up to three radio. Information for all are held under this group in MODULAR UNIT. The entries supported within the interface table are shown below.

Please note they are all read only.

OID Number	OID Name	OID Type	OID Description
1.3.6.1.2.1.2.2.1.1	ifIndex	Integer	Unique index for entry
1.3.6.1.2.1.2.2.1.2	ifDescr	String	Interface description
1.3.6.1.2.1.2.2.1.3	ifType	Integer	Type of interface
1.3.6.1.2.1.2.2.1.4	ifMTU	Integer	The size in octets of the largest protocol data unit that can be sent or received on the interface
1.3.6.1.2.1.2.2.1.5	ifSpeed	Gauge	Maximum bandwidth of data stream
1.3.6.1.2.1.2.2.1.6	ifPhysAddress	PhysAddress	MAC Address (where applicable)
1.3.6.1.2.1.2.2.1.7	ifAdminStatus	Integer	Desired interface state: UP(1) DOWN(2)/TESTING(3)
1.3.6.1.2.1.2.2.1.8	ifOperStatus	Integer	The current interface state
1.3.6.1.2.1.2.2.1.9	ifLastChange	TimeTicks	Value is always zero
1.3.6.1.2.1.2.2.1.10	ifInOctets	Counter	Number of received octets on the interface
1.3.6.1.2.1.2.2.1.11	ifInUcastPkts	Counter	Number of unicast packets received by protocols
1.3.6.1.2.1.2.2.1.12	ifInNUcastPkts	Counter	Number of non-unicast packets received by protocols
1.3.6.1.2.1.2.2.1.13	ifInDiscards	Counter	Number of packets discarded without errors
1.3.6.1.2.1.2.2.1.14	ifInErrors	Counter	Number of packets discarded with errors
1.3.6.1.2.1.2.2.1.15	ifInUnknownProtos	Counter	Number of packets discarded for unknown protocols
1.3.6.1.2.1.2.2.1.16	ifOutOctets	Counter	Number of transmitted octets on interface
1.3.6.1.2.1.2.2.1.17	ifOutUcastPkts	Counter	Number of single address packets sent
1.3.6.1.2.1.2.2.1.18	ifOutNUcastPkts	Counter	Number of multicast/ broadcast packets sent
1.3.6.1.2.1.2.2.1.19	ifOutDiscards	Counter	Number of outbound packets discarded without error
1.3.6.1.2.1.2.2.1.20	ifOutErrors	Counter	Number of outbound packets discarded with errors
1.3.6.1.2.1.2.2.1.21	ifOutQLen	Gauge	Number of packets in outbound queue
1.3.6.1.2.1.2.2.1.22	IfSpecific	Object Identifier	OID of MIB for additional definitions for this interface type

ICMP Group – Modular Unit responds to all twenty six entries in this group but the only meaningful statistics are from:

OID Number	OID Name	OID Type	OID Description
1.3.6.1.2.1.5.1	icmpInMsgs	Counter	Number of incoming ICMP messages
1.3.6.1.2.1.5.8	icmpInEchos	Counter	Number of incoming ICMP Echo requests
1.3.6.1.2.1.5.14	icmpOutMsgs	Counter	Number of outgoing ICMP messages
1.3.6.1.2.1.5.1	icmpOutEchoReps	Counter	Number of outgoing ICMP Echo replies

UDP Group – Modular Unit responds to all four main entries in the UDP group (1.3.6.1.2.1.7.1 to 1.3.6.1.2.1.7.4) as well as implementing the listeners table (1.3.6.1.2.1.7.5 and below) to indicate the ports being listened to by Fast Wireless Ethernet Bridge.

SNMP Group – Modular Unit responds to all twenty eight of the entries in the SNMP group (1.3.6.1.2.1.11.1 to 1.3.6.1.2.1.11.30, missing the deprecated entries 1.3.6.1.2.1.11.7 and 1.3.6.1.2.1.11.23) as read only. SNMP Traps cannot be used on Fast Wireless Ethernet Bridge.

In order that this information can be integrated into an existing SNMP Management station, MIB files have been supplied on the application software CD. Both required MIB files, wavreg.mib (containing registration information for the Black Box Network Services extensions to the standard MIB) and wavaries.mib (containing Modular Unit specific information to implement the above) are provided in two versions. These two versions are used to cover the differences in implementation between management systems. Version 2.00 is the preferred (simpler) revision which should be tried first, version 2.01 has extra group and compliance information to satisfy more demanding management systems. Integration of these MIB files into the management station is dependent on which management station is being used. Please consult your user manual for this information.

13 GLOSSARY

BPSK	Binary Phase Shift Keying
CCK	Code Complimentary Keying
dc	direct current
dBi	Gain in decibels relative to an isotropic antenna
dBm	Power in decibels relative to 1 mw
DSSS	Direct Sequence Spread Spectrum
eirp	effective isotropic radiated power
EMC	Electromagnetic Compatibility
ETS	European Telecommunications Standard
ETSI	European Telecommunications Standards Institute
FCC	Federal Communications Commission
FTP	File Transfer Protocol
HDLC	High Level Data Link Control
IF	Intermediate Frequency
IP rating	Ingress Protection
IP	Internet Protocol
ISM	Industrial, Scientific and Medical
LAN	Local Area Network
LED	Light Emitting Diode
MAC	Media Access Controller
Mbit/s	megabits Per Second
MBOK	M-ary Binary Orthogonal Keying
Mcps	MegaChips Per Second
NF	Noise Figure
PA	Power Amplifier
PC	Personal Computer
PCB	Printed Circuit Board
PN	Pseudo-random Noise
QPSK	Quadrature Phase Shift Keying
RF	Radio Frequency
RISC	Reduced Instruction Set Computer
RSSI	Receive Signal Strength Indicator
Rx	Receiver
S/N	Signal-to-Noise Ratio
SNMP	Simple Network Management Protocol
SS	Spread Spectrum
TBA	To Be Announced
TBD	To Be Decided
Tx	Transmitter

14 Module Dimensions and Fixings

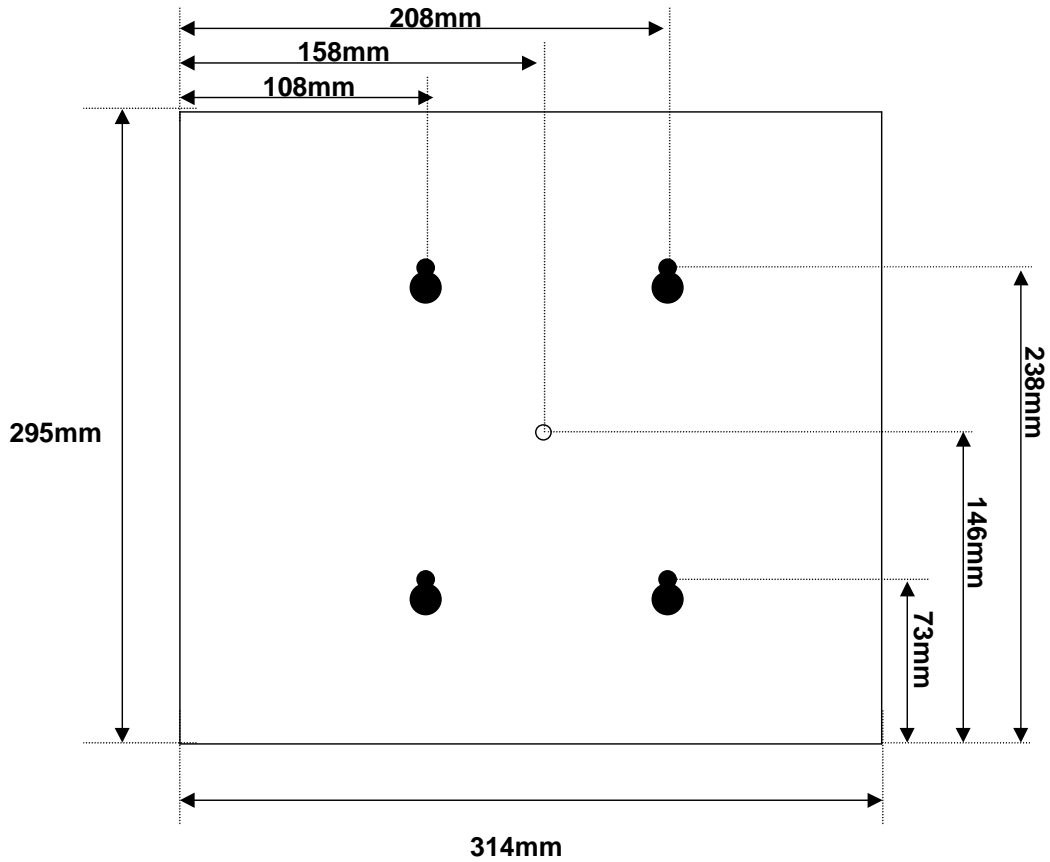

Figure 14.01: Mounting plane dimensions

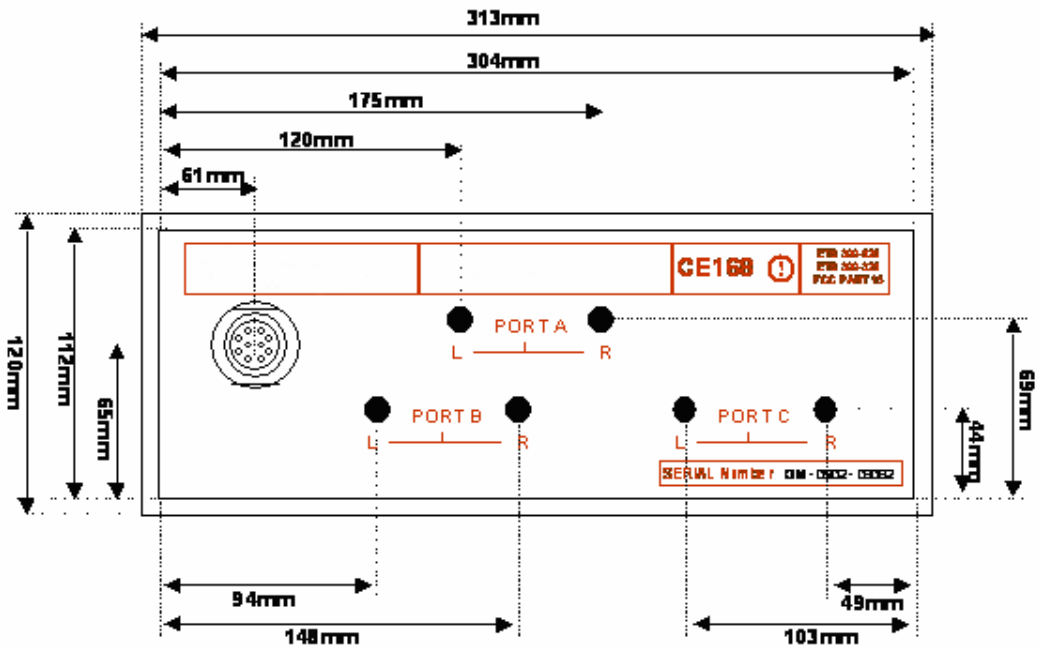

Figure 14.02: Panel dimensions

15 Troubleshooting

This section highlights the troubleshooting routines and possible solutions to any problems that may occur with the installation process of the antenna. At all times please check through this list prior to any further action.

Line of Sight

Check that the radio path is clear of all obstacles. Should any obstacles be in the radio path then conduct a Line of Sight Adjustment test prior to any antenna installation.

Increase Height of Antenna

To obtain the best line of sight extra height may be required. This will require the use of an extended length pole and possibly cable.

Poor Radio Signal Results

When the antennas have been mounted according to the installation procedure and the radio signal test results in a poor radio link there are several checks that can be conducted. Not all of the following suggestions will be used to solve a problem but the following list is intended to provide a comprehensive guideline of any possible causes. It is assumed that all antennas, bridges and cables have been fully tested and proven operational prior to installation.

- 1) Check the cable from antenna to **Modular Unit** Wireless Ethernet Bridge for any abnormal bends.
- 2) Inspect connectors of cable for any noticeable damage.
- 3) Inspect connectors of cable for any water damage.
- 4) Is the antenna mounted and aimed in the correct direction?
- 5) Is the Omni-directional antenna able to propagate the radio signal in a 360° fashion, or are any parts of the antenna hidden?
- 6) Try a different frequency setting on the **Modular Unit** Wireless Ethernet Bridge and monitor results using the radio diagnostics program.
- 7) Is the Network ID (NWID) of the bridges matched? (Please refer to the previous section of this installation use guide for details of how this can be altered)
- 8) Are all cable connections secure?

Should further action be required then please contact local authorised **Modular Unit** Wireless Ethernet Bridge Value Added Reseller.

Building to Building Range Calculations

In all cases the appropriate antenna cable is used .No limitations are set for antenna height. No obstacles on the ground, but included 30% intrusion of Fresnel Zone.

These figures are included for information purposes only.

Antenna	Antenna Height metre	Distance Km Europe	Distance Km North America
Omni 6	4.5	1.3 (radius)	2.8 (radius)
8.5dBi	7.7	3.7	4.1
14.5dBi	11.5	9.1	16.0
18dBi	18.41	16.6	37.0