



MD1970A / MD1970A-DC /MD1970C Modem



**CUSTOMER
SUPPORT
INFORMATION**

Order **toll-free** in the U.S.: Call **877-877-BBOX** (outside U.S. call **724-746-5500**)
FREE technical support 24 hours a day, 7 days a week: Call **724-746-5500** or fax **724-746-0746**
Mailing address: **Black Box Corporation**, 1000 Park Drive, Lawrence, PA 15055-1018
Web site: www.blackbox.com • E-mail: info@blackbox.com

Contents

CHAPTER 1 INTRODUCTION.....	3
SUMMARY OF KEY FEATURES	3
MODELS	3
USING THIS MANUAL	3
CHAPTER 2 INSTALLING THE MODEM	4
SITE PREPARATION.....	4
UNPACKING YOUR HARDWARE.....	4
ADDITIONAL ITEMS YOU NEED	4
HARDWARE OVERVIEW	4
CONFIGURING THE MODEM	6
<i>Jumper S1 – Carrier Detect Control.....</i>	<i>9</i>
<i>Jumper S2 – Transmit Level.....</i>	<i>9</i>
<i>Jumper S3 – 2-wire/4-wire Mode.....</i>	<i>9</i>
<i>Jumper S4 – Call Turnaround Squelch</i>	<i>9</i>
<i>Jumper S5 – Transmit Carrier</i>	<i>10</i>
<i>Jumper S6 – Local Copy</i>	<i>10</i>
<i>Jumper S8 – Signal and Earth Ground</i>	<i>10</i>
<i>Jumper S9 – RTS-CTS Delay</i>	<i>10</i>
<i>Jumper S10 – Carrier Detect Delay.....</i>	<i>11</i>
<i>Jumper S11 – Turnaround Squelch Time.....</i>	<i>11</i>
<i>Jumper S12 – Soft Carrier Turn Off.....</i>	<i>11</i>
<i>Jumper S13 – Anti-Streaming</i>	<i>11</i>
<i>Jumpers S14 and S15 – Self Test or Test Pattern.....</i>	<i>12</i>
CONNECTING A DTE	12
CONNECTING TO A PRIVATE LINE COMMUNICATION CIRCUIT.....	12
Connecting to a DC Power Source (MD1970A-DC).....	12
Connecting to an AC Power Source (MD1970C).....	13
CHAPTER 3 LEDs AND CONTROLS.....	14
FRONT PANEL LEDs	14
FRONT PANEL TEST SWITCH	14
CHAPTER 4 TROUBLESHOOTING	17
LOCAL MODEM TEST	17
LINE AND MODEM TEST	17
CHAPTER 5 SPECIFICATIONS.....	18
GENERAL.....	18
DIMENSIONS AND WEIGHT	18
TEMPERATURE RANGE	18
POWER REQUIREMENTS.....	19
DC POWER REQUIREMENTS (MD1970A-DC).....	19
INTERFACE PIN ASSIGNMENTS	19
APPENDIX A COMPLIANCES	20
FCC REQUIREMENTS FOR TELEPHONE-LINE EQUIPMENT	20
CERTIFICATION NOTICE FOR EQUIPMENT USED IN CANADA.....	20
FEDERAL COMMUNICATIONS COMMISSION AND CANADIAN DEPARTMENT OF COMMUNICATIONS RADIO FREQUENCY INTERFERENCE STATEMENTS	21
NORMAS OFICIALES MEXICANAS (NOM) ELECTRICAL SAFETY STATEMENT	21
INSTRUCCIONES DE SEGURIDAD.....	21

Chapter 1

Introduction

The BLACK BOX® MD1970A standalone modem and MD1970C rack-mount modem are Frequency Shift Keyed (FSK) modems designed for asynchronous half-duplex communication on 2-wire private line circuits or full-duplex communication on 4-wire private-line circuits.

Summary of Key Features

The following list summarizes the modem's key features.

- Bell 202T compatible
- Operates over voice-grade leased lines or private lines
- 0 to 1200 bps operation for unconditioned line.
- 0 to 1800 bps operation for conditioned line (C2).
- Point-to-point or point-to-multipoint polling network
- 4-wire full-duplex or 2-wire half-duplex leased-line configuration.
- Analog Loopback Test, Digital Loopback Test, Self Test, and Test Pattern Transmit.
- LED displays for power, RS-232 control, data status, and test mode.

Models

The BLACK BOX® modems are available in three models:

- ❖ The MD1970A is a desktop modem that comes with an AC power adapter for 115/230 VAC.
- ❖ The MD1970A-DC is a desktop modem that uses DC power.
- ❖ The MD1970C is a rack-mount modem that installs into a standard 19-inch rack.

In this manual, the term “modem” will be used to refer to both models collectively. If information pertains to one model only, that model will be identified by its model number.

Using This Manual

This manual contains all the information you need to install, configure, use, and test your modem.

- ❖ Chapter 1 contains general information on what the modem does, contents of this manual, and contact information for Black Box.
- ❖ Chapter 2 describes how to install and configure the modem.
- ❖ Chapter 3 provides general operating procedures.
- ❖ Chapter 4 provides troubleshooting procedures.
- ❖ Chapter 5 lists the modem's specifications.

Chapter 2

Installing the Modem

This chapter describes how to install the modem.

T Site Preparation

The location where you install your modem should be:

- Within six feet of a 115 or 230 VAC grounded outlet not controlled by a wall switch
- No more than 50 feet from the data terminal equipment
- Away from extremes of temperature, humidity, and appreciable shock.

Note: Be sure that there is a 4-inch minimum space at the back of the modem for signal line and interface cable clearance.

Unpacking Your Hardware

Your package should include at least one MD1970A or MD1970C modem, one RJ-45 jack-to-4 wire leased line cable, and this Installation Guide. If your package contents are damaged or missing, please contact your place of purchase immediately.

Additional Items You Need

To use your modem, you need the following additional items:

- ❖ *All users:* an RS-232 cable to connect a data terminal. The cable must conform to the pin assignments shown on page 19.
- ❖ *Standalone modem users:* a two- or four-wire transmission line or leased line and power supply.
- ❖ *Rack-mount modem users:* a modem rack and an available slot in the rack for installing the modem.

Hardware Overview

Figures 2-1, 2-2, and 2-3 show the front and back modem panels.

Installing the Modem

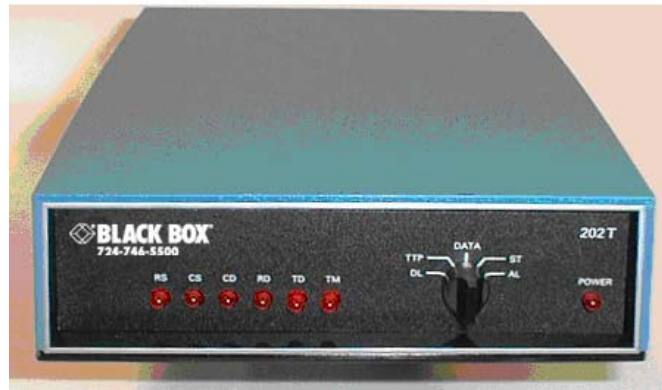

Figure 2-1. Front Panel

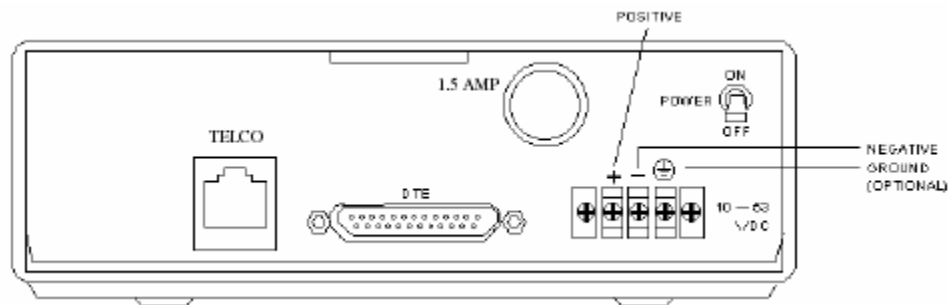

Figure 2-2. Back Panel

On the front panel of the modem, there are:

- ❖ One Power LED and six status LEDs (see page 14)
- ❖ A rotary test switch (see page 14)

On the back panel of the BLACK BOX® MD1970A modem, there are:

- ❖ A power cord or power input connector
- ❖ A power switch for turning the modem on and off
- ❖ A fuse, 3/8 amp, 250 Volt, slow-blow
- ❖ A DB25 female connector for accommodating a DTE device
- ❖ An RJ-45 connector for connecting to a communications line

On the back panel of the MD1970A-DC modem, there are:

- ❖ A power switch for turning the modem on and off
- ❖ A fuse, 1.5 amp
- ❖ A DC power connector
- ❖ A DB25 female connector for accommodating a DTE device
- ❖ An RJ-45 connector for connecting to a communications line

Installing the Modem

Configuring the Modem

The modem obtains some operating characteristics from jumper settings. The default jumper settings are for common 4-wire full-duplex applications. To reconfigure the modem for 2-wire half-duplex and special applications, you must change the default jumper settings.

To change jumper settings, push the two tabs on the back of the modem to open the modem cover and gain access to the jumper settings on the printed circuit board (see Figure 2-4). Then set the jumpers to the desired settings and replace the cover.

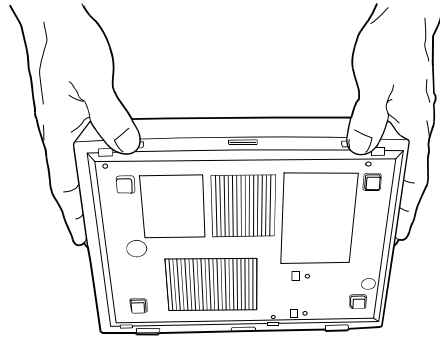

Figure 2-4. Gaining Access to the Modem Jumpers

Figure 2-5 on the next page shows the location of the modem jumpers. Table 2-1 on page 8 summarizes the jumper settings (default settings are **bold**).

Installing the Modem

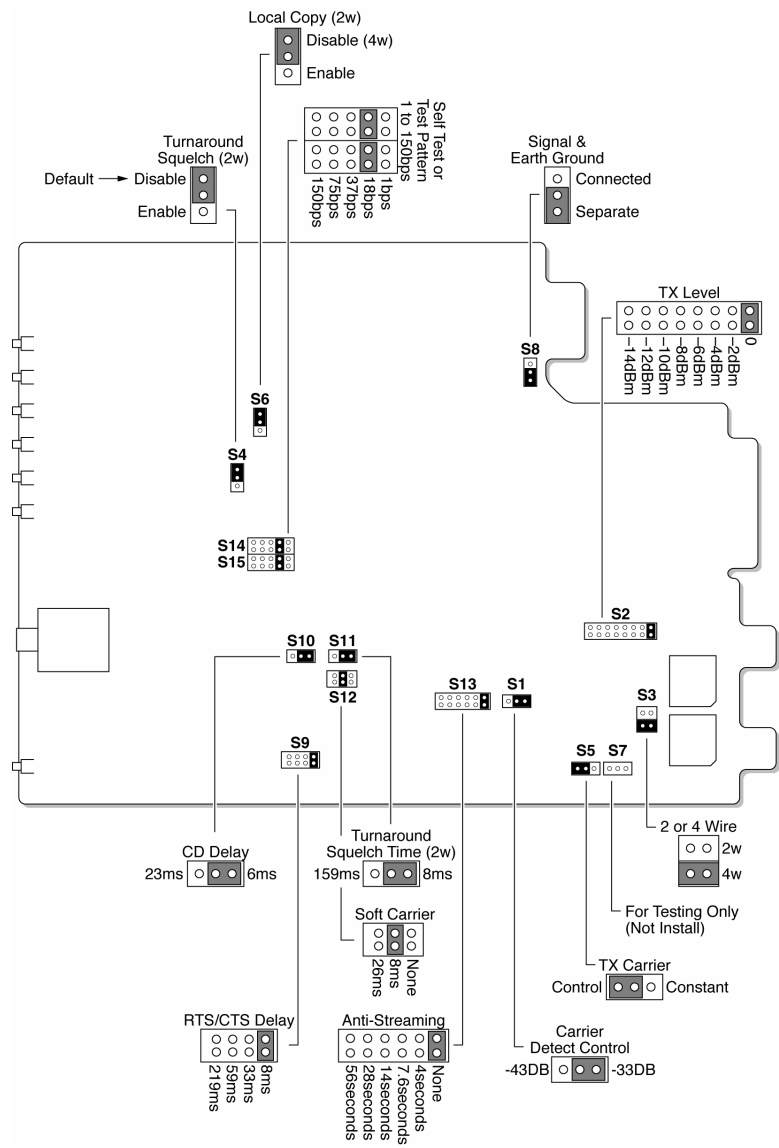

Figure 2-5. Modem Jumper Locations

Installing the Modem

Table 2-1. Jumper Settings

Jumper	Function	Settings	See Page...
S1	Carrier Detect control	-33 dBm -43 dBm	8
S2	Transmit level	0dBm -2 dBm -4 dBm -6 dBm -8 dBm -10 dBm -12 dBm -14 dBm	9
S3	2-wire/4-wire mode	2-wire 4-wire	9
S4	Call turnaround squelch	Enabled Disabled	9
S5	Transmit carrier	Control Constant	10
S6	Local copy	Enabled Disabled	10
S8	Signal and Earth ground	Connected Separate	10
S9	RTS-CTS delay	8 ms 33 ms 59 ms 219 ms	10
S10	Carrier Detect delay	6 ms 23 ms	11
S11	Turnaround squelch time (Enabled by jumper S4)	8 ms 159 ms	11
S12	Soft Carrier turn off	None 8 ms 26 ms	11
S13	Anti-streaming	None 4 seconds 7.6 seconds 14 seconds 28 seconds 56 seconds	11
S14 and S15	Self Test or test pattern (Tx and Rx pattern speed)	1 bps 18 bps 37 bps 75 bps 150 bps	12

Note: The jumper positions in the following sections reflect the position of the jumpers on the modem board when you face the board as indicated in Figure 2-5 on page 7.

Installing the Modem

Jumper S1 – Carrier Detect Control

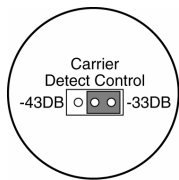

Settings: -33 dBm (*default*)
-43 dBm

Jumper S1 configures the dynamic range of the modem receiver. The selections are either -33 dBm or -43 dBm. If the incoming signal is above -24 dBm, use the default -33 dBm setting. If the modem is operated on the network, use the -43 dBm setting.

Jumper S2 – Transmit Level

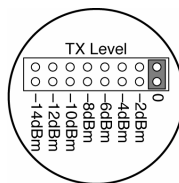

Settings: 0 dBm (*default*)
-2 dBm
-4 dBm
-6 dBm
-8 dBm
-10 dBm
-12 dBm
-14 dBm

Jumper S2 adjusts the modem's transmit level. There are eight transmit level settings you can choose. By default, the modem uses a transmit level of 0 dBm.

Jumper S3 – 2-wire/4-wire Mode

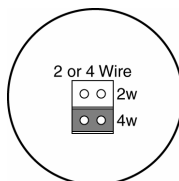

Settings: 2-wire
4-wire (*default*)

Jumper S3 configures the modem for 2-wire or 4-wire operation.

- ❖ When configured for 4-wire full-duplex operation, jumper S5 can be strapped to maintain constant carrier from the master modem to all slave modems at all times after the initial training. This enables the master modem to transmit data to the slave modems, with no RTS-to-CTS delay. This is the preferred operating mode when minimum turnaround is desired.
- ❖ When configured for 2-wire half-duplex operation, the modem encounters an RTS-to-CTS delay when transmitting to slave modems, increasing the turnaround time. Set jumper S5 to controlled carrier for 2-wire half-duplex operation.

Jumper S4 – Call Turnaround Squelch

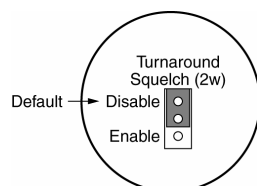

Settings: Enabled
Disabled (*default*)

Jumper S4 configures the modem's Call Turnaround Squelch setting. For 2-wire, half-duplex communications, set this strap to the Enabled position. In this position, the receiver is inhibited for a period of time after the local transmitter is turned OFF. This guards against echoes caused by the transmission just completed. The time is determined by the turnaround squelch time option (jumper S11).

Installing the Modem

For 4-wire, full-duplex communications, keep the jumper set to the default position of Disabled.

Jumper S5 – Transmit Carrier

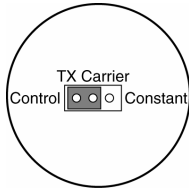

Settings: Control (*default*)
Constant

Jumper S5 places the transmitter under terminal control (default) or turns on the transmitter continuously in a 2-wire half duplex system.

Jumper S6 – Local Copy

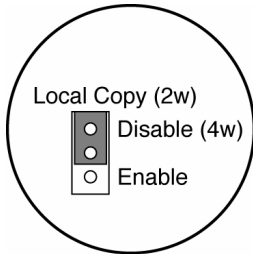

Settings: Enabled
Disabled (*default*)

Jumper S6 must be left in the default position of Disabled when operating on a 4-wire network. It is also normally left in the default Disabled position when operating on a 2-wire network. Strapping this jumper as Disabled inhibits the local receiver from receiving the transmission of the local transmitter.

Jumper S8 – Signal and Earth Ground

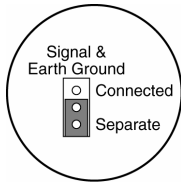

Settings: Connected
Separate (*default*)

Jumper S8 allows Earth GND to be tied to the modem system GND.

Jumper S9 – RTS-CTS Delay

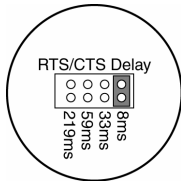

Settings: 8 ms (*default*)
33 ms
59 ms
219 ms

Jumper S9 configures the modem's RTS-CTS delay. Four choices for selecting an RTS-CTS delay are available.

Installing the Modem

Jumper S10 – Carrier Detect Delay

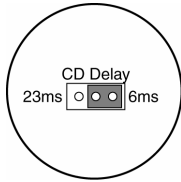

Settings: 6 ms (*default*)
23 ms

Jumper **S10** configures the modem's Carrier Detect turn on Delay timing. The delay chosen must be consistent with the Clear To Send delay selection of the transmitting modem and must be less than the CTS delay. The available delays are 6 ms (default) and 23 ms. The carrier detect drop out is less than 6 ms.

Jumper S11 – Turnaround Squelch Time

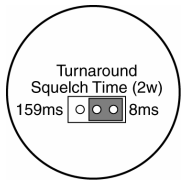

Settings: 8 ms (*default*)
159 ms

Jumper **S11** is used with the call turnaround squelch option (jumper **S4**). The available times are 8 ms (default) and 159 ms.

Jumper S12 – Soft Carrier Turn Off

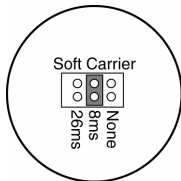

Settings: None
8 ms (*default*)
26 ms

Jumper **S12** configures the modem to either turn off the transmitter immediately upon release of Request To Send, or send a Soft Carrier Turn Off signal of 900 Hz for 8 or 26 ms at the end of each transmission.

Jumper S13 – Anti-Streaming

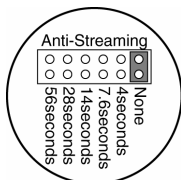

Settings: None (*default*)
4 seconds
7.6 seconds
14 seconds
28 seconds
56 seconds

Jumper **S13** lets you select an anti-streaming time or use no anti-streaming at all. Anti-streaming is typically used in multi-point applications to prevent a malfunctioning slave from occupying the line indefinitely.

When anti-streaming is active, the modem can only transmit data for up to 56 seconds. Thereafter, the modem's transmitter is automatically turned off. The modem then looks for an ON-to-OFF transition of Request To Send (RTS) before proceeding with normal operation.

Installing the Modem

Jumpers S14 and S15 – Self Test or Test Pattern

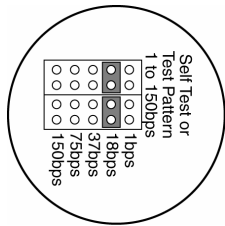

Settings: 1 bps
18 bps (*default*)
37 bps
75 bps
150 bps

Jumpers **S14** and **S15** configures the modem for Self Test or Test Pattern. When the modem is in local Self Test or Test Pattern mode, it generates a dot test pattern. The supported baud rates are 1 bps, 18 bps, 37 bps, 75 bps, or 150 bps.

Connecting a DTE

The modem back panel provides a standard, 25-pin port labeled **DTE**, which connects to an RS-232 device. The connectors for this port conform to the pin assignments shown under “DTE Connector – EIA RS-232-C” on page 19.

The DTE should have a cable no longer than 50 feet, with a Cinch or Cannon plug per DB-19604-432 plus a DB-51225-1 hood or equivalent.

Connecting to a Private Line Communication Circuit

The modem back panel provides an 8-pin RJ-45 connector labeled **TELCO**, which connects to a private line communication circuit. The connectors for this port conform to the pin assignments shown under “Telco Connector” on page 19.

Connecting to a DC Power Source (MD1970A-DC)

The MD1970A-DC back panel accepts a DC voltage source from 10 to 53 VDC and provides 500 Volts isolation. Figure 2-3 on page 5 shows this connector. The MD1970A-DC modem comes with a grounded power cable for attaching the modem to an acceptable DC power source. To attach this cable to the DC power connector on the back panel:

1. Connect the positive wire from the supplied cable to the positive terminal block (labeled +) on the DC power connector. Facing the back of the modem, this is the left terminal block.
2. Connect the negative wire from the supplied cable to the negative terminal block (labeled –) on the DC power connector. Facing the back of the modem, this is the middle terminal block.
3. Connect the ground wire from the supplied cable to the earth ground terminal block (labeled ) on the DC power connector. Facing the back of the modem, this is the right terminal block.

Note: Connecting the ground wire to earth ground is optional for operation. However, it is strongly recommended that you make this connection because doing so provides surge protection for the modem.

Installing the Modem

Connecting to an AC Power Source (MD1970A)

The MD1970A comes with an AC power adapter that connects to a 115/230 VAC power source. On the secondary voltage side, the power adapter connects to the power block on the back of the modem. When making this connection to the modem, align the power adapter with the positive and negative markings on the modem rear panel.

Powering-on the Modem

To supply power to the modem, place the POWER ON switch on the modem back panel to the ON position. The **PWR** LED on the front panel goes ON.

Powering-off the Modem

To turn off power to the modem, place the POWER ON switch on the modem back panel to the OFF position. The **PWR** LED on the front panel goes OFF.

Chapter 3

LEDs and Controls

This chapter describes the LEDs and controls on the modem.

Front Panel LEDs

Table 3-1 describes the LEDs on the modem front panel.

Table 3-1. Front Panel LEDs

LED	Status
PWR	ON = power is being supplied to the modem.
TM	ON = the rotary switch is turned to Analog or Digital Loopback, or the switch is in the Test Pattern transmit mode or Self Test mode and no error is detected.
CD	ON = the modem is detecting a valid carrier.
RD	ON = data is being received or receive data line is in a space condition.
RS	ON = the Request-to-Send line from the DTE is ON.
CS	ON = the Clear-to-Send line from the modem is ON.
TD	ON = data to be transmitted is being furnished to the modem.

Front Panel Test Switch

The modem front panel has a five-position rotary switch that lets you select the modem's operating mode. The five switch positions are:

- ❖ **DATA** — use this position for normal data transmissions.
- ❖ **AL** (Analog Loopback) — this position prepares the modem for testing by the local terminal device. The transmitter output of the modem is disconnected from the output coupling transformer and connected to the modem receiver input. See Figure 3-1.
- ❖ **DL** (Digital Loopback) — this position configures the modem to loop back received data to the transmitter and transmit the data to the remote end. The RS-232-C interface to the terminal is not active during this test. See Figure 3-2.
- ❖ **ST** (Self Test) — this position inhibits the modem from transmitting and receiving data on the COMM LINE. The RS-232-C interface to the terminal is not active during this test. See Figure 3-3.

The test pattern (dot pattern) passes through the transmitter, loops back into the receiver, is demodulated, and is checked for errors. If errors occur, the **TM** LED turns OFF and remains OFF for a period of time that depends on the pattern generator baud rate.

In Analog Loopback and Self Test modes, the received analog data is buffered, amplified by 16 dB (if output level is set to 0 dB), and routed out on the transmit analog pair.

- ❖ **TTP** (Transmit Test Pattern) — this setting forces the transmitter on and transmits data from the test generator to the COMM LINE. The RS-232-C interface lines (RTS, CTS, and Transmit Data) to the transmitter are not

LEDs and Controls

active. See Figure 3-4.

The **TM** LED goes ON when the receive data is good. If there are errors, or if the received data does not compare with the transmitted data, the **TM** LED goes off. The RS-232-C interface lines to the receiver are active during this mode.

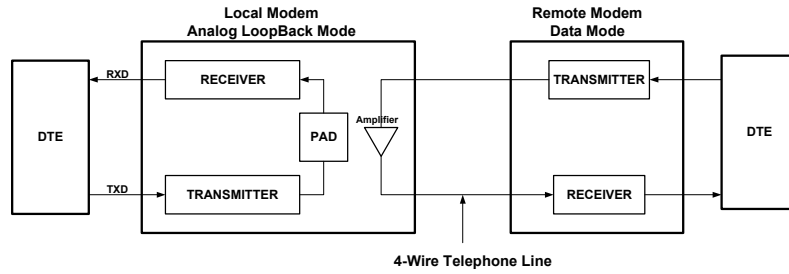

Figure 3-1. Analog Loopback Test

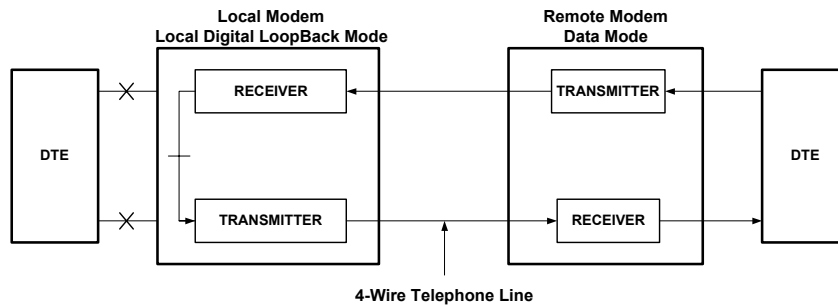

Figure 3-2. Digital Loopback Test

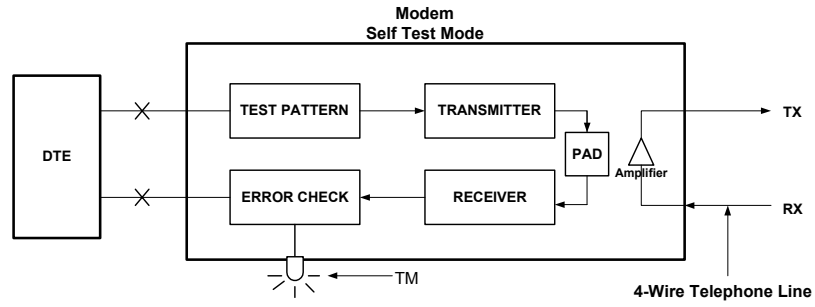

Figure 3-3. Self Test

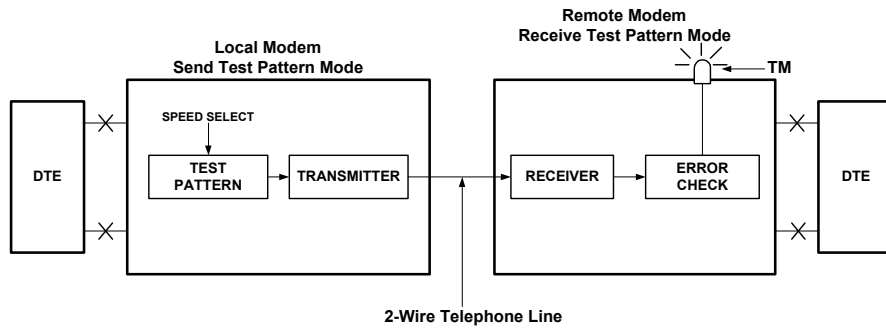

Figure 3-4. Transmit Test Pattern

Chapter 4

Troubleshooting

This chapter describes troubleshooting procedures you can use in the unlikely event you encounter a problem with your modem.

Local Modem Test

The local modem test verifies the local modem's transmitter, receiver, and connection to the locally attached DTE. This test can be run either by generating a data pattern from the locally attached DTE or by having the modem generate a test pattern.

The following procedure describes how to run the local modem test using a locally attached DTE to generate a data pattern.

1. Using the front panel test switch, place the modem in Analog Loopback mode.
2. Turn on the Request To Send line.
3. Use the locally attached DTE to transmit the data pattern and check for data errors on the Receive Data line.

The following procedure describes how to run the local modem test using the modem test pattern instead of a data pattern originated by the local DTE.

1. Using the front panel test switch, place the modem in Self Test mode.
2. The **TM** indicator should turn ON. If the indicator turns OFF or flashes, errors are occurring.

Line and Modem Test

The line and modem test verifies the local modem, the remote modem, and the communications line between them. With this test, the local modem loops back received data to the transmitter and transmits the data to the remote modem. These characters can originate either from a locally attached DTE or by having the modem generate a test pattern.

The following procedure describes how to run the line and modem test using a locally attached DTE to generate a data pattern.

1. Place the remote modem in Digital Loopback mode.
2. Place the local modem in Data mode and transmit a data pattern. Check for data errors on the Receive Data line.

The following procedure describes how to run the line and modem test using the modem test pattern instead of a data pattern originated by the local DTE.

1. Place the remote modem in Remote Test mode.
2. Place the local modem in Remote Self Test mode. The **TM** LED should turn ON and remain ON if the data is error free.

Chapter 5

Specifications

This chapter lists the specifications for the modem.

General

Operation:	2-wire half-duplex or 4-wire full-duplex private line operation.
Data rate:	0-1200 bps asynchronous on worst case line. 0-1800 asynchronous on C2 conditioned line
Modulation:	Phase coherent. Frequency Shift Keyed (FSK)
Carrier frequencies:	Mark 1200 Hz $\pm 1\%$ Space 2200 Hz $\pm 1\%$
Line impedance:	600 ohms $\pm 10\%$ transformer coupled and transient protected.
Transmitter output level:	Selectable from 0 to -14 dBm, in 2 dB steps.
RTS-CTS delay:	8, 33, 59, or 219 ms
Carrier Detect delay:	6 or 23 ms OFF-to-ON, 6 On-to-OFF
Digital interface:	EIA RS-232-C and CCITT V.24.
Package:	Standalone, UL approved.
Turnaround squelch:	8 ms or 159 ms
Anti-streaming:	Option to turn transmitter OFF after selected time, even if RTS is ON
Test features:	Self Test, Analog Loopback, Digital Loopback, and Test Pattern Transmit

Dimensions and Weight

Width:	7.00 inches (17.8 cm)
Length:	9.60 inches (24.4 cm)
Height:	2.25 inches (5.7 cm)

Temperature Range

Operating:	-40 to +85 degrees Celsius (MD1970A and MD1970C) 0° to 50° Celsius (MD1970A-DC)
Storage:	-40 to +85 degrees Celsius
Humidity range:	95% relative, non-condensing

Compliances

Power Requirements

- ❖ 115 VAC + or – 10%: 50/60 Hz
- ❖ 230 VAC + or – 10%: 50/60 Hz
- ❖ 12 to 60 VDC

For applicable models.

DC Power Requirements (MD1970A-DC)

DC Power Supply Voltage:	10 to 53 Volts DC
DC Current Requirements:	500 mA at 12 Volts 200 mA at 24 Volts 100 mA at 48 Volts
Isolation Voltage:	500 Volts DC (between inputs to outputs)
Fuse Rating:	1.5 Amp, Slow Blow

Interface Pin Assignments

DTE Connector - EIA RS-232-C

Pin	RS-232C Circuit	CCITT V.24 Circuit	Function
1	AA	101	Protective Ground
2	BA	103	Transmitter Data
3	BB	104	Receive Data
4	CA	105	Request to Send
5	CB	106	Clear to Send
6	CC	107	Data Set Ready
7	AB	102	Signal Ground
8	CF	109	Data Carrier Detect
9	—	—	+12 Volts Test Only
10	—	—	-12 Volts Test Only
25	—	—	Analog Loopback

Note: All interfaces on the RS-232-C digital connector conform to the requirements of EIA-RS-232-C.

Telco Connector

Pin	Description
4, 5	2-wire mode: transmit/receive pair. 4-wire mode: transmit pair.
3, 6	Receive pair for 4-wire mode.
Polarity of transmit pair or receive pair is not significant. Remaining pins are not used.	

Appendix A

Compliances

FCC REQUIREMENTS FOR TELEPHONE-LINE EQUIPMENT

1. The Federal Communications Commission (FCC) has established rules which permit this device to be directly connected to the telephone network with standardized jacks. This equipment should not be used on party lines or coin lines.
2. If this device is malfunctioning, it may also be causing harm to the telephone network; this device should be disconnected until the source of the problem can be determined and until the repair has been made. If this is not done, the telephone company may temporarily disconnect service.
3. If you have problems with your telephone equipment after installing this device, disconnect this device from the line to see if it is causing the problem. If it is, contact your supplier or an authorized agent.
4. The telephone company may make changes in its technical operations and procedures. If any such changes affect the compatibility or use of this device, the telephone company is required to give adequate notice of the changes.
5. If the telephone company requests information on what equipment is connected to their lines, inform them of:
 - a. The telephone number that this unit is connected to.
 - b. The ringer equivalence number.
 - c. The USOC jack required: RJ-11C.
 - d. The FCC registration number.

Items (b) and (d) can be found on the unit's FCC label. The ringer equivalence number (REN) is used to determine how many devices can be connected to your telephone line. In most areas, the sum of the RENs of all devices on any one line should not exceed five (5.0). If too many devices are attached, they may not ring properly.

6. In the event of an equipment malfunction, all repairs should be performed by your supplier or an authorized agent. It is the responsibility of users requiring service to report the need for service to the supplier or to an authorized agent.

CERTIFICATION NOTICE FOR EQUIPMENT USED IN CANADA

The Canadian Department of Communications label identifies certified equipment. This certification means that the equipment meets certain telecommunications-network protective, operation, and safety requirements. The Department does not guarantee the equipment will operate to the user's satisfaction.

Before installing this equipment, users should ensure that it is permissible to be connected to the facilities of the local telecommunications company. The equipment must also be installed using an acceptable method of connection. In some cases, the company's inside wiring associated with a single-line individual service may be extended by means of a certified connector assembly (extension cord). The customer should be aware that compliance with the above conditions may not prevent degradation of service in some situations.

Compliances

Repairs to certified equipment should be made by an authorized Canadian maintenance facility—in this case, your supplier. Any repairs or alterations made by the user to this equipment, or equipment malfunctions, may give the telecommunications company cause to request the user to disconnect the equipment.

Users should ensure for their own protection that the electrical ground connections of the power utility, telephone lines, and internal metallic water pipe system, if present, are connected together. This precaution may be particularly important in rural areas.

CAUTION:

Users should not attempt to make such connections themselves, but should contact the appropriate electric inspection authority, or electrician, as appropriate.

The LOAD NUMBER (LN) assigned to each terminal device denotes the percentage of the total load to be connected to a telephone loop which is used by the device, to prevent overloading. The termination on a loop may consist of any combination of devices, subject only to the requirement that the total of the load numbers of all the devices does not exceed 100.

FEDERAL COMMUNICATIONS COMMISSION AND CANADIAN DEPARTMENT OF COMMUNICATIONS RADIO FREQUENCY INTERFERENCE STATEMENTS

This equipment generates, uses, and can radiate radio frequency energy and if not installed and used properly, that is, in strict accordance with the manufacturer's instructions, may cause interference to radio communication. It has been tested and found to comply with the limits for a Class A computing device in accordance with the specifications in Subpart B of Part 15 of FCC rules, which are designed to provide reasonable protection against such interference when the equipment is operated in a commercial environment. Operation of this equipment in a residential area is likely to cause interference, in which case the user at his own expense will be required to take whatever measures may be necessary to correct the interference.

Changes or modifications not expressly approved by the party responsible for compliance could void the user's authority to operate the equipment.

This digital apparatus does not exceed the Class A limits for radio noise emission from digital apparatus set out in the Radio Interference Regulation of the Canadian Department of Communications.

Le présent appareil numérique n'émet pas de bruits radioélectriques dépassant les limites applicables aux appareils numériques de la classe A prescrites dans le Règlement sur le brouillage radioélectrique publié par le ministère des Communications du Canada.

NORMAS OFICIALES MEXICANAS (NOM) ELECTRICAL SAFETY STATEMENT

INSTRUCCIONES DE SEGURIDAD

1. Todas las instrucciones de seguridad y operación deberán ser leídas antes de que el aparato eléctrico sea operado.
2. Las instrucciones de seguridad y operación deberán ser guardadas para referencia futura.
3. Todas las advertencias en el aparato eléctrico y en sus instrucciones de operación deben ser respetadas.
4. Todas las instrucciones de operación y uso deben ser seguidas.
5. El aparato eléctrico no deberá ser usado cerca del agua—por ejemplo, cerca de la tina de baño, lavabo, sótano mojado o cerca de una alberca, etc.
6. El aparato eléctrico debe ser usado únicamente con carritos o pedestales que sean recomendados por el fabricante.

7. El aparato eléctrico debe ser montado a la pared o al techo sólo como sea recomendado por el fabricante.
8. Servicio—El usuario no debe intentar dar servicio al equipo eléctrico más allá a lo descrito en las instrucciones de operación. Todo otro servicio deberá ser referido a personal de servicio calificado.
9. El aparato eléctrico debe ser situado de tal manera que su posición no interfiera su uso. La colocación del aparato eléctrico sobre una cama, sofá, alfombra o superficie similar puede bloquea la ventilación, no se debe colocar en libreros o gabinetes que impidan el flujo de aire por los orificios de ventilación.
10. El equipo eléctrico deber ser situado fuera del alcance de fuentes de calor como radiadores, registros de calor, estufas u otros aparatos (incluyendo amplificadores) que producen calor.
11. El aparato eléctrico deberá ser conectado a una fuente de poder solo del tipo descrito en el instructivo de operación, o como se indique en el aparato.
12. Precaución debe ser tomada de tal manera que la tierra física y la polarización del equipo no sea eliminada.
13. Los cables de la fuente de poder deben ser guiados de tal manera que no sean pisados ni pellizcados por objetos colocados sobre o contra ellos, poniendo particular atención a los contactos y receptáculos donde salen del aparato.
14. El equipo eléctrico debe ser limpiado únicamente de acuerdo a las recomendaciones del fabricante.
15. En caso de existir, una antena externa deberá ser localizada lejos de las líneas de energía.
16. El cable de corriente deberá ser desconectado del cuando el equipo no sea usado por un largo periodo de tiempo.
17. Cuidado debe ser tomado de tal manera que objetos líquidos no sean derramados sobre la cubierta u orificios de ventilación.
18. Servicio por personal calificado deberá ser provisto cuando:
 - a. El cable de poder o el contacto ha sido dañado; u
 - b. Objetos han caído o líquido ha sido derramado dentro del aparato; o
 - c. El aparato ha sido expuesto a la lluvia; o
 - d. El aparato parece no operar normalmente o muestra un cambio en su desempeño; o
 - e. El aparato ha sido tirado o su cubierta ha sido dañad



© Copyright 2004. Black Box Corporation. All rights reserved.

1000 Park Drive • Latorence, PA 15055-1018 • 724-746-5500 • Fax 724-746-0746