

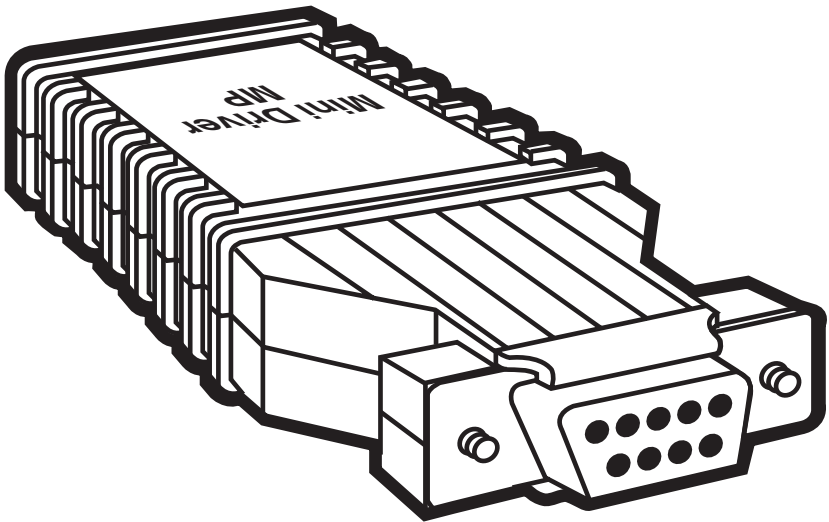

JUNE 1997
ME775A-FSP
ME775A-MSP
ME776A-FSP
ME776A-MSP
ME777A-FSP
ME777A-MSP

Mini Driver MP9



**CUSTOMER
SUPPORT
INFORMATION**

Order toll-free in the U.S. 24 hours, 7 A.M. Monday to midnight Friday: **877-877-BBOX**
FREE technical support, 24 hours a day, 7 days a week: Call **724-746-5500** or fax **724-746-0746**
Mail order: **Black Box Corporation**, 1000 Park Drive, Lawrence, PA 15055-1018
Web site: www.blackbox.com • E-mail: info@blackbox.com

FEDERAL COMMUNICATIONS COMMISSION AND INDUSTRY CANADA RADIO FREQUENCY INTERFERENCE STATEMENTS

This equipment generates, uses, and can radiate radio frequency energy and if not installed and used properly, that is, in strict accordance with the manufacturer's instructions, may cause interference to radio communication. It has been tested and found to comply with the limits for a Class A computing device in accordance with the specifications in Subpart J of Part 15 of FCC rules, which are designed to provide reasonable protection against such interference when the equipment is operated in a commercial environment. Operation of this equipment in a residential area is likely to cause interference, in which case the user at his own expense will be required to take whatever measures may be necessary to correct the interference.

Changes or modifications not expressly approved by the party responsible for compliance could void the user's authority to operate the equipment.

This digital apparatus does not exceed the Class A limits for radio noise emission from digital apparatus set out in the Radio Interference Regulation of Industry Canada.

Le présent appareil numérique n'émet pas de bruits radioélectriques dépassant les limites applicables aux appareils numériques de classe A prescrites dans le Règlement sur le brouillage radioélectrique publié par Industrie Canada.

CE NOTICE

The CE symbol on your Mini Driver MP9 indicates that it is in compliance with the Electromagnetic Compatibility (EMC) directive and the Low Voltage Directive (LVD) of the Union European (EU).

TRADEMARKS USED IN THIS MANUAL

All applied-for and registered trademarks are the property of their respective owners.

NORMAS OFICIALES MEXICANAS (NOM) ELECTRICAL SAFETY STATEMENT

INSTRUCCIONES DE SEGURIDAD

1. Todas las instrucciones de seguridad y operación deberán ser leídas antes de que el aparato eléctrico sea operado.
2. Las instrucciones de seguridad y operación deberán ser guardadas para referencia futura.
3. Todas las advertencias en el aparato eléctrico y en sus instrucciones de operación deben ser respetadas.
4. Todas las instrucciones de operación y uso deben ser seguidas.
5. El aparato eléctrico no deberá ser usado cerca del agua—por ejemplo, cerca de la tina de baño, lavabo, sótano mojado o cerca de una alberca, etc..
6. El aparato eléctrico debe ser usado únicamente con carritos o pedestales que sean recomendados por el fabricante.
7. El aparato eléctrico debe ser montado a la pared o al techo sólo como sea recomendado por el fabricante.
8. Servicio—El usuario no debe intentar dar servicio al equipo eléctrico más allá a lo descrito en las instrucciones de operación. Todo otro servicio deberá ser referido a personal de servicio calificado.
9. El aparato eléctrico debe ser situado de tal manera que su posición no interfiera su uso. La colocación del aparato eléctrico sobre una cama, sofá, alfombra o superficie similar puede bloquea la ventilación, no se debe colocar en libreros o gabinetes que impidan el flujo de aire por los orificios de ventilación.
10. El equipo eléctrico deber ser situado fuera del alcance de fuentes de calor como radiadores, registros de calor, estufas u otros aparatos (incluyendo amplificadores) que producen calor.

11. El aparato eléctrico deberá ser conectado a una fuente de poder sólo del tipo descrito en el instructivo de operación, o como se indique en el aparato.
12. Precaución debe ser tomada de tal manera que la tierra física y la polarización del equipo no sea eliminada.
13. Los cables de la fuente de poder deben ser guiados de tal manera que no sean pisados ni pellizcados por objetos colocados sobre o contra ellos, poniendo particular atención a los contactos y receptáculos donde salen del aparato.
14. El equipo eléctrico debe ser limpiado únicamente de acuerdo a las recomendaciones del fabricante.
15. En caso de existir, una antena externa deberá ser localizada lejos de las líneas de energía.
16. El cable de corriente deberá ser desconectado del cuando el equipo no sea usado por un largo periodo de tiempo.
17. Cuidado debe ser tomado de tal manera que objetos líquidos no sean derramados sobre la cubierta u orificios de ventilación.
18. Servicio por personal calificado deberá ser provisto cuando:
 - A: El cable de poder o el contacto ha sido dañado; u
 - B: Objetos han caído o líquido ha sido derramado dentro del aparato; o
 - C: El aparato ha sido expuesto a la lluvia; o
 - D: El aparato parece no operar normalmente o muestra un cambio en su desempeño; o
 - E: El aparato ha sido tirado o su cubierta ha sido dañada.

Contents

Chapter	Page
1. Specifications.....	6
2. Introduction	8
3. Configuration	9
3.1 Accessing the DIP Switches.....	9
3.1.1 Switch S1 Settings.....	11
3.1.2 Switch S2 Settings.....	12
3.2 Typical Applications.....	13
4. Installation.....	15
4.1 Twisted-Pair Connection.....	15
4.1.1 Twisted-Pair Connection Using Terminal Blocks	15
4.1.2 Twisted-Pair Connection Using RJ-11 or RJ-45.....	19
4.2 Wiring for Multipoint Circuits.....	21
4.2.1 Star Topology	21
4.2.2 Daisychain Topology.....	21
4.3 Connection to the EIA/TIA-574 Interface	22
5. Operation	23

1. Specifications

Protocol —	Asynchronous
Range —	Up to 15 miles
Data Rates —	Up to 115,200 bps
Serial Interface —	DB9, male or female; wired as a DCE according to EIA/TIA-574 standard
Multipoint —	50 drops
Operation —	2- or 4-wire, half- or full-duplex
RTS/CTS Delay —	8 msec or No Delay
Connectors —	All: (1) DB9 male or female; ME775A: (1) 5-screw terminal; ME776A: (1) RJ-11; ME777A: (1) RJ-45
Control Signals —	DSR turns “ON” immediately after the terminal raises DTR; DCD turns “ON” after recognizing the receive signal from the line; CTS turns “ON” after the terminal raises RTS.
Surge Protection —	600W power dissipation at 1 ms
Carrier —	Constantly On or Controlled by RTS
MTBF —	209,384 hours
MTTR —	1 hour
Operating Temperature —	32 to 122°F (0 to 50°C)
Relative Humidity —	5 to 95%, noncondensing
Altitude Tolerance —	Up to 10,000 feet (3048 m)
Compliance —	CE

- Power** — Draws operating power from EIA/TIA-574 data and control signals; no AC power or batteries required. If necessary, 6 to 12 VDC can be applied to pin 9 of the EIA/TIA-574 interface.
- Size** — 2.5"H x 1.2"W x 0.75"D (6.4 x 3 x 1.9 cm)
- Weight** — 0.2 lb. (0.1 kg)

Table 1-1. Distance Table in Miles (Kilometers).

Data Rate (Kbps)	Wire Gauge			
	19	22	24	26
115.2	3.5 (5.6)	2.6 (4.2)	1.4 (2.3)	0.9 (1.4)
38.4	5 (8.1)	2.9 (4.7)	2.2 (3.5)	1.5 (2.4)
9.6	7.1 (11.4)	4.6 (7.4)	3.5 (5.6)	2.8 (4.5)
1.2	9 (14.5)	6.5 (10.5)	5 (8.1)	3.9 (6.3)

2. Introduction

The Mini Driver MP9 is an asynchronous short-range modem that connects to DB9 RS-232 interfaces. The Driver supports EIA/TIA-574 data rates up to 115.2 Kbps over one or two unconditioned twisted pairs. Distances up to 15 miles are attainable at lower data rates (1.2 Kbps, 19 AWG twisted pair). Since the Driver is powered from the interface, it requires no AC power or batteries for operation.

The Mini Driver MP9 can handle up to 50 terminal drops in a multipoint polling environment. For RS-485 and serial-printer applications requiring hardware handshaking, the Mini Driver passes one control signal in each direction. The Mini Driver may be configured for high or low impedance, the carrier may be set to “constantly on” or “controlled by RTS,” and the unit can operate with or without “echo.” RTS/CTS delay may be set for “no delay” or 8 ms.

Options for twisted-pair connection include terminal blocks with strain relief, RJ-11, and RJ-45 connectors. Silicon Avalanche Diodes provide 600 watts per wire of protection against harmful data-line transient surges.

3. Configuration

3.1 Accessing the DIP Switches

The Mini Driver MP9 is configured using two 4-position DIP switches mounted on the printed circuit boards. There are two of these boards: a main PC board and a daughterboard. DIP-switch S1 is located on the underside of the main PC board (see Figure 3-1). DIP-switch S2 is located on the top of the daughterboard (see Figure 3-2).

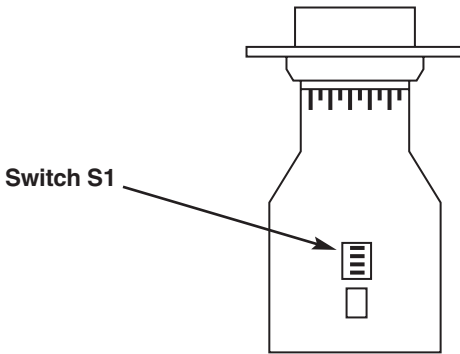

Figure 3-1. Switch S1, located on the underside of the Mini Driver MP9's main PC board.

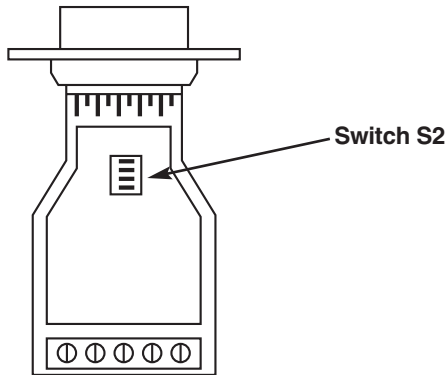

Figure 3-2. Switch S2, located at the top of the Mini Driver MP9's daughterboard.

To access the Mini Driver MP9's main PC board and daughterboard, insert a small flat-blade screwdriver between the connector and the lip of the case (see Figure 3-3) and gently pry open the case.

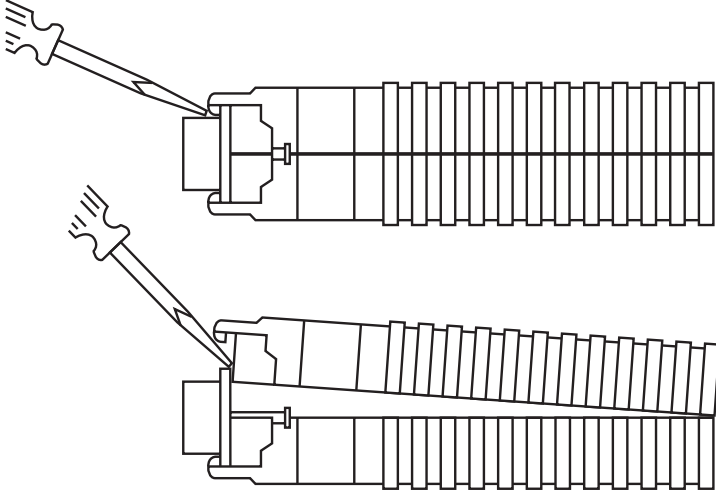

Figure 3-3. Opening the Mini Driver MP9's plastic case with a small screwdriver.

Both DIP-switch S1 and S2 are marked with individual switch numbers 1 through 4. Use these numbers, as well as the "ON" designation to set the switch properly (see Figure 3-4). Use a small screwdriver or similar instrument to set each individual switch.

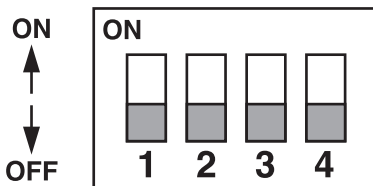

Figure 3-4. Closeup of a DIP switch. All four switches are ON.

3.1.1 SWITCH S1 SETTINGS

DIP-switch S1 is used to configure receive impedance, 2-/4-wire operation and “echo” enable/disable. The table below shows the factory-default settings (printed in bold type) for switch S1. Following the table is a description of each individual switch.

Table 3-1. Switch S1 summary. Factory defaults are shown in bold.

Position	Function	ON Position	OFF Position
S1-1	RCV Impedance	120 ohms	16K ohms typical
S1-2*	2-/4-wire	2-wire	4-wire
S1-3*	2-/4-wire	2-wire	4-wire
S1-4	Echo Mode	Echo ON	Echo OFF

*Note: Switches S1-2 and S1-3 should be switched simultaneously.

S1-1: Receive Impedance

The setting for switch S1-1 selects the impedance of the input receiver. You can select either a “low” impedance of 120 ohms or a “high” impedance of 16K ohms. By selecting the proper impedance for each drop (see Table 3-3), there may be up to 50 receivers in one application.

<u>S1-1</u>	<u>Setting</u>
On	Low (120 ohms)
Off	High (16K ohms typical)

S1-2 and S1-3: 2-/4-Wire Modes

Switches S1-2 and S1-3 are set together to determine whether the Mini Driver MP9 is in 2-wire or 4-wire operating mode. Note: 2-wire mode is half-duplex only.

<u>S1-2</u>	<u>S1-3</u>	<u>Setting</u>
On	On	2-wire mode
Off	Off	4-wire mode

S1-4: Echo Mode

The setting for switch S1-4 determines whether the Mini Driver MP9 echoes data back to the transmitting device (half-duplex mode only).

<u>S1-4</u>	<u>Setting</u>
On	Echo On
Off	Echo Off

3.1.2 SWITCH S2 SETTINGS

DIP-switch S2 is used to configure carrier control, RTS/CTS delay, and communication protocol. The table below shows the factory-default settings (printed in bold type) for switch S2. Following the table is a description of each individual switch.

Table 3-2. Switch S2 summary. Factory defaults are shown in bold.

Position	Function	ON Position	OFF Position
S2-1	Carrier Control	RTS	Constantly ON
S2-2	RTS/CTS Delay	8 ms	No Delay
S2-3*	“XMT Off” Impedance	Intermediate	High
S2-4*	“XMT Off” Impedance	Intermediate	High

*Note: Switches S2-3 and S2-4 should be switched simultaneously.

S2-1: Carrier Control Method

The setting for switch S2-1 determines whether the carrier is “Constantly On” or “Controlled by RTS.” This setting allows for operation in switched-carrier, multipoint, or hardware-handshaking applications.

<u>S2-1</u>	<u>Setting</u>
On	Controlled by RTS
Off	Constantly On

S2-2: RTS/CTS Delay

The switch setting for switch S2-2 determines the amount of delay between the time the Mini Driver MP9 “sees” RTS and when it sends CTS. Note: RTS/CTS Delay setting should be based on transmission timing.

<u>S2-2</u>	<u>Setting</u>
On	8 msec
Off	No delay

S2-3 and S2-4: “Transmit Off” Impedance

Switches S2-3 and S2-4 are set together to determine whether the receiving device “sees” the impedance of the Mini Diver MP9’s transmitter as being “high” or “intermediate” when the transmitter is turned off. The “intermediate” setting is useful in half-duplex environments where the receiving device does not respond well to the “high” setting.

<u>S2-3</u>	<u>S2-4</u>	<u>Setting</u>
On	On	Intermediate Impedance
Off	Off	High Impedance

3.2 Typical Applications

The Mini Driver MP9 is commonly used in five types of applications:

- 4-wire/full duplex/point-to-point
- 4-wire/half duplex/point-to-point
- 2-wire/half duplex/point-to-point
- 4-wire/multipoint
- 2-wire/multipoint

The switch settings *generally* needed to configure the Mini Driver MP9 for these applications are shown in the table on the next page. Note: *Do not change switch settings until you have carefully read Section 3.1.*

Table 3-3. Typical Applications

Switch Settings	Point-to-Point			Multipoint	
	4W	4W HDX	2W	4W	2W
S1-1: Rcv Impedance	ON	ON	ON	Master—ON Slaves—OFF Last Slave—ON	
S1-2: 2-/4-wire	OFF	OFF	ON	OFF	ON
S1-3: 2-/4-wire	OFF	OFF	ON	OFF	ON
S1-4: Echo Mode	OFF	OFF	OFF	OFF	OFF
S2-1: Carrier Control	OFF	ON	ON	Master—OFF Slaves—ON	ON
S2-2: RTS/CTS Delay	ON	ON	ON	OFF	ON
S2-3: "Xmt Off" Impedance	OFF	OFF	OFF	OFF	OFF
S2-4: "Xmt Off" Impedance	OFF	OFF	OFF	OFF	OFF

4. Installation

Once the Mini Driver MP9 is properly configured, it is ready to connect to your system.

4.1 Twisted-Pair Connection

The Mini Driver MP9 supports 2- or 4-wire communication between two or more EIA/TIA-574 devices at data rates up to 115.2 Kbps. There are two essential requirements for installing the Mini Driver MP9.

- 1) These units work in *pairs*. Therefore, you must have one Mini Driver MP9 at each end of a two twisted-pair interface. In multipoint environments, there must be one Mini Driver MP9 at the EIA/TIA-574 host and one at each EIA/TIA-574 terminal.
- 2) To function properly, the Mini Driver MP9 needs two twisted pairs of metallic wire. These pairs must be *unconditioned* dry metallic wire, between 19 and 26 AWG (the higher number gauges may limit distance). Standard dial-up telephone circuits, or leased circuits that run through signal equalization equipment, are *not acceptable*.

For your convenience, the Mini Driver MP9 is available with several different twisted-pair interfaces: RJ-11 jack, RJ-45 jack, and terminal blocks with strain relief.

4.1.1 TWISTED-PAIR CONNECTION USING TERMINAL BLOCKS

If your application requires you to connect one or two pairs of bare wires to the Mini Driver MP9, you will need to open the case to access the terminal blocks. The instructions on the next page will tell you how to connect the bare wires to the terminal blocks and fasten the strain-relief collar in place so the wires won't pull loose.

MINI DRIVER MP9

1. You should already have the case open for the configuration procedure. If not, refer to **Section 3.1**.
2. Strip the outer insulation from the twisted pair(s) about one inch from the end.

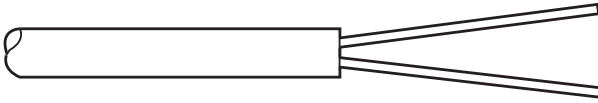

3. Strip the insulation on each of the twisted-pair wires about 0.25".

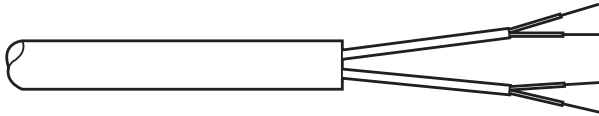

4. In a **two-pair circuit**, connect *one pair* of wires to XMT+ and XMT- (transmit positive and negative) on the terminal block, making careful note of which color is positive and which color is negative.
5. Connect the *other pair* of wires to RCV+ and RCV- (receive positive and negative) on the terminal block, again making careful note of which color is positive and which color is negative.

Ultimately, you will want to construct a two-pair crossover cable that makes a connection with the two Mini Driver MP9s as shown below.

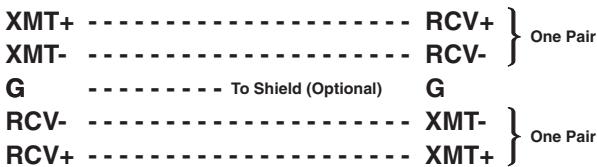

6. In a **single-pair circuit**, use *only the transmit (XMT) pair* as shown below:

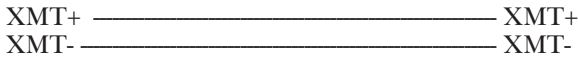

NOTE

If there is a shield around the telephone cable, it may be connected to “G” on the terminal block. To avoid ground loops, we recommend connecting the shield at the computer end only. A ground wire is not necessary for proper operation of the Mini Driver MP9.

7. When you finish connecting the wires to the terminal block, the assembly should look like this:

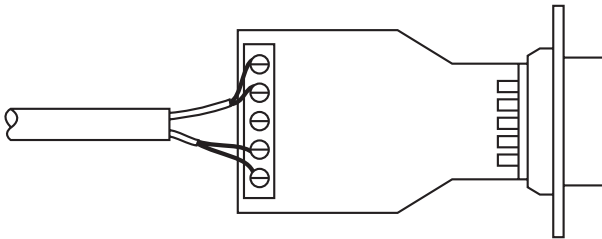

8. Place the two halves of the strain-relief assembly on either side of the telephone wire and press together very lightly. Slide the assembly so that it is about 2 inches from the terminal posts and press together firmly.

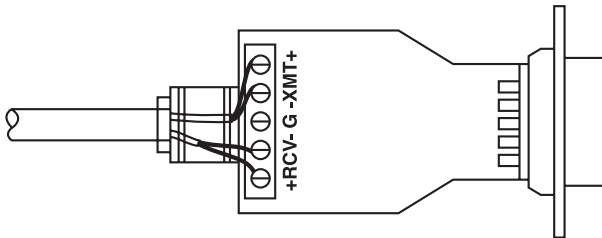

9. Insert the strain-relief assembly with the wire going through it into the slot in the bottom half of the modem case and set it into the recess of the case.

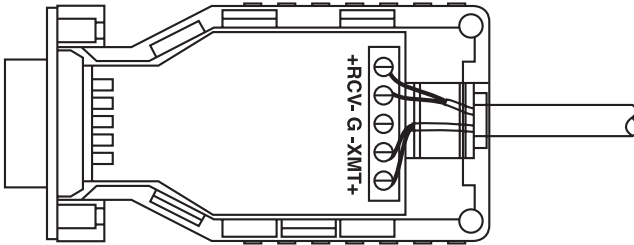

10. Bend the top half of the case as necessary to place it over the strain-relief assembly. *Do not snap the case together yet.*

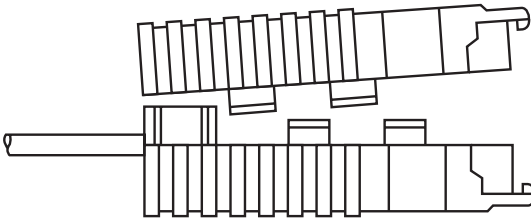

11. Insert one captive screw through a saddle washer, and then insert the captive screw with the washer on it through the hole in the DB9 end of the case. Snap that side of the case closed. Repeat the process for the other side. The cable is installed.

4.1.2 TWISTED-PAIR CONNECTION USING RJ-11 OR RJ-45

The RJ-11 and RJ-45 connectors on the Mini Driver MP9's twisted-pair interface are pre-wired for a standard telco wiring environment. The signal/pin relationships are shown below.

<u>RJ-11</u>	<u>Signal</u>	<u>RJ-45</u>	<u>Signal</u>
1	GND*	1	N/C
2	RCV-	2	GND
3	XMT+	3	RCV-
4	XMT-	4	XMT+
5	RCV+	5	XMT-
6	GND	6	RCV+
		7	GND
		8	N/C

* Connection to ground is optional.

When connecting two Mini Driver MP9s, you must use a crossover cable. The pinouts below show how a crossover cable should be constructed for the following environments: 4-wire RJ-11, 4-wire RJ-45, 2-wire RJ-11, and 2-wire RJ-45.

RJ-11 Cable (4-Wire)

<u>Signal</u>	<u>Pin #</u>	<u>Pin #</u>	<u>Signal</u>
GND*	1	6	GND*
RCV-	2	4	XMT-
XMT+	3	5	RCV+
XMT-	4	2	RCV-
RCV+	5	3	XMT+
GND†	6	1	GND†

* Connection to ground is optional.

RJ-45 Cable (4-Wire)

<u>Signal</u>	<u>Pin #</u>	<u>Pin #</u>	<u>Signal</u>
GND*	2	7	GND*
RCV-	3	5	XMT-
XMT+	4	6	RCV+
XMT-	5	3	RCV-
RCV+	6	4	XMT+
GND†	7	2	GND†

* Connection to ground is optional.

RJ-11 Cable (2-Wire)

<u>Signal</u>	<u>Pin #</u>	<u>Pin #</u>	<u>Signal</u>
XMT+	3	3	XMT+
XMT-	4	4	XMT-

RJ-45 Cable (2-Wire)

<u>Signal</u>	<u>Pin #</u>	<u>Pin #</u>	<u>Signal</u>
XMT+	4	4	XMT+
XMT-	5	5	XMT-

4.2 Wiring for Multipoint Circuits

The Mini Driver MP9 supports multipoint applications using either a star or daisychain topology. Both topologies require special wiring, as well as specific DIP-switch settings for master and slave units.

4.2.1 STAR TOPOLOGY

Using a star topology, you may connect several Mini Driver MP9s together in a master/slave arrangement. Maximum distance between the units will vary based upon the number of drops, data rate, wire gauge, etc. Call Black Box for specific distance estimates.

The figure below shows how to wire the two-pair cables properly for a Mini Driver MP9 star topology. Note that the ground connection is not needed.

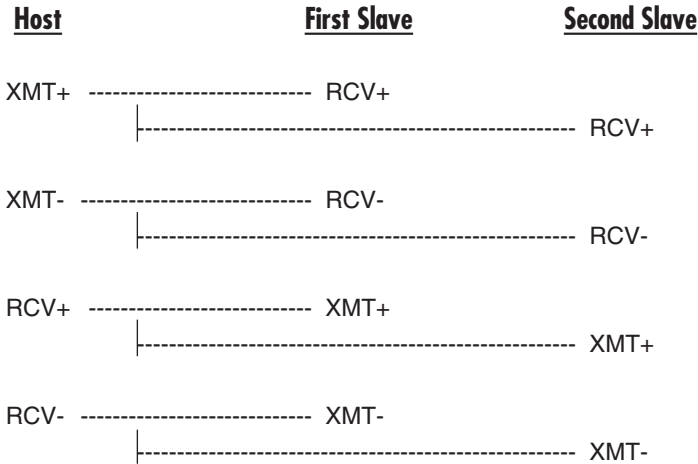

4.2.2 DAISYCHAIN TOPOLOGY

With a daisychain topology, you can connect several Mini Driver MP9s together in a master/slave arrangement. Maximum distance between the units will vary based upon the number of drops, data rate, wire gauge, etc. Call Black Box for specific distance estimates.

The figure on the next page shows how to wire the two-pair cables properly for a Mini Driver MP9 daisychain topology. Note that the ground connection

is not needed.

<u>Host</u>	<u>First Slave</u>	<u>Other Slave(s)</u>
XMT+ -----	RCV+ -----	RCV+
XMT- -----	RCV- -----	RCV-
RCV+ -----	XMT+ -----	XMT+
RCV- -----	XMT- -----	XMT-

4.3 Connection to the EIA/TIA-574 Interface

The Mini Driver MP9 is designed to plug directly into the DB9 serial port of an EIA/TIA-574 DTE device (PC, laptop, host). If you must use a cable to connect the Mini Driver MP9 to the DTE device, make sure that it is a straight-through cable of the shortest possible length—we recommend 6 feet (1.8 m) or less. The DB9 connector on the Mini Driver MP9 is wired according to the EIA/TIA-574 standard, as shown below.

EIA/TIA-574 Standard

<u>DB9</u>	<u>Signal</u>
1.....	CD
2.....	RD
3.....	TD
4.....	DTR
5.....	SG/FG
6.....	DSR
7.....	RTS
8.....	CTS
9.....	(Optional 6- to 12-VDC power)

NOTE

The Mini Driver MP9 is configured as a DCE (Data Communications Equipment), and is therefore designed to connect to a DTE (Data Terminal Equipment). If you need to connect the Mini Driver MP9 to another DCE device, call Black Box for details on constructing the proper crossover cable.

5. Operation

Once the Mini Driver MP9 is properly installed, it should operate transparently—as if it were a standard cable connection. Operating power is derived from the RS-232 data and control signals; there is no “ON/OFF” switch. All data signals from the RS-232 and RS-485 interfaces are passed straight through.