

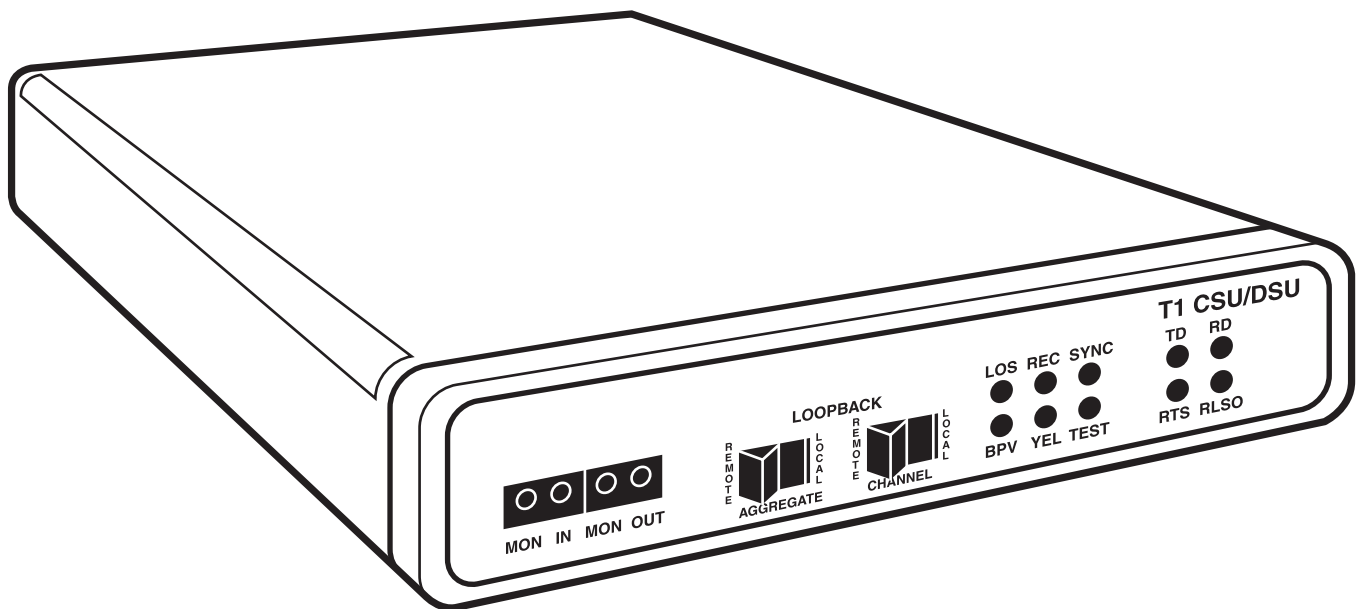

**T1 CSU/DSU (V.35)**  
**T1 CSU/DSU (449)**  
**T1 CSU/DSU (530)**



**CUSTOMER  
SUPPORT  
INFORMATION**

Order toll-free in the U.S.: Call **877-877-BBOX** (outside U.S. call **724-746-5500**)  
FREE technical support 24 hours a day, 7 days a week: Call **724-746-5500** or fax **724-746-0746**  
Mailing address: **Black Box Corporation**, 1000 Park Drive, Lawrence, PA 15055-1018  
Web site: [www.blackbox.com](http://www.blackbox.com) • E-mail: [info@blackbox.com](mailto:info@blackbox.com)

**FEDERAL COMMUNICATIONS COMMISSION  
AND  
INDUSTRY CANADA  
RADIO FREQUENCY INTERFERENCE STATEMENTS**

This equipment generates, uses, and can radiate radio-frequency energy, and if not installed and used properly, that is, in strict accordance with the manufacturer's instructions, may cause interference to radio communication. It has been tested and found to comply with the limits for a Class A computing device in accordance with the specifications in Subpart B of Part 15 of FCC rules, which are designed to provide reasonable protection against such interference when the equipment is operated in a commercial environment. Operation of this equipment in a residential area is likely to cause interference, in which case the user at his own expense will be required to take whatever measures may be necessary to correct the interference.

Changes or modifications not expressly approved by the party responsible for compliance could void the user's authority to operate the equipment.

*This digital apparatus does not exceed the Class A limits for radio noise emission from digital apparatus set out in the Radio Interference Regulation of Industry Canada.*

*Le présent appareil numérique n'émet pas de bruits radioélectriques dépassant les limites applicables aux appareils numériques de la classe A prescrites dans le Règlement sur le brouillage radioélectrique publié par Industrie Canada.*

**INSTRUCCIONES DE SEGURIDAD (Normas Oficiales Mexicanas Electrical Safety Statement)**

1. Todas las instrucciones de seguridad y operación deberán ser leídas antes de que el aparato eléctrico sea operado.
2. Las instrucciones de seguridad y operación deberán ser guardadas para referencia futura.
3. Todas las advertencias en el aparato eléctrico y en sus instrucciones de operación deben ser respetadas.
4. Todas las instrucciones de operación y uso deben ser seguidas.
5. El aparato eléctrico no deberá ser usado cerca del agua—por ejemplo, cerca de la tina de baño, lavabo, sótano mojado o cerca de una alberca, etc..
6. El aparato eléctrico debe ser usado únicamente con carritos o pedestales que sean recomendados por el fabricante.
7. El aparato eléctrico debe ser montado a la pared o al techo sólo como sea recomendado por el fabricante.
8. Servicio—El usuario no debe intentar dar servicio al equipo eléctrico más allá a lo descrito en las instrucciones de operación. Todo otro servicio deberá ser referido a personal de servicio calificado.
9. El aparato eléctrico debe ser situado de tal manera que su posición no interfiera su uso. La colocación del aparato eléctrico sobre una cama, sofá, alfombra o superficie similar puede bloquea la ventilación, no se debe colocar en libreros o gabinetes que impidan el flujo de aire por los orificios de ventilación.
10. El equipo eléctrico deber ser situado fuera del alcance de fuentes de calor como radiadores, registros de calor, estufas u otros aparatos (incluyendo amplificadores) que producen calor.
11. El aparato eléctrico deberá ser conectado a una fuente de poder sólo del tipo descrito en el instructivo de operación, o como se indique en el aparato.
12. Precaución debe ser tomada de tal manera que la tierra física y la polarización del equipo no sea eliminada.
13. Los cables de la fuente de poder deben ser guiados de tal manera que no sean pisados ni pellizcados por objetos colocados sobre o contra ellos, poniendo particular atención a los contactos y receptáculos donde salen del aparato.
14. El equipo eléctrico debe ser limpiado únicamente de acuerdo a las recomendaciones del fabricante.
15. En caso de existir, una antena externa deberá ser localizada lejos de las líneas de energía.
16. El cable de corriente deberá ser desconectado del cuando el equipo no sea usado por un largo periodo de tiempo.
17. Cuidado debe ser tomado de tal manera que objetos líquidos no sean derramados sobre la cubierta u orificios de ventilación.
18. Servicio por personal calificado deberá ser provisto cuando:
  - A: El cable de poder o el contacto ha sido dañado; u
  - B: Objetos han caído o líquido ha sido derramado dentro del aparato; o
  - C: El aparato ha sido expuesto a la lluvia; o
  - D: El aparato parece no operar normalmente o muestra un cambio en su desempeño; o
  - E: El aparato ha sido tirado o su cubierta ha sido dañada.

**TRADEMARKS USED IN THIS MANUAL**

Accunet and AT&T are registered trademarks of AT&T.

UL is a registered trademark of Underwriters Laboratories Incorporated.

*Any other trademarks mentioned in this manual are acknowledged to be the property of the trademark owners.*

**Registration Numbers**

FCC Registration Number (unit) .....GBRUSA-18888-DE-N

UL® listing (power supply) .....UL3458

DS&G Registration Number .....US Safety: E3067

Canadian Use Registration Number .....1596 4190 ACS03-7784

CSA Registration Number (unit) .....CSA LR3067

CSA Registration Number (power supply) .....CSA LR60602

# Contents

Chapter	Page
1. Specifications .....	5
2. Introduction.....	8
2.1 Overview.....	8
2.2 Bantam Jacks .....	8
2.3 Loopback Switches .....	8
2.3.1 Remote CSU/Aggregate Loopback .....	9
2.3.2 Remote Channel Loopback.....	9
2.3.3 Local Channel Loopback Diagnostic .....	9
2.3.4 Local Aggregate Loopback .....	10
2.4 Network LEDs .....	10
2.5 Channel LEDs .....	10
2.6 Rear-Panel Controls and Interface Connectors .....	11
2.7 Channel Interface Connections.....	11
2.7.1 Power Connection .....	12
2.7.2 Network Connection .....	12
3. Installation .....	14
3.1 Introduction.....	14
3.2 Site Preparation .....	14
3.3 Installation Procedure.....	14
3.4 Equipment Cabling .....	14
3.4.1 Network Cabling.....	14
3.4.2 DTE Channel Cabling .....	15
3.4.3 Power Cabling and Initial Power Up.....	15
4. Operation.....	16
4.1 Modify Configuration .....	16
4.2 Configuration Tables.....	22
Appendix: FCC Documentation Requirements .....	25

# 1. Specifications

## Configuration

- DIP-switch selectable, readily accessible from the rear panel

## Aggregate

- Recommended Cable Requirement: STP
- Line Rate: 1.544 Mbps  $\pm$ 50 bps
- Line Format: AMI or B8ZS
- Framing Format: D4 or ESF(Fe)
- Pulse Characteristics: AT&T® 62411 compliance
- Output Amplitude: 2.4 to 3.3 V peak to base
- Receiver Sensitivity: 0 to -26 dB
- Line Build-Out (CSU): 0 dB, -7.5 dB, -15 dB
- Line Distance (DSX-1 Mode): 0 to 655 feet (0 to 200 m)
- Line Distance (CSU Mode): 0 to 6000 feet (0 to 1828.8 m) with 24 AWG
- Interface: RJ-45
- Density Monitoring: 1 of 16, 1 of 48, 1 of 64, or none

## Internal CSU

- Meets FCC Part 68 requirements
- Meets AT&T Pub 62411
- Local and Remote Loopback Diagnostics
- Type 1 Keep-Alive Signal

## Clocking Modes

- Internally provided
- External from network (loop)
- External from channel

## DTE Channels

**MT100A-35-R2:** CCITT V.35 interface; 34-pin M block (female) connector

**MT100A-449-R2:** EIA RS-449 interface; DB37(female) connector

**MT100A-530-R2:** EIA RS-530 interface; DB25 (female) connector

- Density: Alternate DS0 (Fractional T1), Bit 7 stuffing, or None
- Selectable DTE Channel Rates N x 56 kbps (56, 112, 168, 224, 336, 448, 672, or 1344)
- Selectable DTE Channel Rates N x 64 kbps (64, 128, 192, 256, 384, 512, 768, or 1536)

## Compatibility

- AT&T Pub 62411
- AT&T Pub 54019A
- Carrier T1 Service Offerings
- Carrier Fractional T1 Service Offerings

## Approvals

- FCC Parts 15 and 68
- UL
- CSA

## Diagnostics

- Local Aggregate Loopback
- Remote CSU Loopback
- Local and Remote Channel Loopbacks
- Tx/Rx Monitor Jacks and Network In and Network Out Jacks
- Test LED lit when active

**Front-Panel Network Indicators**

- Loss Of Signal (LOS)
- Bipolar Violations (BPV)
- Synchronization
- Red Alarm
- Yellow Alarm
- Test

**Front-Panel DTE Channel Indicators**

- Transmit Data (TD)
- Receive Data (RD)
- Request To Send (RTS)
- Receive Line Signal Detect (RLSD)

**Mean Time Between Failure (Estimated)**

40,000 hours

**Environmental**

- Temperature: 32 to 122°F (0 to 50°C)
- Storage Temperature: -4 to +176°F (-20 to +80°C)
- Relative Humidity: Up to 95% noncondensing
- Maximum Altitude: 15,000 ft. (4572 m)

**Standalone Unit**

- Size: 1.5"H x 7.25"W x 10.5"D (3.8 x 18.4 x 26.7 cm)
- Weight: 2 lb. (0.9 kg)
- Power: External wallmount power supply



## 2. Introduction

### 2.1 Overview

The T1 CSU/DSU is a high-speed T1 format processor with one of three interfaces for the DTE channel: CCITT V.35, RS-449, or RS-530. It is capable of processing data at speeds from 56 kbps to 1.536 Mbps, depending upon the format and density requirements of the application. It provides all the framing and density requirements for data transmission across predefined network facilities, such as Accunet®.

The T1 CSU/DSU, because of its unique design, is able to accept timing information from any clock. Timing information may be derived from the receive data, an external DTE, or from the internal crystal oscillator. The T1 CSU/DSU has a series of selectable diagnostics that allow you to quickly and accurately troubleshoot the T1 CSU/DSU and the associated network.

The T1 CSU/DSU has a built-in CSU which complies with AT&T Publication 62411. This allows you to attach the T1 CSU/DSU directly to the T1 circuit. This CSU can be enabled or disabled with a simple switch setting so that the unit can act as a DSU or as a DSU/CSU. It can also be used as a high-speed line driver to extend high-speed data circuits up to 6000 feet (1828.8 m) over shielded twisted-pair (STP) cable.

The T1 CSU/DSU contains all the controls and indicators necessary to configure, monitor, diagnose, and operate the system. The front panel contains four bantam jack receptacles for network data monitoring and test signal injection, loopback selection switches for aggregate and channel loopbacks, and a series of LEDs that reflect the status of both the network and the DTE channel.

### 2.2 Bantam Jacks

The bantam jacks, located on the T1 CSU/DSU's front panel, provide easy access to both monitor the T1 service without interrupting the transmission of information or to inject a test signal to exercise the T1 circuit.

To monitor the T1 service, connect a test set to the T1 CSU/DSU via the Transmit Monitor (NET TX MON) bantam jack and the Receive Monitor (NET RX MON) bantam jack. This allows the user to monitor the T1 service without interrupting the information flow.

To inject and receive a test signal across the T1 transmission facility, connect the test set into the IN (NET TX IN) and OUT (NET RX OUT) bantam jacks. Then, place the T1 CSU/DSU in Remote Channel Loopback. In this configuration, the operator can inject a known signal and receive it back via the network for testing purposes. This is an interruptive test. Data integrity can not be guaranteed during this test.

### 2.3 Loopback Switches

There are two loopback switches on the T1 CSU/DSU's front panel. Both switches allow the user to test individual sections of the data transmission path. This ability to test these individual paths allows you to isolate, diagnose, and then perform corrective action to resolve data transmission problems in the network.

**2.3.1 REMOTE CSU/AGGREGATE LOOPBACK**

The Remote CSU/Aggregate Loopback (see Figure 2-1) test lets you verify the logic from the local interface through the remote aggregate and back to the local channel interface. To select this test, position the Aggregate Loopback switch in the Remote position. When complete, return this switch to the center position.

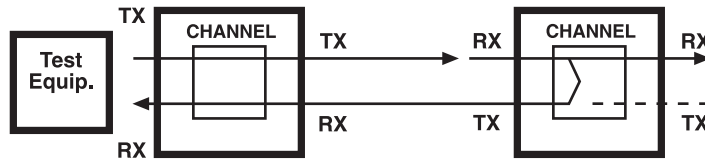

Figure 2-1. Remote CSU/Aggregate Loopback.

**2.3.2 REMOTE CHANNEL LOOPBACK**

To verify the remote unit's channel logic from the local unit (Figure 2-2), select the remote position of the Aggregate Loopback switch. When complete, reposition this switch to the center position.

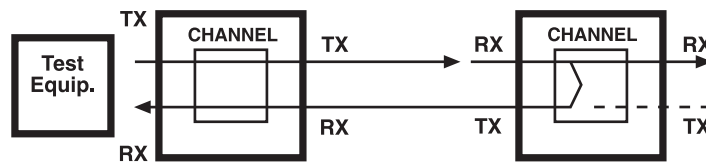

Figure 2-2. Remote Channel Loopback.

**2.3.3 LOCAL CHANNEL LOOPBACK DIAGNOSTIC**

Local Channel Loopback Diagnostic (Figure 2-3) enables you to verify the channel interface. To run this test, position the Channel Loopback Switch in the Local position. When complete, reposition the switch to the center position.

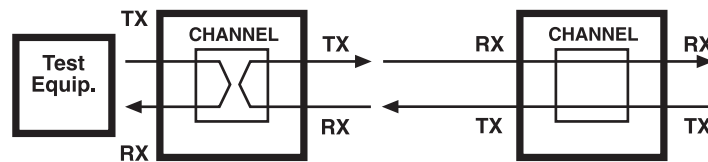

Figure 2-3. Local Channel Loopback.

## 2.3.4 LOCAL AGGREGATE LOOPBACK

The Local Aggregate Loopback diagnostic (Figure 2-4) lets you verify the T1 CSU/DSU logic from the channel interface, through the aggregate, and return to the channel interface. To select this test, position the Aggregate Loopback switch in the Local position. When complete, reposition the switch to the center position.

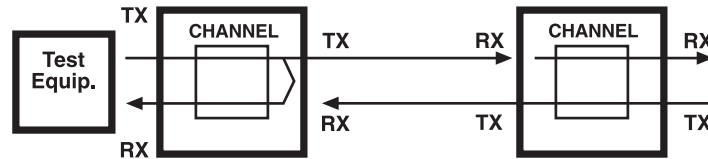

Figure 2-4. Local Aggregate Loopback.

## 2.4 Network LEDs

Six LEDs indicate network function of the unit: Loss Of Signal (LOS), Bipolar Violations (BPV), Red and Yellow alarms, Sync, and Test.

**LOS LED** — when lit, indicates the lack of sufficient signal pulses (marks) at the network receiver. The LED lights when more than 175 consecutive zeros are received and is extinguished when the next mark is detected.

**Bipolar Violations LED** — when lit, indicates that a pulse was received that is of the same polarity as the preceding pulse (excluding B8ZS codewords), thus violating the Alternative Mark Inversion Rule.

**Red Alarm LED** — lit when the receiver has lost frame synchronization for 2 to 2.5 seconds. The LED is extinguished when Frame Sync has been acquired for at least eight consecutive seconds.

**Yellow Alarm LED** — lit while a Yellow Alarm indication is being received from the remote unit. The remote unit will transmit a Yellow Alarm indication while in the Red Alarm state. While operating in D4 framing, the Yellow Alarm condition is transmitted by forcing bit 2 of every DS0 to a zero state. In ESF framing mode, the Yellow Alarm condition is a pattern embedded in the framing overhead.

**Sync LED** — lit when the local unit is in Sync with the remote unit. It is extinguished when synchronization is lost. Frame sync criteria is the receipt of 10 consecutive F bits. Sync loss criteria is receipt of 2 of 4 consecutive frame word errors.

**Test LED** — lit whenever the unit is in a selected diagnostic mode or test, or while the unit is sending diagnostic patterns.

## 2.5 Channel LEDs

The four LEDs below the Channel heading represent the status of the channel side of the unit. The Channel TD (green) LED lights when the channel is transmitting a space. The Channel RD (green) LED lights when the channel is receiving a space. The Request to Send (RTS) LED lights when the Request to Send function is active. The Channel RLSD (green) LED lights when the channel's Receive Line Signal Detect function is active.

## 2.6 Rear-Panel Controls and Interface Connectors

The rear panel (Figure 2-5) provides access to the physical interfaces necessary to connect the unit to a network. Depending on the model, there is one of the following female connectors on the rear panel for the DTE interface: 34-pin M block (V.35), DB37 (RS-449), or DB25 (RS-530). There is also a five-pin DIN power connector for applying logic power (-5 and ±12 VDC) to the unit. There are two DIP switches (Switch 1 and Switch 3), along with the LBO switch (Switch 2).

### NOTE

**When operating as a channel service unit (CSU), the setting of the Line Build-Out function is dictated by the carrier and must be set as the carrier specifies. Otherwise, the LBO Switch must be set to the 0 dB position.**

## 2.7 Channel Interface Connections

T1 CSU/DSU is configured for DTE connection with one of these three interfaces: V.35, RS-449, or RS-530 (female connectors). Below are the pinouts (male connectors) for these interfaces.

### V.35 Pinout (34-pin male connector)

Pin	Function	Pin	Function
A	Ground	T	.RD(B)
D	.CTS	U	.TT(A)
E	.DSR	V	.RT(A)
F	.DCD	W	.TT(B)
P	.SD(A)	X	.RT(B)
R	.RD(A)	Y	.ST(A)
S	.SD(B)	AA	.ST(B)

### RS-449 Pinout (DB37 male connector)

1	Shield	20	.Receive Common
2	.Signal Rate Indicator	21	—
3	—	22	.Send Data (B)
4	.Send Data (A)	23	.Send Timing (B)
5	.Send Timing (A)	24	.Receive Data (B)
6	.Receive Data (A)	25	.Request to Send (B)
7	.Request To Send (A)	26	.Receive Timing (B)
8	.Receive Timing (A)	27	.Clear to Send (B)
9	.Clear To Send (A)	28	.Terminal in Service
10	.Local Loopback	29	.Data Mode
11	.Data Mode (A)	30	.Terminal Ready (B)
12	.Terminal Ready (A)	31	.Receiver Ready (B)
13	.Receiver Ready (A)	32	.Select Standby
14	.Remote Loopback	33	.Signal Quality
15	.Incoming Call	34	.New Signal
16	.Select Frequency	35	.Terminal Timing (B)
17	.Terminal Timing (A)	36	.Standby/Indicator
18	.Test Mode	37	.Send Common
19	.Signal Ground		

### RS-530 Pinout (DB25 male connector)

1	.Shield (A)	14	.Transmitted Data (B)
2	.Transmitted Data (A)	15	.Transmitter Signal Element DCE (A)
3	.Received Data (A)	16	.Received Data (B)
4	.Request to Send (A)	17	.Receiver Signal Element Timing DCE (A)
5	.Clear to Send (A)	18	.Local Loopback
6	.DCE Ready (A)	19	.Request to Send
7	.Signal Ground	20	.DTE Ready (A)
8	.Received Line Signal Detector (A)	21	.Remote Loopback
9	.Receiver Signal Element Timing—DCE (B)	22	.DCE Ready (B)
10	.Received Line Signal Detector (B)	22	.DCE Ready (B)
11	.Transmitter Signal Element Timing—DTE (B)	23	.DTE Ready (B)
12	.Transmitter Signal Element Timing—DCE (B)	24	.Transmitter Signal Element Timing DTE (A)
13	.Clear to Send (B)	25	.Test Mode

# T1 CSU/DSU (V.35, 449, or 530)

## 2.7.1 POWER CONNECTION

The power connector (female) is on the rear panel. The male connector of the DC power supply plugs into this female connector. Figure 2-6 shows the pinout of the 5-pin DIN connector.

## 2.7.2 NETWORK CONNECTION

The network connector is an RJ-48C modular connector with an RJ-48C-to-DB15 pigtail cable (not supplied). Refer to Figure 2-7.

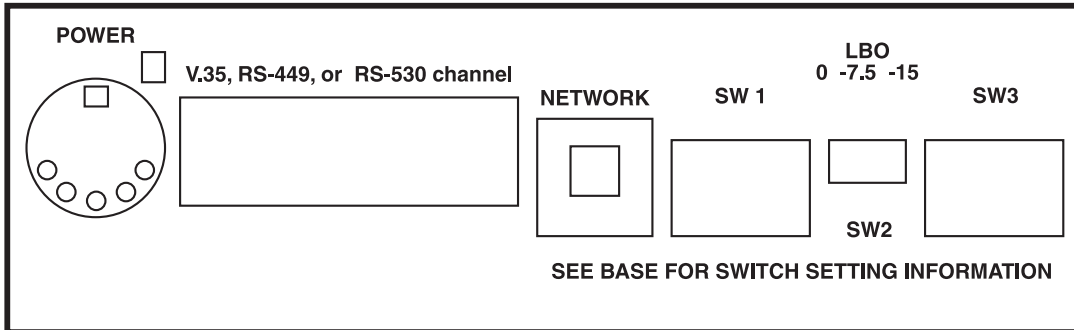

Figure 2-5. Rear-Panel Connections.

## VM Series Regulated Table Top Power Supply

- Pin 1 = Common
- Pin 2 = N/C
- Pin 3 = +5V
- Pin 4 = -12V
- Pin 5 = +12V

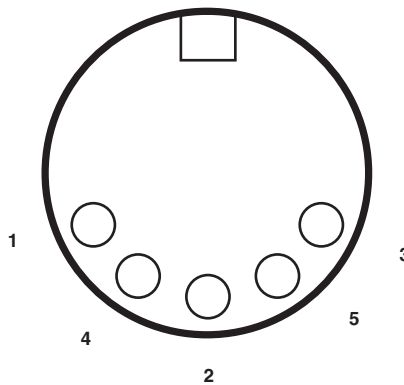
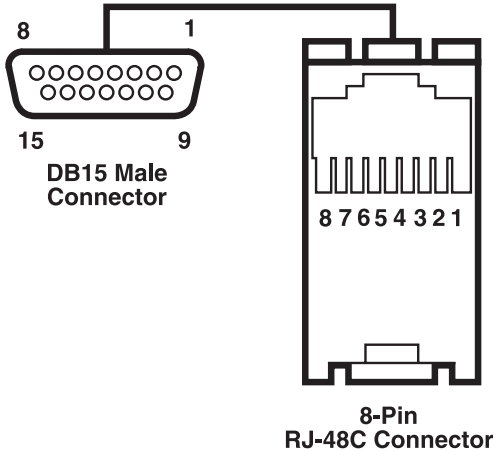

Figure 2-6. Power Connector Pinout.

DB15	RJ-48C	Signal
1	5	TX Tip
3	2	RX Tip
9	4	TX Ring
11	1	RX Ring
2 and 7	7 and 8	Gnd



**Figure 2-7. Network Connector: DB15-to-RJ-48 Pigtail Cable.**

# 3. Installation

## 3.1 Introduction

This chapter has the information necessary to plan, perform, and verify the mechanical and electrical installation of the T1 CSU/DSU. Before installing the T1 CSU/DSU, read and *completely* understand the information presented here.

## 3.2 Site Preparation

The T1 CSU/DSU should be installed within 7 feet (2.1 m) of a grounded AC outlet furnishing 115/230 VAC. The location should be clean, well lit, and conform to the standards for computer equipment installations. Allow a 36-inch (91.4-cm) clearance for both the front and back of the unit for access during operation and maintenance. When connecting the interface cables, allow 4 feet (1.2 m) of slack in the cables so that you can move the unit to perform service without disconnecting the cables.

## 3.3 Installation Procedure

Before installing the T1 CSU/DSU, carefully read and understand the entire installation procedure.

Although we take great care to make sure that the T1 CSU/DSU is properly packaged so that it will not be damaged during transit, it is your responsibility to verify that the unit arrives undamaged. Before unpacking the T1 CSU/DSU, read the following:

1. Carefully remove all packing material from the T1 CSU/DSU.
2. Inspect the equipment for damage that may have occurred during shipment. If any damage is noted, contact the shipping agent and the manufacturer.

### **NOTE**

**The T1 CSU/DSU shipping carton is designed to ensure that the device arrives undamaged. If it ever becomes necessary to move the T1 CSU/DSU to another location, save the shipping carton for such use.**

## 3.4 Equipment Cabling

### 3.4.1 NETWORK CABLING

The Network connector is an RJ-48C modular type connector with an optional RJ-48C-to-DB15 pigtail cable (not supplied). Depending upon the configuration of the network, either connect the network line cable directly into the unit or first connect the RJ-48C-to-DB15 pigtail cable into the unit and then connect the network line cable to the DB15 end of the pigtail cable.

### 3.4.2 DTE CHANNEL CABLING

The T1 CSU/DSU is configured at the factory to be connected via an industry-standard channel interface using either a V.35, RS-449, or RS-530 cable. When the DTE interface cable is in position and seated, secure it with the two jack screws. For information about DTE interface pinouts, see **Section 2.7**.

### 3.4.3 POWER CABLING AND INITIAL POWER UP

## NOTE

**Before connecting the power cable to the T1 CSU/DSU, make sure that the unit is properly configured and all interface cables are connected and seated.**

Power to the T1 CSU/DSU is supplied by a separate DC power supply. Insert the power supply male DIN connector into the female DIN connector at the rear of the unit. Insert the power cable male connector into a grounded AC power receptacle. At this time power is applied to the T1 CSU/DSU.



# 4. Operation

The T1 CSU/DSU is controlled by a series of simple switch settings that the operator can select by accessing Switches one, two, and three at the rear of the unit.

## 4.1 Modify Configuration

To configure a new T1 CSU/DSU Series or modify the configuration of an existing T1 CSU/DSU Series, first determine the correct information by reviewing the following worksheet. This worksheet should be copied and annotated so that when completed it can be saved for future reference.

Before completing the worksheet, you should have a complete understanding of the application being served by the T1 CSU/DSU format processor.

# Configuration Worksheet

**Customer Name:** \_\_\_\_\_

**Date:** \_\_\_\_\_

**Customer Location:** \_\_\_\_\_

**Configuration:** \_\_\_\_\_

## Switch One Settings

1. Data Rate Selection (see Table 4-2) .....S1-1  
 S1-2  
 S1-3

2. DTE Channel Multiples                   N x 56 kbps: .....S1-4: On  
 N x 64 kbps: .....S1-4: Off

Selectable N x 56 Rates:                   8, 16, 24, 32, 40, 48, 56, 64, 112, 168, 192, 224, 280, 320, 336, 448, 560,  
 672, 840, 960, 1120, and 1344 kbps.

### NOTE

For specific speed selection information, refer to Table 4-2.

Selectable N x 64 Rates:                   8, 16, 24, 32, 40, 48, 64, 128, 192, 256, 320, 384, 512, 640, 768, 960, 1280,  
 and 1536 kbps.

### NOTE

For specific speed selection information, refer to Table 4-2.

## T1 CSU/DSU (V.35, 449, or 530)

### 3. Channel Send Timing:

- A. Loop 1 (Terminal Timing) .....S1-5: On
- B. Loop 2 (Send Timing) .....S1-5: Off

### 4. Channel Timing:

- A. Normal .....S1-6: On
- B. Inverted .....S1-6: Off

### 5. Channel Data:

- A. Normal .....S1-7: On
- B. Inverted .....S1-7: Off

### 6. Request To Send Control:

- A. Always On.....S1-8: On
- B. Controlled .....S1-8: Off

### 7. Aggregate Timing Selection:

- A. Internal (Master) Crystal Timing .....S1-9: On  
S1-10: On
- B. Loop (Slave) Timing .....S1-9: Off  
S1-10: On
- C. External Channel Timing (see the Note below) .....S1-9: On  
S1-10: Off
- D. Internal (Master) Crystal Timing .....S1-9: Off  
S1-10: Off

## NOTE

If the External Channel Timing selection is made, then the associated Channel Send Timing must be set to Loop 1 Timing. When operating in this mode, the DCE provides the network timing.

**Switch Two Settings**

1. LBO Setting. (Active only in the CSU mode of operation. When operating in the DSX-1 mode, the LBO switch must be in the 0 dB position.) Position the LBO switch as directed by the carrier:

- A. -1.5 dB
- B. -7.5 dB
- C. 0 dB

**Switch Three Settings**

1. Network Framing:

- A. D4 .....S3-1: On
- B. ESF (Fe) .....S3-1: Off

2. Network Line Code:

- A. AMI .....S3-2: On
- B. B8ZS.....S3-2: Off

3. Network Interface:

- A. CSU .....S3-3: On
- S3-4: Off
- S3-5: On

**NOTE**

If the CSU Mode of operation is selected, then the LBO switch must be set as defined by the carrier. Refer to Switch 2 setting information presented below. If the CSU Mode is selected, then all the DSX-1 selections are invalid. If the unit is not to be operated as a CSU but in the DSX-1 mode, then the Transmit Output Pulse must be defined.

## T1 CSU/DSU (V.35, 449, or 530)

In making the following 5 selections, the operator defines the mode of operation as DSX-1 and also specifies the proper transmit output pulse.

4. Transmit Output Pulse: (DSX-1 Mode Only. If any of the output pulse selections are made, then the CSU selection is invalid. If a DSX-1 Mode is selected, verify that the LBO switch is in the O position.) The Transmit Output Pulse selection is determined by the distance between the unit and the external CSU.

- A. 0 – 133 ft. ....S3-3: Off  
S3-4: Off  
S3-5: On
- B. 133 – 266 ft. ....S3-3: On  
S3-4: On  
S3-5: Off
- C. 266 – 399 ft. ....S3-3: Off  
S3-4: On  
S3-5: Off
- D. 399 – 533 ft. ....S3-3: On  
S3-4: Off  
S3-5: Off
- E. 533 – 655 ft. ....S3-3: Off  
S3-4: Off  
S3-5: Off

5. Density Monitor:

- A. 1 in 16.....S3-6: Off  
S3-7: On  
S3-8: On
- B. 1 in 32 .....S3-6: Off  
S3-7: Off  
S3-8: On

- C. 1 in 48 .....S3-6: Off  
S3-7: On  
S3-8: Off
- D. 1 in 64.....S3-6: Off  
S3-7: Off  
S3-8: Off
- E. None.....S3-6: On  
S3-7: N/A  
S3-8: N/A

**6. Zero Byte Suppression:**

- A. Inhibit.....S3-9: On
- B. Active .....S3-9: Off

**7. DS0 Mapping:**

- A. Contiguous .....S3-10: On
- B. Alternate .....S3-10: Off

**NOTE**

**Refer to Table 4-2 for the information pertaining to the DS0s used with either contiguous or alternate DS0 mapping.**

**When the configuration worksheet is complete and verified, you can configure the unit by simply setting the switches on the rear panel as defined on the worksheet.**

## 4.2 Configuration Tables

When you become proficient with the T1 CSU/DSU's configuration procedures, it may be easier and simpler to use the configuration tables presented below (also available on the bottom of the device) to quickly configure the T1 CSU/DSU Series.

**Table 4-1. Configuration Switch 1 Settings.**

Position	Description	On	Off
1	Data Rate Selection	see Table 4-2	
2	Data Rate Selection	see Table 4-2	
3	Data Rate Selection	see Table 4-2	
4	Rate Multiple	N x 56K	N x 64K
5	Channel Send Timing	Loop 1	Loop 2
6	Channel Timing	Normal	Invert
7	Channel Data	Normal	Invert
8	RTS	On	Controlled
9	Aggregate Timing Selection	see Table 4-3	
10	Aggregate Timing Selection	see Table 4-3	

**Table 4-2. Data Rate Selection and DS0 Allocation.**

Data Rate (kbps)				DS0's Used		
S1-4 On	S1-4 Off	S1-1	S1-2	S1-3	S3-10 On	S3-10 Off
56	64	On	On	On	1	1-2
112	128	Off	On	On	1-2	14
168	192	On	Off	On	1-3	1-6
224	256	Off	Off	On	14	1-8
336	384	On	On	Off	1-6	1-12
448	512	Off	On	Off	1-8	1-16
672	768	On	Off	Off	1-12	1-24
1344	1536	Off	Off	Off	1-24	N/A

**Table 4-3. Aggregate Timing Selection.**

<b>Transmit Timing Reference</b>	<b>S1-9</b>	<b>S1-10</b>
Internal (Master) Crystal Timing	On	On
Loop (Slave) Timing	Off	On
External Channel Timing	On	Off
Internal (Master) Crystal Timing	Off	Off

**Table 4-4. Configuration Switch 3 Settings.**

<b>Position</b>	<b>Description</b>	<b>On</b>	<b>Off</b>
1	Framing Format	D4	ESF (Fe)
2	Encoding Format	AMI	B8ZS
3	Output Pulse	see Table 4-5	
4	Output Pulse	see Table 4-5	
5	Output Pulse	see Table 4-5	
6	Density Selection	see Table 4-6	
7	Density Selection	see Table 4-6	
8	Density Selection	see Table 4-6	
9	Zero Byte Suppression	Inhibit	Active
10	DS0 Mapping	Contiguous	Alternative



**Table 4-5. Output Pulse Selection.**

<b>Line Length Selected</b>	<b>S3-3</b>	<b>S3-4</b>	<b>S3-5</b>
N/A	On	On	On
N/A	Off	On	On
CSU	On	Off	On
DSX-1 0 – 133 ft.	Off	Off	On
DSX-1 133 – 266 ft.	On	On	Off
DSX-1 266 – 399 ft.	Off	On	Off
DSX-1 399 – 533 ft.	On	Off	Off
DSX-1 533 – 655 ft.	Off	Off	Off

**Table 4-6. Density Selection.**

<b>Ratio</b>	<b>S3-6</b>	<b>S3-7</b>	<b>S3-8</b>
1 in 16	Off	On	On
1 in 32	Off	Off	On
1 in 48	Off	On	Off
1 in 64	Off	Off	Off
None	On	N/A	N/A

# Appendix: FCC Documentation Requirements

The following information is required by FCC Part 68 Rules which inform the user of his rights and obligations in ordering service and in connecting this equipment to the network.

This equipment complies with Part 68 of FCC Rules. Please note the following:

1. When you order service, the telephone company needs to know:

a. The Facility Interface Code:

04DU-B (1.544 MB D4 framing format)

04DU9-C (1.544 MB ESF format)

b. The Service Order Code: 6.0F

A signal power affidavit will be required to guarantee encoded analog content and billing protection unless this unit is used in combination with an XD type device or no encoded analog signals and billing information are transmitted. A sample of the affidavit is attached. For most uses, the second box is appropriate.

c. The USOC Jack Required: RJ-48C

In addition, if requested, please inform the telephone company of the make, model and FCC Registration Number, which are on the label.

2. Your telephone company may make changes in its facilities, equipment, operations, or procedures that could affect the proper functioning of your equipment. If they do, you will be notified in advance to give you an opportunity to maintain uninterrupted telephone service.

3. If your telephone equipment causes harm to the telephone network, the telephone company may discontinue your service temporarily. If possible, they will notify you in advance, but if advance notice is not practical, you will be notified as soon as possible. You will be informed of your right to file a complaint with the FCC.

4. If you experience trouble with the telephone equipment, please contact Black Box at 724-746-5500 for information on obtaining service or repairs.

5. You are required to notify the telephone company when this unit is disconnected from the network.

**AFFIDAVIT FOR THE CONNECTION OF  
CUSTOMER PREMISES EQUIPMENT TO  
1.544 Mbps AND/OR SUBRATE DIGITAL SERVICES.**

For work to be performed in the certified territory of

\_\_\_\_\_

(TELCO Name)

State of: \_\_\_\_\_

County of: \_\_\_\_\_

I \_\_\_\_\_,

(name)

(Business Address)

representing \_\_\_\_\_ ( ) \_\_\_\_\_

(Telephone Number)

being duly sworn, state:

I have responsibility for the operation and maintenance of the terminal equipment to be connected to \_\_\_\_\_ 1.544 Mbps and/or \_\_\_\_\_ Subrate digital services. The terminal equipment complies with Part 68 of the Commission's rules except for the encoded analog content and billing protection specifications. With respect to encoded analog content and billing protection:

I attest that all operations associated with the establishment, maintenance, and adjustment of the digital CPE with respect to encoded analog content and encoded billing information continuously complies with Part 68 of the FCC's Rules and Regulations.

The digital CPE does not transmit digital signals containing encoded analog content or billing information which is intended to be decoded within the telecommunications network.

The encoded analog and billing protection is factory set and is not under the control of the customer.

## APPENDIX: FCC Documentation Requirements

I attest that the operator(s)/maintainer(s) of the digital CPE responsible for the establishment, maintenance, and adjustment of the encoded analog content and billing information has (have) been trained to perform these functions by successfully completing one of the following (check all that apply):

a. A training course provided by the manufacturer/grantee of the equipment used to encode analog signals; or

b. A training course provided by the customer or authorized representative, using training materials and instructions provided by the manufacturer/grantee of the equipment used to encode analog signals; or

c. An independent training course (for example, trade school or technical institution) recognized by the manufacturer/grantee of the equipment used to encode analog signals; or

d. In lieu of the preceding training requirements, the operator(s)/maintainer(s) is (are) under control of a supervisor trained in accordance with \_\_\_\_\_ above.

(circle one)

I agree to provide \_\_\_\_\_ with proper documentation to demonstrate compliance with the information as provided in the preceding paragraph, if so requested.

Signature \_\_\_\_\_

Title \_\_\_\_\_

Date \_\_\_\_\_

Subscribed and Sworn to before me

this \_\_\_\_\_ day of \_\_\_\_\_, 20\_\_\_\_\_

\_\_\_\_\_  
*Notary Public*

My commission expires: \_\_\_\_\_



© Copyright 2001. Black Box Corporation. All rights reserved.

---

1000 Park Drive • Lawrence, PA 15055-1018 • 724-746-5500 • Fax 724-746-0746