

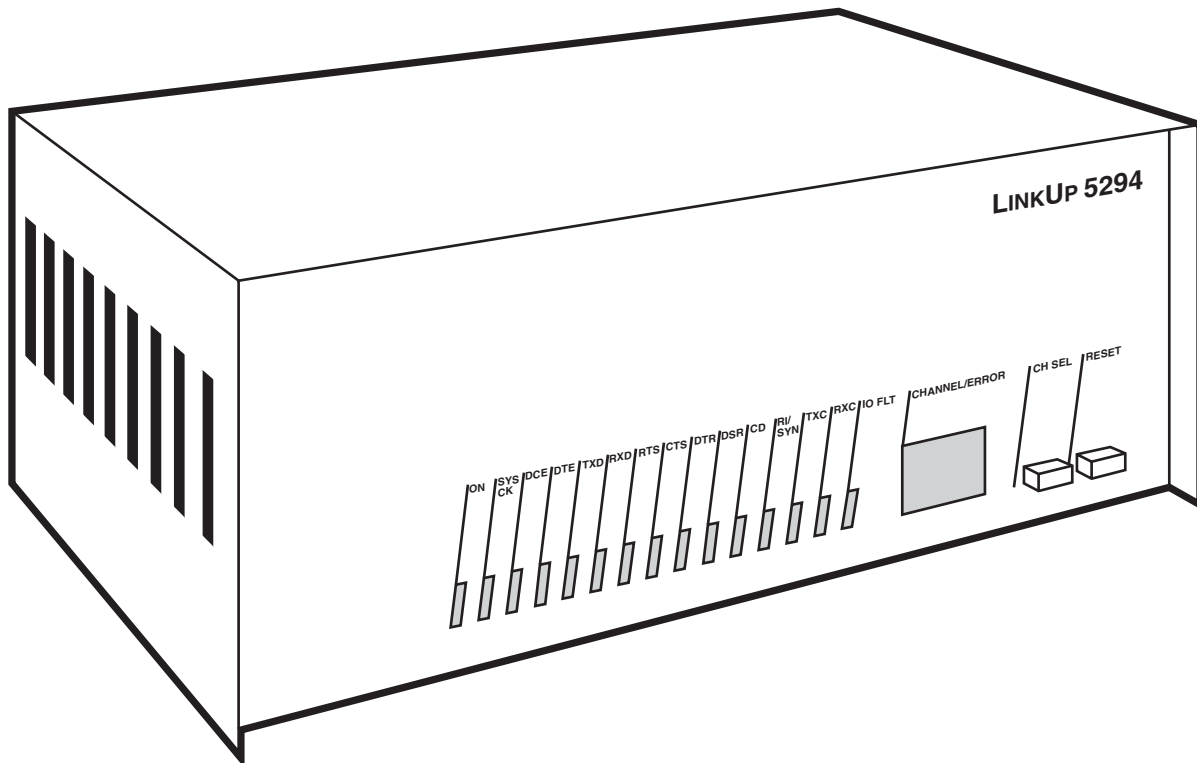

LinkUp 5294 DL5294 Firmware



**CUSTOMER
SUPPORT
INFORMATION**

Order toll-free in the U.S.: Call **877-877-BBOX** (outside U.S. call **724-746-5500**)
FREE technical support 24 hours a day, 7 days a week: Call **724-746-5500** or fax **724-746-0746**
Mailing address: **Black Box Corporation**, 1000 Park Drive, Lawrence, PA 15055-1018
Web site: www.blackbox.com • E-mail: info@blackbox.com

**FEDERAL COMMUNICATIONS COMMISSION
AND
INDUSTRY CANADA
RADIO FREQUENCY INTERFERENCE STATEMENTS**

This equipment generates, uses, and can radiate radio-frequency energy, and if not installed and used properly, that is, in strict accordance with the manufacturer's instructions, may cause interference to radio communication. It has been tested and found to comply with the limits for a Class A computing device in accordance with the specifications in Subpart B of Part 15 of FCC rules, which are designed to provide reasonable protection against such interference when the equipment is operated in a commercial environment. Operation of this equipment in a residential area is likely to cause interference, in which case the user at his own expense will be required to take whatever measures may be necessary to correct the interference.

Changes or modifications not expressly approved by the party responsible for compliance could void the user's authority to operate the equipment.

This digital apparatus does not exceed the Class A limits for radio noise emission from digital apparatus set out in the Radio Interference Regulation of Industry Canada.

Le présent appareil numérique n'émet pas de bruits radioélectriques dépassant les limites applicables aux appareils numériques de la classe A prescrites dans le Règlement sur le brouillage radioélectrique publié par Industrie Canada.

INSTRUCCIONES DE SEGURIDAD (Normas Oficiales Mexicanas Electrical Safety Statement)

1. Todas las instrucciones de seguridad y operación deberán ser leídas antes de que el aparato eléctrico sea operado.
2. Las instrucciones de seguridad y operación deberán ser guardadas para referencia futura.
3. Todas las advertencias en el aparato eléctrico y en sus instrucciones de operación deben ser respetadas.
4. Todas las instrucciones de operación y uso deben ser seguidas.
5. El aparato eléctrico no deberá ser usado cerca del agua—por ejemplo, cerca de la tina de baño, lavabo, sótano mojado o cerca de una alberca, etc..
6. El aparato eléctrico debe ser usado únicamente con carritos o pedestales que sean recomendados por el fabricante.
7. El aparato eléctrico debe ser montado a la pared o al techo sólo como sea recomendado por el fabricante.
8. Servicio—El usuario no debe intentar dar servicio al equipo eléctrico más allá a lo descrito en las instrucciones de operación. Todo otro servicio deberá ser referido a personal de servicio calificado.
9. El aparato eléctrico debe ser situado de tal manera que su posición no interfiera su uso. La colocación del aparato eléctrico sobre una cama, sofá, alfombra o superficie similar puede bloquea la ventilación, no se debe colocar en libreros o gabinetes que impidan el flujo de aire por los orificios de ventilación.
10. El equipo eléctrico deber ser situado fuera del alcance de fuentes de calor como radiadores, registros de calor, estufas u otros aparatos (incluyendo amplificadores) que producen calor.
11. El aparato eléctrico deberá ser conectado a una fuente de poder sólo del tipo descrito en el instructivo de operación, o como se indique en el aparato.
12. Precaución debe ser tomada de tal manera que la tierra física y la polarización del equipo no sea eliminada.
13. Los cables de la fuente de poder deben ser guiados de tal manera que no sean pisados ni pellizcados por objetos colocados sobre o contra ellos, poniendo particular atención a los contactos y receptáculos donde salen del aparato.
14. El equipo eléctrico debe ser limpiado únicamente de acuerdo a las recomendaciones del fabricante.
15. En caso de existir, una antena externa deberá ser localizada lejos de las líneas de energía.
16. El cable de corriente deberá ser desconectado del cuando el equipo no sea usado por un largo periodo de tiempo.
17. Cuidado debe ser tomado de tal manera que objetos líquidos no sean derramados sobre la cubierta u orificios de ventilación.
18. Servicio por personal calificado deberá ser provisto cuando:
 - A: El cable de poder o el contacto ha sido dañado; u
 - B: Objetos han caído o líquido ha sido derramado dentro del aparato; o
 - C: El aparato ha sido expuesto a la lluvia; o
 - D: El aparato parece no operar normalmente o muestra un cambio en su desempeño; o
 - E: El aparato ha sido tirado o su cubierta ha sido dañada.

TRADEMARKS USED IN THIS MANUAL

Apple® and Macintosh® are registered trademarks of Apple Computer, Inc.
Centronics® is a registered trademark of Centronics Corporation.
COMPAQ® is a registered trademark of Compaq Computer Corporation.
Hewlett-Packard®, HP®, and LaserJet® are registered trademarks of Hewlett-Packard.
IBM®, AS/400®, and AT® are registered trademarks of International Business Machines.

Any other trademarks mentioned in this manual are acknowledged to be the property of the trademark owners.

Contents

Chapter	Page
1. Specifications	8
2. Introduction	9
3. Features and Applications	11
3.1 Display Emulation Support	11
3.2 Printer Emulation Support.....	15
3.3 Virtual Device Addressing	18
3.4 User-Friendly Facilities.....	20
3.5 File-Transfer Support	21
3.6 Modify for 3174 Protocol.....	22
3.7 Port Test and System Management Modes	22
3.8 5251/5294/5394 Emulation.....	23
3.9 Additional Features.....	23
4. Hardware Overview.....	24
4.1 Front Panel	24
4.2 Front Panel Controls.....	24
4.3 Channel Status Indicators	25
4.4 System Status Indicators	26
4.5 Error Code Display.....	26
4.6 Rear Panel	26
5. Electrical Characteristics	27
5.1 Power Specifications	27
5.2 Cable Pin Requirements	27
6. Installation	29
6.1 Installing the LinkUp 5294 and the Configuration Terminal.....	29
6.1.1 Unpack the LinkUp 5294	29
6.1.2 Install the LinkUp 5294	29
6.1.3 Set Up the Configuration Terminal	30
6.1.4 Connect the Configuration Terminal	30
6.1.5 Establish Communication	30
6.1.6 Select a Device Type	30
6.2 Accessing the LinkUp 5294 Configurator	31
6.3 Connecting Additional Local Terminals	31
6.4 Connecting Remote Terminals	32
6.4.1 Line Configuration.....	32
6.4.2 Modem Considerations.....	32

Contents (continued)

Chapter		Page
6.5	Connecting Printers.....	32
	6.5.1 Local Printers.....	32
	6.5.2 Remote Printers.....	33
	6.5.3 Auxiliary Printers.....	33
6.6	Connecting the LinkUp 5294 to the Host Computer.....	34
	6.6.1 Requirements.....	35
	6.6.2 Dual Host Installations.....	35
	6.6.3 Establish Communication with the Host.....	36
7.	Operation.....	37
7.1	Operating Requirements.....	37
	7.1.1 Cables and Connections.....	37
	7.1.2 System/3X Host.....	38
	7.1.3 ASCII Terminal.....	38
	7.1.4 Personal Computers and Terminal Emulation Software.....	39
	7.1.5 ASCII Printer.....	39
	7.1.6 Modems.....	39
	7.1.7 Packet Network Terminal Node.....	39
7.2	Connect Mode.....	40
	7.2.1 Sign-On Menu.....	40
	7.2.2 Menu Prompts and Parameters.....	41
	7.2.3 Editing Instructions.....	44
	7.2.4 Error Messages.....	44
7.3	Port Test Mode.....	45
	7.3.1 Port Test Mode Menu and Functions.....	46
7.4	System Management Mode.....	47
	7.4.1 System Management Mode Menu and Functions.....	48
7.5	Configurator Mode.....	54
	7.5.1 Help Messages During Configuration.....	54
	7.5.2 Consistency Checking.....	54
	7.5.3 Overridable Parameters.....	55
	7.5.4 Configurator Mode Commands.....	55
	7.5.5 Configuration Procedures.....	59
	7.5.6 Synchronous Port Parameters.....	59
	7.5.7 Asynchronous Port Parameters.....	61
	7.5.8 Logical Unit Parameters for a Display.....	65
	7.5.9 Printer Logical Unit Parameters for a Printer or Auxiliary Printer.....	70
	7.5.10 Syntax Error Messages.....	73
	7.5.11 Physical Configuration.....	73
7.6	Emulation Mode.....	74
7.7	Setup Mode.....	74

Contents (continued)

Chapter	Page
8. Packet Network Access Applications.....	76
8.1 Terminology	76
8.2 Using the LinkUp 5294 with PDNs	77
8.3 Installation Considerations.....	79
8.3.1 PAD Parameters	80
8.4 Special Operational Considerations	81
8.5 Other Special Considerations	81
8.5.1 Screen Display Errors	81
8.5.2 Data Forwarding to the PAD	81
9. Diagnostics	82
9.1 On-Line Diagnostics.....	82
9.1.1 Front-Panel Error Codes	82
9.1.2 Front-Panel Status Indicators.....	82
9.2 Off-Line Diagnostics	85
9.2.1 Self Diagnostics.....	85
9.2.2 LU and Port Assignment Status.....	85
9.3 Finding and Identifying Problems	86
10. Emulation Capabilities.....	89
10.1 5250 Display Emulation	89
10.2 5250 Keyboard Functions	89
10.3 LinkUp 5294 Extended Keyboard Functions.....	89
10.4 Printer Support: System vs. Local Copy.....	89
11. Hardware and Software Requirements.....	93
11.1 ASCII Terminals	93
11.2 Personal Computers and Word Processors.....	96
11.3 Auxiliary Attached ASCII Printers	97
11.4 Asynchronous Modems.....	99
APPENDIX A: EBCDIC/ASCII Translation Tables.....	100
APPENDIX B: IBM EBCDIC to ISO ASCII Translation Table	117
APPENDIX C: Supported ASCII Devices.....	118
APPENDIX D: System/36 Configuration Guide.....	122
D.1 Communications Line	123
D.2 Remote Controller, Display Stations, and Printers	128
D.3 Changing the Master Configuration Record.....	133
APPENDIX E: System/38 Configuration Guide	136

Contents (continued)

Chapter	Page
APPENDIX F: Terminal Modules and ASCII Terminal Setups	142
F.1 ACT5A Terminal Module - Microcom ACT-5A	143
F.2 ADM11 Terminal Module - Lear Siegler ADM-11	146
F.3 ADM21 Terminal Module - Lear Siegler ADM-21	148
F.4 ADM3A Terminal Module - Lear Siegler ADM-3A.....	151
F.5 ADM3P Terminal Module - Lear Siegler ADM-3A Emulators	154
F.6 ANSI Terminal Module - ANSI Standard 3.64.....	156
F.7 COMPU Terminal Module	158
F.8 C7101 Terminal Module - C. Itoh CIE 7101	159
F.9 C7103 Terminal Module - C. Itoh CIE 7103.....	162
F.10 CY5291 Terminal Module - Cybernex XLB-5291	165
F.11 DISPH Terminal Module - Northern Telecom Displayphone.....	167
F.12 D200 Terminal Module - Data General Dasher 200.....	170
F.13 HP45 Terminal Module - Hewlett-Packard HP-2645	173
F.14 HZ51 Terminal Module - Hazeltine 10/51.....	176
F.15 IQ120 Terminal Module - Soroc IQ-120	178
F.16 I3101 Terminal Module - IBM 3101	181
F.17 I3151 Terminal Module - IBM 3151	184
F.18 I3161 Terminal Module - IBM 3161/3163.....	187
F.19 I3164 Terminal Module - IBM 3164.....	190
F.20 REBUS 3000 Terminal Module - Rebus 3000	193
F.21 SCANS Terminal Module - Tymshare Scanset.....	196
F.22 TV910 Terminal Module - TeleVideo 910.....	199
F.23 TV910P Terminal Module - TeleVideo 910 Plus/912	201
F.24 TV925 Terminal Module - TeleVideo 920/925/950	205
F.25 TV970 Terminal Module - TeleVideo TV-970.....	209
F.26 VIEWP Terminal Module - ADDS Viewpoint/Regent	212
F.27 VP60 Terminal Module - ADDS Viewpoint 60.....	215
F.28 VT52 Terminal Module - DEC VT52.....	218
F.29 VT52X Terminal Module - DEC VT52 Emulators.....	220
F.30 VT100 Terminal Module - DEC VT100.....	222
F.31 VT220 Terminal Module	225
F.32 WY30 Terminal Module - Wyse WY30	228
F.33 WY60 Terminal Module - Wyse WY60	230
F.34 WY60X Terminal Module - Wyse WY60 with Extended Keyboard	230
F.35 WY100 Terminal Module - Wyse WY100	233
F.36 XT100 Terminal Module	236

1. Specifications

- Protocol** — SNA/SDLC
- Speed** — 100 bps to 19.2 kbps; Autobaud (300–9600) standard
- Emulation** — Controller: IBM® 5251 M12, 5294, and 5394
- Indicators** — Channel/Error display; Power monitor; System OK LED;
Channel Status LEDs: DCE, DTE, TXD, RXD, CTS, DTR, CD, TXC, RI/SYN,
RXC I/O FAULT
- Interface** — To host: synchronous RS-232C/V.24, DTE or DCE selectable;
To users: asynchronous RS-232C/V.24 or RS-530, DTE, DCE, or auto-selectable
- Connectors** — Host: DB25 female to user's DB25 female or DB9 male
- Power** — 115 or 230 VAC, switch-selectable, 50 or 60 Hz, 50 watts
- Size** — 6"H x 16.8"W x 11"D (15.2 x 42.7 x 27.9 cm)
- Weight** — 17 lb. (7.7 kg)

2. Introduction

The LinkUp 5294 is one of the most feature-rich protocol converters on the market today. For example, it supports the following:

- IBM PC to System/3X file transfers
- Up to 19.2K baud rate, synchronously and asynchronously
- Dual System/3X hosts
- Packet Data Network Access
- Viral Device Addressing
- Auxiliary printing
- Advanced diagnostic and system information functions

Functionally, the LinkUp is designed to convert an IBM System/3X host's synchronous (SNA/SDLC) protocol to asynchronous (and vice versa). It also translates the IBM host's EBCDIC code to ASCII (and vice versa). To accomplish these tasks, it emulates an IBM 5251 Model 12 Remote Workstation Controller, a 5294 Remote Cluster Controller, or a 5394 Remote Cluster Controller. PU Type 1 is implemented by the LinkUp in all emulations.

The LinkUp attaches to the sync communications adapter on your System/34/36/38 or AS/400. It can be directly (with just an RS-232 cable) or remote (through synchronous modems).

Once you make the connections, the LinkUp enables almost any ASCII terminal or personal computer (with the appropriate terminal-emulation software installed) to appear to the IBM host as an actual 5251 Model 11, 5291, or 5292 Display Workstation, implemented as LU Type 7. It also lets almost any ASCII printer to appear to the IBM host as an actual 5224, 5225, or 5256 Printer Workstation, implemented as LU Type 4. Each of these ASCII devices can be directly or remotely connected through asynchronous modems.

Figure 2-1 shows a typical LinkUp 5294 application.

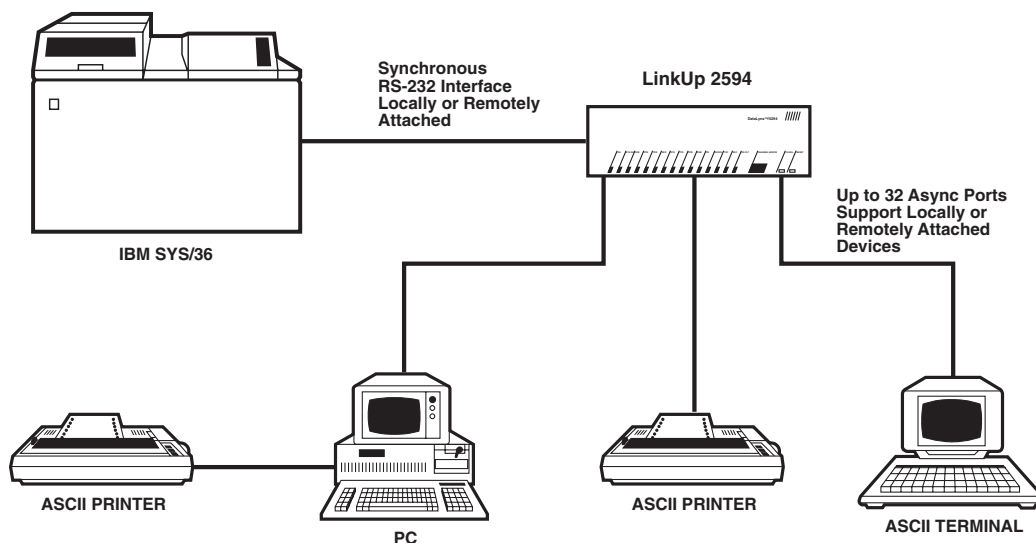

Figure 2-1. A Typical Application of the LinkUp 5294.

The base model is equipped with a minimum of two sync ports, and can be easily upgraded in increments of four or eight ports, until a maximum of 34 (numbered 0 through 33) are installed. Call your supplier to find out how to order this upgrade when you wish to expand the number of connectors on your LinkUp unit.

NOTE

Port 0 and Port 1 support synchronous transmissions. Ports 2 through 33 support asynchronous transmissions.

The following manuals may prove useful during the installation and operation of the LinkUp 5294.

- IBM 5250 Information Display System Functions Reference
- IBM Synchronous Data Link Control General Information
- IBM Systems Network Architecture Concepts and Products

3. Features and Applications

This chapter covers the features and applications of the LinkUp 5294.

3.1 Display Emulation Support

The LinkUp 5294 enables almost any ASCII terminal or personal computer and word processor (with the appropriate terminal emulation software installed) to appear to your System/3X host as an actual 5251 Model 11, 5291, or 5292 Display Workstation. It accomplishes this through a variety of Terminal Modules.

A Terminal Module is a device driver which is designed after a specific ASCII terminal type, with some of the terminal type's unique features incorporated into the module in order to optimize its performance.

NOTE

Any terminal (or terminal emulation software) capable of simulating the terminal type of a specific module can also be supported by that module. See Appendix D for a complete list of the various terminals, personal computers, and word processors currently supported by the LinkUp 5294.

Each Terminal Module has a full implementation of all of the 5250 screen handling facilities, such as attributes and cursor positioning, and most of the keyboard functions. The specific display attributes supported by the LinkUp include the following:

- Reverse Image
- Column Separator
- Non-display
- High-Intensity
- Blink
- Underscore

Any combination of these is also possible.

However, these facilities are supported only as well as the terminals in your application support them. In other words, if the terminal in your application does not support one of the listed attributes, the LinkUp 5294 cannot implement that attribute for the terminal.

Another feature is Screen Optimization. Instead of clearing and repainting a terminal's screen of data for every new update, the LinkUp simply repaints the terminal's screen with only the updated new characters, keeping the amount of screen painting to a minimum.

Each of the 5250 keyboard functions supported by the LinkUp Terminal Modules has been implemented in a manner most suited to the keyboard layout of the particular terminal that the module is designed after. The supported 5250 functions are listed below:

CURSOR MOVEMENT

- Character Backspace
- Cursor Up
- Cursor Down
- Cursor Left
- Cursor Right
- Field Advance
- Field Backspace
- New Line
- Fast Left
- Fast Right

SPECIAL CONTROL

- Error Reset
- Insert
- Delete
- Erase Input
- Home

FIELD EXIT

- Duplicate
- Field Minus
- Field Plus
- Field Exit

SPECIAL HOST

- System Request

SIGNAL

- Attention

AID GENERATING

- Enter
- Clear

- Help
- Print
- Roll Up
- Roll Down
- CMD 1
- CMD 2
- CMD 3
- CMD 4
- CMD 5
- CMD 6
- CMD 7
- CMD 8
- CMD 9
- CMD 10
- CMD 11
- CMD 12
- CMD 13
- CMD 14
- CMD 15
- CMD 16
- CMD 17
- CMD 18
- CMD 19
- CMD 20
- CMD 21
- CMD 22
- CMD 23
- CMD 24

NOTE

Appendix F lists all the currently supported terminal modules and the unique key sequences assigned for each of their supported 5250 functions.

In addition to the standard 5250 keyboard functions supported by the LinkUp 5294, the following eight extended functions are provided:

- **Local Copy Print Request** — prints the contents of your screen to a printer configured and assigned to a terminal (or terminals) as a Local Copy printer.
- **Local Copy Form Feed** — sends a form-feed command to the printer configured and assigned to a terminal (or terminals) as a Local Copy printer.
- **Cancel Print** — cancels a print request sent to a printer configured and assigned to a terminal (or terminals) as a Local Copy Printer.
- **Refresh Screen** — redisplay the last transmitted CRT screen on the screen buffer stored within the LinkUp 5294. This key is useful when a terminal's display is garbled by line errors.
- **Toggle Status Line/Toggle Indicators** — toggles the display of the status indicators generated by the LinkUp to Row 24 of a terminal's screen.

- **Toggle Echoplex Enabled** — toggles the ability of the LinkUp 5294 to echo characters to a terminal's screen. This function will wait only if you configure it as such in the LinkUp Configurator Mode.
- **Initialize Terminal** — causes a terminal to reinitialize without resetting the LinkUp port to which the terminal is attached. You are exited from the System/3X host session (referred to as Emulation Mode) and returned to the LinkUp sign-on menu (called Connect Mode) even if the LinkUp 5294 has been configured to prevent access to this operating mode. When this function is invoked, the host is informed that the workstation's power has been turned off.
- **Request Disconnect** — similar to Initialize Terminal in that it exits you from the System/3X host session (Emulation Mode). However, unlike Initialize Terminal, it will reset the LinkUp port to which the terminal is attached. The LinkUp resets its port by dropping DTR if it is configured as a DTE interface or DSR if it is configured as a DCE interface. When a terminal is remotely connected to the LinkUp by asynchronous modems, this function will cause the modem to hang up. And like Initialize Terminal, this function informs the host that the workstation's power is off.

Another LinkUp feature is a Status Line of five indicators displayed on row 24 of an attached terminal while it is operating in Emulation Mode. The LinkUp displays this line the first time a terminal enters Emulation Mode; thereafter, you may toggle it on or off with the key sequence corresponding to the extended function of Toggle Status Line/Toggle Indicators. These indicators are listed below:

- **SYS AVAIL:** — System Available indicator is set (turned on) whenever the terminal is receiving polls from the System/3X host.
- **MSG WT:** — Message Waiting indicator, controlled by the host, is set whenever you have messages waiting to be read.
- **INS MODE:** — Insert Mode indicator is set whenever [INSERT] is pressed. Insert Mode can be reset (turned off) by pressing the [ERROR RESET] or one of the Aid Generating keys.
- **INPUT INH:** — Input Inhibited indicator is set after an Aid Generating key is pressed. This indicates the keyboard has been locked by the host and you should not type any data. The System/3X host will reset this indicator after it has completed the requested data processing. (Operator errors will also cause this to be set.) Only System Request and Attention keys are valid while input is inhibited.
- **AWFER:** — A Waiting Field Exit Required indicator is set when data is entered into the last position of a field the host has marked as requiring the function of Field Exit to be invoked. It is reset once the field is exited. (On an actual IBM workstation, the cursor blinks to indicate AWFER).

Support for a 25th line Status Line display is available for the following terminals: Hazeltine Esprit 10/51, Lear Siegler ADM-11, TeleVideo 925, Wyse 30, Cyberne XLB-5291, Rebus 3000, and FileLynx/5251. The status display is exactly the same as it had been on line 24, and the Toggle Status Indicators keystroke is accessed in the same manner.

Because of design characteristics of the Wyse 30 and the Cybernec XLB-5291, the ERROR nnnn-mmmm portion of the Status Line in columns 64 through 79 of the 25th line is sometimes unable to display at the proper time. As this part of the Status Line is displayed only in the event of an error between the LinkUp and the System/3X, this limitation should be of little or no consequence to you.

NOTE

If the host or terminal attempts to write data to Row 24 while the Status Line is on, the LinkUp automatically toggles the Status Line off and displays the data.

3.2 Printer Emulation Support

The LinkUp 5294 enables almost any ASCII printer to emulate IBM 5224, 5225, or 5256 Printer Workstations via its 12 distinct Printer Modules. Eleven of the Printer Modules are designed for specific ASCII printer types. They Make use of particular features of the printers so as to optimize the module's performance. The twelfth module is a generic PRINT module.

NOTE

Any printer that can emulate a printer supported by one of the Printer Modules can also be supported by that module, but the support is only as good as the emulation. See Appendix C of this manual for a list of the various printers currently supported by the LinkUp.

The LinkUp does not currently support all SCS commands. See the Table 3-1 for a description of which printer module supports which SCS commands.

Table 3-1. Supported SCS Commands.

HEX SEQUENCE	SCS COMMAND NAME
0C	Form Feed
0D	Carriage Return
15	New Line
1E	Inter Record Separator
25	Line Feed
2B C1...	Set Horizontal Form
2B C2...	Set Vertical Form
2B C6...	Set Line Density
2B D2...	Set Character Density
34 4C...	Relative Vertical Move
34 C0...	Absolute Horizontal Move
34 C4...	Absolute Vertical Move
34 C8...	Relative Horizontal Move
35...	Transparent

The following printer modules support the SCS commands listed above:

- CENTRN
- CI300
- DP8050
- EPSON
- GE3000
- GEN34
- GEN44
- HPDPL

- HPDPP
- HPGEN
- OKIM84
- PRINT

NOTE

Because of a design characteristic of the Genicom® and GE3000 printers, the LinkUp must select a character font at the same time it sets character density (10 cpi vs. 15 cpi). As character fonts are not otherwise selectable in LinkUp, whenever it receives a Set Character Density command from the System/3X host the LinkUp sets the GEN34, GEN44, or GE3000 printer to the DP (draft quality) font. If another font is desired, it must be selected manually and the LinkUp must not be sent an SCD command.

The PRINT printer module does not support Set Line Density or Set Character Density.

For those printer modules which support 15 characters per inch character density, the LinkUp can be set, through SCS commands, to support 198 column printing regardless of what line length is configured in the printer LU. The SCS commands can override the configuration.

Once the appropriate configuration parameter values are defined, the LinkUp can support a printer by three different connections:

1. When the printer is directly connected to one of its asynchronous ports.
2. When the printer is remotely connected to one of its ports through asynchronous modems.
3. When the printer is sharing one of its ports with a directly or remotely connected terminal, personal computer, or word processor, through the terminal's auxiliary port.

Situation #3 is called the Auxiliary Printer facility of the LinkUp 5294. See Figure 3-1 for a diagram of this facility.

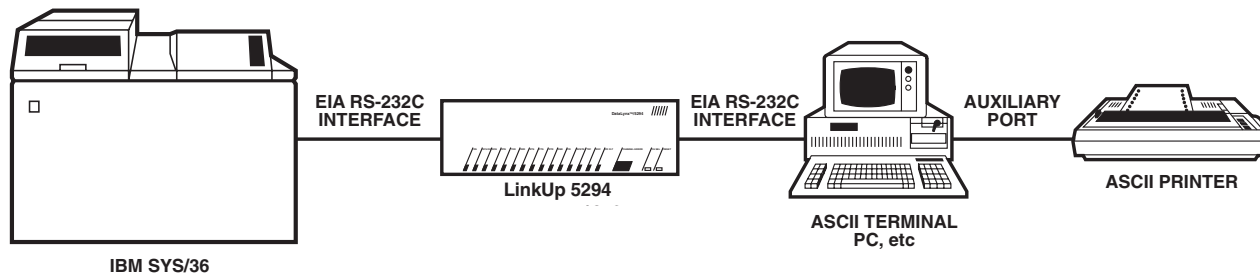

Figure 3-1. Auxiliary Printer Facility.

When this facility is activated, a printer attached to a terminal's auxiliary port is addressed by your System/3X host (and the LinkUp) as if it were attached by its own distinct line, with full System/3X printer emulation capabilities. The difference between a printer attached to its own LinkUp asynchronous port and one sharing a port with a terminal through the terminal's auxiliary port is the process of interleaved printing—two devices sharing a single port are operated concurrently and are instructed by the LinkUp to alternate, with the terminal having priority over the printer.

A choice of two distinct printer operating modes can be defined in the LinkUp Configurator Mode:

- System printing
- Local Copy printing

A System printer is one that accepts print jobs from the System/3X host. A Local Copy printer is one which accepts a command from you to print the contents of a terminal screen. To invoke a local copy print request, you must press the key sequence (appropriate for the selected Terminal Module) corresponding to the extended function of Local Copy Print Request.

NOTE

If the following conditions are not met, a Local Copy Print Request will be ignored and no error message will display.

The printer must be defined in Configurator Mode as LOC, indicating a Local Copy printer.

The printer must be associated, through Configurator or Connect Mode, to the terminal attempting to invoke the Local Copy Print Request function.

The printer must not be currently printing another terminal operator's screen (as it is possible to assign the same printer to more than one terminal operator).

If transparent transmission of Escape sequences to ASCII devices is desired, the LinkUp will translate EBCDIC Hex BB to ASCII Hex IB (Escape) for this purpose when using the US character set.

The LinkUp supports the System/3X host's printer SIGNAL requests:

- printer intervention required
- printer component available

“Printer intervention required” is sent by the LinkUp when a Printer Workstation goes off-line; for example, if the power is turned off or paper runs out. When this SIGNAL is received by the host, the print job is halted. Once the printer is restored to an on-line state, the LinkUp sends “printer component available” to the host, which causes the host to start the interrupted print job from where it left off. This procedure assures you that no loss of data occurs.

When a printer is connected to the LinkUp by its own port and its connect mode parameter has been configured as dedicated, the device ready signal (specified in Configurator Mode) is used by the LinkUp to determine when to send the SIGNALs. However, when its connect mode parameter has been configured for automatic answering, the LinkUp is unable to implement this facility. This is because, when the device ready signal drops, the LinkUp disconnects the device from its coupled session.

NOTE

The printer attached to the LinkUp must be obtained so that its device ready signal matches the value configured in the LinkUp.

The conditions under which the LinkUp implements printer SIGNALs for an auxiliary printer are different. Since an auxiliary printer is connected to the LinkUp by a terminal, it cannot directly communicate with the LinkUp—it must rely on the auxiliary port provided by the terminal it is attached to. Therefore, if the terminal cannot relay to the LinkUp the auxiliary attached printer's off-line and on-line states, the printer is restricted to following the off-line and on-line transmissions of the terminal.

3.3 Virtual Device Addressing

With “Virtual Device Addressing,” the LinkUp is able to support as many as 32 distinct devices. Virtual device addressing allows the LinkUp to recognize each device that attaches to one of its ports through a logical address; or, in other words, logical unit or LU number.

A logical unit and a physical asynchronous port are said to be coupled after you complete signing on to the LinkUp during Connect Mode. However, being physically connected to Port 3 does not mean you have to specify LU 3 as your assigned logical unit. Instead, by virtual device addressing, the LinkUp allows you (and your terminal operators, providing you do not configure the asynchronous port's associated logical unit as non-overridable) to specify any one of the 32 supported LinkUp LUs (provided you have configured all of them as valid in your application).

Conversely, a logical unit and an asynchronous port are said to be decoupled when a physical or logical disconnection occurs between the attached ASCII device and the LinkUp. For example, the LU and port are decoupled when your communication line drops, or when the LinkUp times out after the configured Inactivity Time Limit is reached. If a logical unit and an asynchronous port are decoupled, then the formerly coupled LU can be accessed from another physical port; or another LU can be coupled at the same physical port. In Figure 3-2, several diagrams are provided to show these various LU-port coupling options.

NOTE

Establishing a communication link with your System/3X host for each of these LUs means you must define a workstation identification number (also called a local session ID or LSID), recognized as viable by your host, to each LinkUp LU. This is done by entering your host's LSID to the LinkUp configuration parameter of Local Station Address.

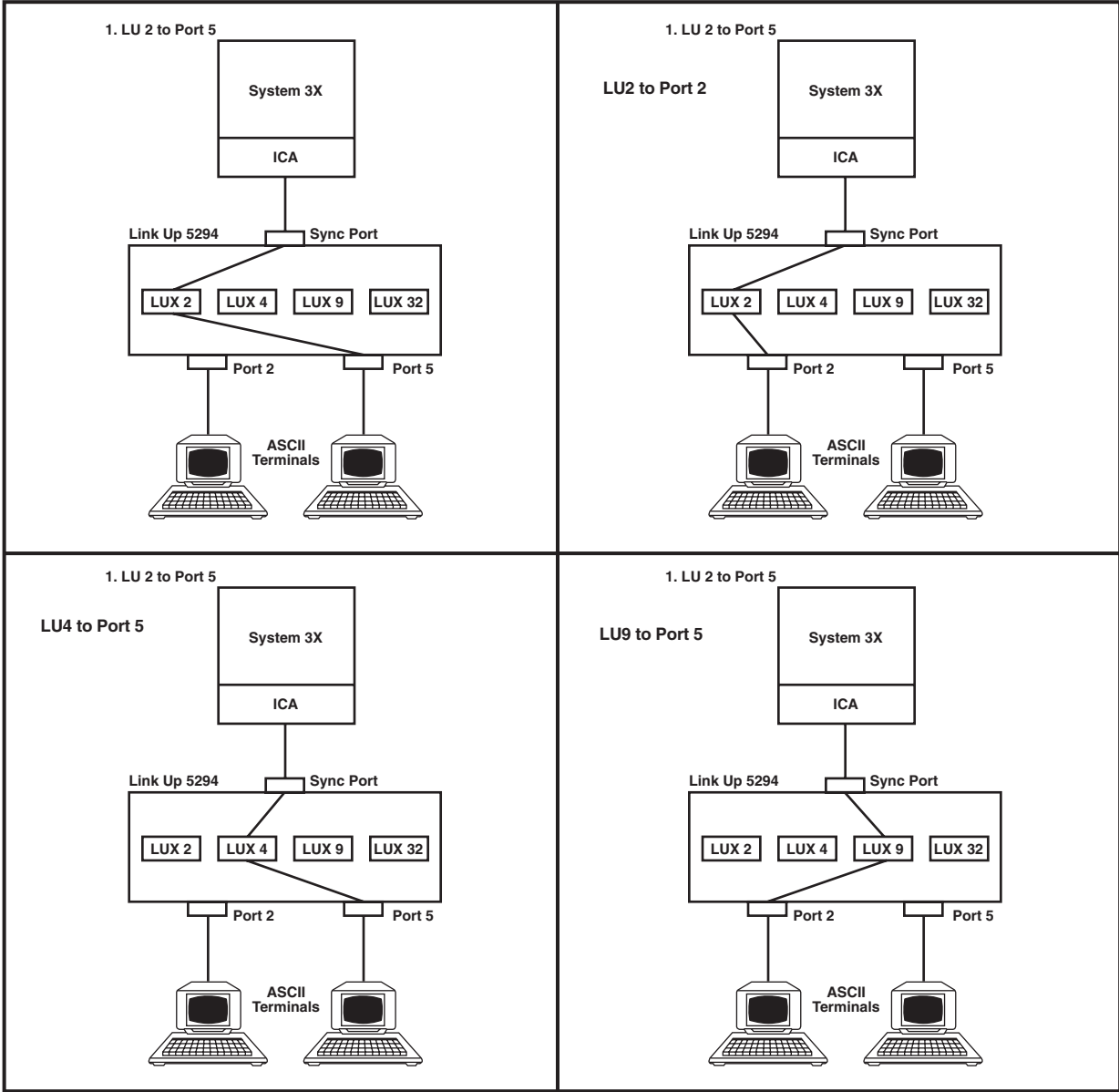

Figure 3-2. Logical Unit to Physical Port Coupling Options.

LINKUP 5294 WITH DL5294 FIRMWARE

The virtual device addressing concept also enables the LinkUp to support its Auxiliary Printer facility. Once the appropriate configurations are made in the LinkUp, a terminal connected to an asynchronous port can sign on to the LinkUp (at Connect Mode), specify an LU associated with an auxiliary printer LU, and have both devices supported on that single port. See Figure 3-3 for a diagram of this feature.

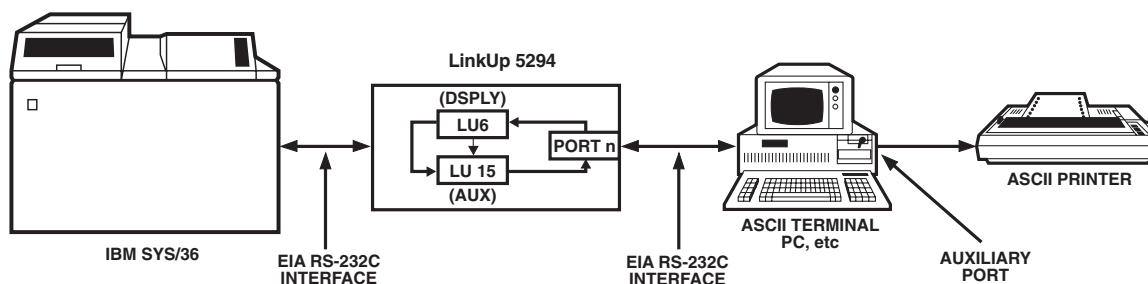

Figure 3-3. Dual LU to Single Physical Port Coupling.

3.4 User-Friendly Facilities

The LinkUp is designed to be user-friendly. You should have very little, if any, difficulty operating it. Here are some of the facilities that make the LinkUp 5294 easier to operate:

- A Menu-Driven Configurator Mode, enabling you to define a variety of operational parameters by menu selections. These define the operating characteristics of the LinkUp's synchronous and asynchronous ports, logical units, and attached devices.
- Help Messages are available at each of the LinkUp operating mode menu prompts (including Connect, Configurator, and Setup) whenever you type a <?> in response to the prompt.
- Non-volatile Electrically Erasable PROM (EEPROM) storage of every parameter value you define in Configurator Mode. This enables the LinkUp to retain your configured values even when its power is turned off.
- Password protection for Configurator Mode, preventing anyone from accessing it and redefining the LinkUp parameter values unless authorized with the correct password.
- Operating and Channel Status Indicators on the front panel of the LinkUp unit. These let you monitor your unit's overall system health and the crucial RS-232C line signals for any port.
- Self-testing performed continuously in the background throughout daily operations. This assures you that the LinkUp is effectively executing its operating programs.
- Automatic baud detection lets the LinkUp automatically detect the incoming baud (or bit) rate of the device you have attached to its asynchronous port.
- An Inactivity Time Limit can be set in Configurator Mode. This enables you to define a maximum amount of time for the LinkUp to maintain the coupling between your terminal, while it is inactive, and its associated LU session.
- A Reconnect Time Limit can also be set in Configurator Mode. This time limit enables the LinkUp to maintain the coupling between a disconnected terminal and its associated LU session. It lets you reconnect and pick up from where the session was interrupted.
- Two-level password protection can be defined for each LinkUp LU whenever you define a Connect Mode password in Configurator Mode. The first level allows the LinkUp to restrict access to an LU from everyone except the one authorized with the correct password. The second one limits access to an interrupted LU session from everyone except the one who initially established the session.

3.5 File-Transfer Support

The LinkUp can support file transfers between a System/3X host computer and an ASCII micro, mini, or instrumentation computer, providing the appropriate host and ASCII computer communication and transfer programs are installed. If the ASCII computer is an IBM Personal Computer (or compatible), four software package combinations currently available in the market can be used with the LinkUp:

- FileLynx®/5251 PC* and Emulator Transfer Utility by SSI
- TruLynx®/5251 PC and Emulator Transfer Utility by SSI
- TruLynx/5251 PC and Emulator Transfer Utility by IBM
- TruLynx/5251 PC and PC Support by IBM

*FileLynx/5251 PC can also transfer files without the assistance of a host package by a simple screen-by-screen process. Consult your supplier for more information on the various capabilities of this software package.

NOTE

PC Support/400 is not supported on the LinkUp 5294.

However, if the ASCII computer is not IBM compatible, you must provide your own communication and transfer programs for both your 3X host and the ASCII computer. In support of such an application, the LinkUp 5294 provides the COMPU Terminal Module. COMPU was designed especially for a computer-to-computer transfer, and as such differs from the other Terminal Modules in the following ways:

1. Data alone is transmitted; for example, no intensity or cursor-positioning sequences are ever sent, even if your 3X host requests them. This process enables the LinkUp 5294 to convert and pass on the transferred data in the same order it was received.
2. Screen optimization is not performed; instead, the LinkUp completely updates a screen full of data each time an update is required. (Usually, the LinkUp updates a screen of data by repainting only the new data and clearing any old data not similar to the new data.)
3. Transferred data is completely buffered by the LinkUp 5294, enabling a continuous transmission of data. Typically the 3X host inhibits transmission when it is processing received data by inhibiting your keyboard input; normally, the LinkUp 5294 adheres to this procedure and ignores any keyboard input you attempt.

NOTE

The COMPU module relies on the normal ASCII-to-EBCDIC and EBCDIC-to-ASCII translations of the data handled by the LinkUp. Additionally, the key sequences defined for its emulation keyboard functions are identical to those used for the ADM3A Terminal Module.

3.6 Modify for 3174 Protocol

The DL5294 Firmware (PCM91) differs from the STD 3174 Firmware (PCM92) in the following aspects only:

- PROM cartridge (the installed firmware)
- Internal EEPROM format
- Amount of RAM installed
- Silkscreened name on front panel of unit

Your LinkUp 5294 with DL5294 Firmware can be modified to support the 3174 protocol by doing the following:

- Ordering the appropriate conversion kit from your supplier.
- Replacing and/or installing the respective parts (in accordance with the kit's provided instructions).
- Invoking Setup Mode (explained in **Section 7.7**).

3.7 Port Test and System Management Modes

These two modes perform a variety of valuable diagnostic and information functions. Port Test Mode consists of the following:

- Interface Signal Display (your port only)
- Character Display Test
- Character Echo Test

System Management Mode consists of the following:

- Interface Signal Display (any LinkUp 5294 port)
- Sync Port Address Trace
- Async Port Trace
- Product Configuration and Levels display
- Sync Port Trace
- Character Display Test (the same as in Port Test Mode)
- Character Echo Test (the same as in Port Test Mode)
- LU and Async Port Summary
- Remote Reset
- SNA/SDLC Counters

Port Test Mode is covered in **Section 7.3**. System Management Mode is covered in **Section 7.4**.

3.8 5251/5294/5394 Emulation

With 5251, 5294, and 5394 controller emulation, the LinkUp 5294 can be configured to emulate two different controllers concurrently on the LinkUp 5294's two synchronous ports. In other words, both ports can be configured to emulate either a 5251 Model 12 or a 5294 or 5394 controller, or one port can be configured to emulate a 5251 Model 12 while the other emulates either a 5294 or 5394.

NOTE

Some capabilities of an actual 5294 or 5394 controller are not fully supported by the LinkUp 5294. For example, Text Assist is not implemented; therefore, DisplayWrite is not supported. Consult your supplier for more information on those capabilities not supported.

3.9 Additional Features

- The LinkUp 5294 can be programmed for up to four controller emulations on one synchronous port (or a maximum of four across the two synchronous ports).
- Five additional functions in System Management Mode (see **Section 3.7** above for a description).
- 5394 Controller emulation.

When the capability of Four Controller Emulations Per One Synchronous Port is implemented, the LinkUp 5294 appears to your host as if it were up to four distinct controllers (each with its own System/3X controller address) on a multipoint line. The LinkUp 5294 supports this facility by mapping each of the 3X controller addresses to the appropriate controller emulations by a logically defined Link Station Address (identified as Links 0, 1, 2, and 3). If so configured, the LinkUp 5294 can emulate as many as four distinct controllers across its two synchronous ports, in any combination (four addresses on one port and none on the other, or three on one port and one on the other, etc.). See **Section 7.5**.

Operating a single LinkUp 5294 as multiple controllers requires that you divide the virtual device addresses (logical units) among the controllers (identified as link station addresses). If your application uses this capability, keep the following limitations in mind:

1. An IBM System/3X will activate at most nine logical units when connected to a 5251 Model 12 controller, only eight logical units when connected to a 5294 controller, or as many as 16 logical units when connected to a 5394 controller.
2. The LinkUp 5294 can emulate up to four controllers simultaneously; those four may be a mix of 5251-12, 5294, and 5394 emulations.
3. Because it has a maximum of 32 logical units available, the LinkUp 5294 can have attached and active at most 32 of the 36 logical units (nine LUs per controller times four 5251-12 controllers) available to your host(s) if emulating 5251-12 controllers. Similarly, only 32 of the possible 64 logical units (sixteen LUs per controller times four 5394 controllers) may be active during 5394 emulation.

When emulating 5294 controllers, the LinkUp can have all 32 of the host's logical units attached and active.

4. Hardware Overview

This chapter discusses the LinkUp 5294's hardware components and capabilities.

4.1 Front Panel

The front panel of the LinkUp 5294 is shown in Figure 4-1. Status indicators monitor power and RS-232C line signals on the selected channel. Two user controls are provided for easy operation.

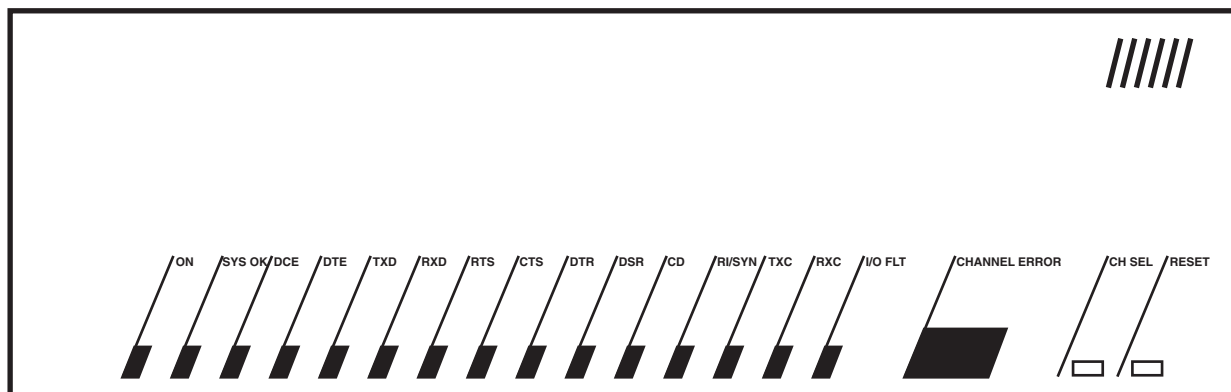

Figure 4-1. LinkUp 5294 Front Panel.

4.2 Front Panel Controls

Two front panel controls are provided on the LinkUp 5294: the CH SEL button and the RESET button. Each of these controls is discussed below.

- **CH SEL (Channel Select) Button** — The CH SEL button is used to select the channel to be monitored. When the button is pressed, the channel number increases. When held for a longer time, the channel number is incremented at a faster rate. The channel being currently monitored is indicated by the two-digit LED display.

If the channel number is incremented past the highest channel available in the unit, 88 appears in the display and an LED integrity test is performed. All of the front panel lights are turned on to ensure proper operation. Pressing the CH SEL button again terminates the LED test.

- **The RESET Button** — The RESET button is used to clear error codes from the front panel display. Error codes are listed in of **Section 9.1**. When the first error occurs, pressing RESET clears the error and channel status display resumes. If there is more than one error, the RESET button clears the most recent error and displays the previous one. When all of the accumulated errors have been displayed and cleared, the status lights resume their normal function. Once cleared, errors cannot be redisplayed using the front panel. Therefore, you should write down any error codes that are displayed before you press RESET.

4.3 Channel Status Indicators

The LinkUp 5294 is equipped with a full RS-232C status display capable of monitoring the status of any selected port. Each of the indicators is briefly described below. ON indicates that the LinkUp 5294 is either transmitting or receiving the signal as appropriate.

- **DCE/DTE (Data Communications Equipment/Data Terminal Equipment)** — An LED lit for one of these indicates that the port selected has been software-optional to communicate with either a modem (DTE) or directly to a terminal or printer (DCE).
- **TXD/RXD (Transmit Data/Receive Data)** — These are data signals that indicate transmission of data either to or from the LinkUp 5294.
- **RTS (Request to Send)** — The LinkUp 5294 provides this signal when optioned as DTE or when it expects to receive the signal when optioned as DCE.
- **CTS (Clear To Send)** — The LinkUp 5294 provides this signal when optioned as DCE and expects it from the modem when optioned as DTE.
- **DTR (Data Terminal Ready)** — The LinkUp 5294 provides this signal when optioned as DTE or expects to receive the signal when optioned as DCE. Additionally, when configured as DTE auto-answer, this signal will be provided only after receipt of the RI (Ring Indicator) signal from the modem.
- **DSR (Data Set Ready)** — The LinkUp 5294 provides this signal when optioned as DCE or expects to receive it from the modem when optioned as DTE.
- **CD (Carrier Detect)** — This LED is lit when the LinkUp 5294 has detected a carrier signal from a remote modem. If no detectable carrier signal is present, or the remote modem hangs up, this LED is turned off.
- **RI/SYN (Ring Indicator/Data Sync)** — This is a dual-function LED. It displays Ring Indicate when the selected port is optioned as DTE/auto-answer in synchronous or asynchronous operation. On the sync port, this LED is always off.
- **TXC/RXC (Transmit Clock/Receive Clock)** — When on, this LED indicates the presence of synchronous clock signals which are required for the sync port. These must always be present for Port 0 and Port 1.
- **I/O FAULT** — On SYNC ports, this LED flashes if a framing error occurs. On asynchronous ports this LED indicates parity errors.

During normal operation in async DTE mode, the following should be on:

DTE, RTS, CTS, DSR and CD

RI will be on during ringing, and DTR will come on after RI is detected.

During normal operation in async DCE mode, the following should be on:

DCE, RTS, CTS, DTR, DSR and CD

In both DTE and DCE modes, the TXD and RXD lights will blink during data transfer.

4.4 System Status Indicators

The following system status indicators are provided on the front panel.

- **SYS OK** — This LED blinks to indicate that the system is functioning properly. The LED acts as a “heartbeat” indicator and is never turned off unless there is an unrecoverable error.
- **ON** — When on, this LED indicates that the power supply is functioning properly.

4.5 Error Code Display

When a program-detectable error occurs, all channel status indicators are turned off and a two-level error code is displayed using the two-digit channel display. The two error codes are flashed alternately.

4.6 Rear Panel

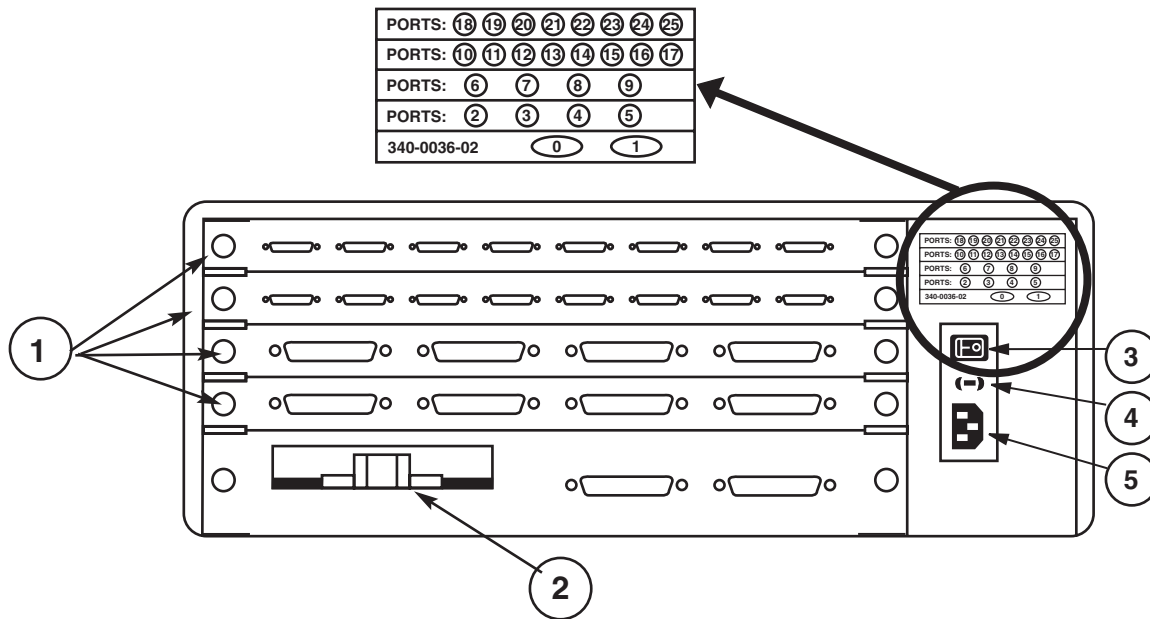

The rear panel of the LinkUp 5294 is equipped with the following:

1. Up to 34 serial (RS-232/V.24 compatible) Ports, numbered 0 through 33.
2. An A.19/.15, 50/60 Hz air flow fan.
3. A rocker-type on/off power switch.
4. A 1-amp, 250-volt fuse just below the power switch (which can be removed by sliding out the rubber fuse cartridge with a screwdriver).
5. A power cord receptacle (below the fuse).

5. Electrical Characteristics

This chapter covers the power specifications of the LinkUp 5294 and the requirements of the RS-232C interface for synchronous and asynchronous communications.

5.1 Power Specifications

The LinkUp 5294 power supply is rated at 50 watts and operates on 115 or 230 volts (plus or minus 15%) at 50 or 60 Hz (plus or minus 2 Hz). Its power connector is the international standard CEE-22.

NOTE

Units with 115 volts are shipped with a 7-foot NEMA 5-15P three-prong plug.

The LinkUp 5294 is certified to operate in accordance with the following standards:

- **UL** — Underwriters Laboratory: Listed with EDP Equipment/Office (Standards 478), File No. E87479.
- **CSA** — Canadian Standards Association: Certified.
- **IEC** — International Electrotechnical Commission: Designed to meet IEC 380.
- **BPO** — British Post Office: Meets the requirements of Technical Guide #26.
- **FCC** — Federal Communications Commission: Complies with the requirements of U.S. 47CFR Part 15 Subpart J, Class B, assuming shielded RS-232C cables are used.

5.2 Cable Pin Requirements

All of the ports on the LinkUp 5294 support the standard EIA RS-232C interface signals. In the next three sections, the signals specific to synchronous and asynchronous communications are identified.

Synchronous Port

A minimum conductor synchronous cable that will work with Bell compatible sync modems and the LinkUp 5294 in Modem Eliminator mode requires the following pins: 1 through 8, 15, 17, and 20. If the LinkUp 5294 is to be dialed from the host, Pin 22 must also be supported.

1	Frame Ground	1
2	Transmit Data (TxD)	2
3	Receive Data (RxD)	3
4	Request To Send (RTS)	4
5	Clear To Send (CTS)	5
6	Data Set Ready (DSR)	6
7	Signal Ground	7
8	Data Carrier Detected (DCD)	8
15	Transmit Clock (TxC)	15
17	Receive Clock (RxC)	17
20	Data Terminal Ready (DTR)	20
22	Ring Indicator (RI)	22

Asynchronous Port with DB25 Connector

The minimum requirements of an asynchronous RS-232C cable for use with dedicated terminals provide Pins 1 through 8 and 20. The minimum requirements for use with auto-answer modems provide Pins 1 through 8, 20, and 22.

For directly-connected printers, certain printer types may use Pin 11 to supply a Not Busy signal.

1	Frame Ground	1
2	Transmit Data (TxD)	2
3	Receive Data (RxD)	3
4	Request To Send (RTS)	4
5	Clear To Send (CTS)	5
6	Data Set Ready (DSR)	6
7	Signal Ground	7
8	Data Carrier Detected (DCD)	8
11	Busy	11
20	Data Terminal Ready (DTR)	20
22	Ring Indicator (RI)	22

Asynchronous Port with DB9 Connector

Cable pinouts for the RS-232C DB9 connector are shown below.

1	Data Carrier Detected (DCD)	1
2	Receive Data (RxD)	2
3	Transmit Data (TxD)	3
4	Data Terminal Ready (DTR)	4
5	Signal Ground	5
6	Data Set Ready (DSR)	6
7	Request To Send (RTS)	7
8	Clear To Send (CTS)	8
9	Ring Indicator (RI)	9

6. Installation

This chapter describes installation of the LinkUp 5294. A typical local installation to a single host is described. Attachment of local and remote (to the LinkUp 5294) terminals and printers is also included in **Sections 6.3, 6.4, and 6.5**. Special considerations for dual host and remote host environments are described in Section 6.6.

Information regarding the configuration of the communication and work station parameters for the System/36 and the System/38 is given in **Appendices E and F**, respectively, of this manual.

6.1 Installing the LinkUp 5294 and the Configuration Terminal

Configuration and installation of the LinkUp 5294 requires attachment of an asynchronous terminal to one of the asynchronous ports. The terminal is then used in conjunction with the Configurator menus to set the logical configuration parameters. The terminal used for this purpose is referred to as the Configuration Terminal throughout this section.

We recommend that a local terminal be used for initial installation and configuration. This will simplify problem isolation during the installation process. Therefore, the following sections assume that the configuration terminal will be locally attached to the LinkUp 5294. If a remote terminal must be used, see **Section 6.4**.

6.1.1 UNPACK THE LINKUP 5294

The LinkUp 5294 is carefully packed in a 25.5" x 15.8" x 11" box. A label on the outside of the box lists the model of the unit, serial number, firmware version number, date of manufacture, voltage setting of the power switch (115 or 230 VAC), and other electrical information. Inside you will find a release notice for the latest firmware version, a power cord, and the LinkUp 5294.

Carefully remove the contents of the box and check to see that the above items are present. If an item is missing or defective call your supplier.

NOTE

The power cord shipped with units set for 230-volt operation does not include an AC plug. You must supply the appropriate plug.

6.1.2 INSTALL THE LINKUP 5294

The only additional equipment needed to install the LinkUp 5294 is an asynchronous terminal, or personal computer with terminal emulation software installed, and an appropriate length of RS-232C cable. You may also want a small for tightening the cable connection.

The LinkUp 5294 is shipped with all asynchronous RS-232C ports configured as follows:

- DCE
- Autobaud
- 8 bits/character
- No parity
- 1 stop bit

The location of the LinkUp 5294 is not critical as long as the maximum recommended cable lengths are not exceeded. Temperature and humidity are considerations; however, the LinkUp 5294 is no more sensitive than other computer or data-processing equipment. During initial installation and testing, it may be helpful to position the LinkUp 5294 so that the front-panel indicators are easily visible.

6.1.3 SET UP THE CONFIGURATION TERMINAL

Refer to **Appendix G** for information on setting up your terminal for use with the LinkUp 5294. Ensure that the configuration terminal is set for initial operation with the following values:

- No parity
- 8 data bits
- 1 stop bit

Seven data bits and even parity is also allowed during initial configuration. This configuration allows use of virtually any asynchronous display terminal for configuration. These values are the initial default values for parameters that may be changed later to suit specific requirements.

6.1.4 CONNECT THE CONFIGURATION TERMINAL

Connect the terminal to an asynchronous port of the LinkUp 5294 using a standard RS-232C cable. See **Section 5.2** for required cable pinouts. No other data cable connections are required now.

6.1.5 ESTABLISH COMMUNICATION

Power on both the LinkUp 5294 and the terminal. Allow a short time, approximately 2 or 3 seconds, for the LinkUp 5294 to perform its internal power-on self tests. Once the selftests are completed and all systems are functioning normally, the SYS OK LED on the front panel begins blinking slowly and 02 appears in the CHANNEL/ERROR display. If this does not occur, see **Chapter 9**.

A banner message similar to the following is displayed on the screen:

```
***5294 CONTROLLER EMULATOR - V1.00U3***  
  
(For Help, Type '?' after any Prompt. To Abort Connect Sequence, Type 'I')  
(To Delete Response Characters, use 'Rubout'. To Cancel Response, 'ctrl x'.)
```

The connection is complete when the following prompt appears on the terminal screen:

Enter Device Type (ADM3A):

6.1.6 SELECT A DEVICE TYPE

Determine the appropriate Terminal ID for your terminal and enter it in response to the Enter Device Type prompt.

Type a question mark <?> or refer to **Appendix G** for a list of valid terminal types. If you are using a terminal that is not listed directly, but which emulates one of the supported terminals, use the Terminal ID for the emulated terminal.

NOTE

A question mark <?> followed by <Enter> is a valid response at any time during Connect and Configuration Modes. It displays a brief description of the response expected by the LinkUp 5294.

6.2 Accessing the LinkUp 5294 Configurator

This section describes access to the Configurator Mode of the LinkUp 5294. Since logical configuration is unique for each installation, all system information pertinent to this control unit and its attached devices must be readily available and understood before proceeding.

To enter System Management Mode, follow these steps:

1. Establish the connection and enter the appropriate Device Type as described in **Section 6.1**. The prompt “Enter LU Number (0):” is displayed.
2. Enter Port Test Mode by typing 1 in response to the above prompt. The Port Test Mode Menu appears.
3. Select Option 1 from the Port Test Mode Menu to enter System Management Mode. The first entry into System Management Mode requires no password, but the prompt, “Specify New System Password:”, appears. Enter a new password to protect against unauthorized access to System Management Mode.

NOTE

If the LinkUp 5294 has been previously configured, you may be prompted to enter a password before entry into System Management Mode is allowed. Get the correct password from the System Manager. (If the password is not known, see Section 7.7 of this manual.)

After entry of a password (if required) and/or a new password (or Enter), the System Management Mode menu is displayed.

4. Select Option 1, Configurator Mode, from the System Management Mode menu. The prompt “Enter Item to be Configured:” appears, indicating that you are in Configurator Mode. Refer to **Chapter 7** for complete details on use of the Configurator.

Configure the synchronous port, asynchronous port, and LU parameters as required for your installation. Save the changes by entering END at the Enter Change(s): prompt. Exit Configurator and System Management Modes using the same command.

6.3 Connecting Additional Local Terminals

Having specified port characteristics to the LinkUp 5294 with the Configurator, ensure that additional terminals you connect are configured correctly. For further information refer to **Appendix G**, which gives individual setup details for all supported terminal types, or consult the literature provided by the terminal manufacturer.

Connect each terminal to the appropriate asynchronous port of the LinkUp 5294 using a standard RS-232C cable.

NOTE

When attaching devices to those ports having DB9 connectors, DB9-to-DB25 converter cables may be required. Standard IBM AT serial cables, available from your local PC dealer, may be used.

6.4 Connecting Remote Terminals

For remote terminals, full-duplex asynchronous modems are required. The modems attached to the LinkUp 5294 ports should be configured properly for switched or dedicated lines.

6.4.1 LINE CONFIGURATION

Modems on the LinkUp 5294 end of switched lines should permit the following:

- Auto-answer mode.
- Loss-of-Carrier disconnect (causes modem to drop DSR and return to auto-answer state if phone line becomes disconnected).
- External DTR control (causes modem to disconnect from phone line if the LinkUp 5294 drops DTR).

6.4.2 MODEM CONSIDERATIONS

Auto-answer modems must be optioned to pass Ring Indicator (Pin 22) to the LinkUp 5294 and for DTE control of DTR (Pin 20). In auto-answer mode, the LinkUp 5294 raises DTR in response to a positive going signal on Ring Indicator. The Ring Indicator signal must be set to be held low or negative except when ringing occurs. See the literature provided with the modem.

User-friendly messages which are generated by some modems (such as Connect) must be disabled. Such messages will interfere with the LinkUp 5294 autobaud detection, causing error during connection.

Connect the modem to the switched or dedicated communication line as appropriate. Connect the modem to an asynchronous port on the LinkUp 5294 using an RS-232C cable. (The LinkUp 5294 port must be configured for DTE operation.)

Connect the terminal to the other modem with an RS-232C cable. Then connect the modem to an appropriate communications line.

6.5 Connecting Printers

Printers may be connected to the LinkUp 5294 in one of two ways. Printers which use a serial interface (RS-232C cable) may be connected directly to the LinkUp 5294 using one of the asynchronous ports. The attachment may be either local, using only a cable, or remote, using a pair of modems. An alternative is to attach the printer through the auxiliary port of a terminal which is in turn attached to the LinkUp 5294. Special considerations for installation of printers are discussed in the following paragraphs.

6.5.1 LOCAL PRINTERS

The following information applies if a directly attached printer is used:

- The port to be used must be configured with no overridable parameters, since the printer cannot be used to answer Connect Mode prompts.
- Configure the LU associated with the port as a PRT (printer) LU.
- Connect the printer to one of the async ports on the rear of the LinkUp 5294. Make sure that the port interface parameters agree. The autobaud option cannot be used for printers.

Once the printer is turned on and put on line, it should be recognized by the LinkUp 5294. If the host is properly configured, there is no further action required.

6.5.2 REMOTE PRINTERS

In addition to the considerations listed above, the following applies to remote printers:

- Connect the printer to the modem as instructed by the modem manufacturer's literature. A telephone is required to dial the number unless the printer or modem provides an alternate dialing method.
- The LinkUp 5294 modem should be optioned for Auto Answer if the printer operator will be dialing into the port. Set the communications parameters of the printer, modems, and the LinkUp 5294 port to match. A fixed baud rate must be used.

At the LinkUp 5294 site, the operator can monitor the port and observe the Ring Indicator flashing during the dial-up. Once the LinkUp 5294 answers the call, the DTR and DSR lights will remain on. If this does not happen, refer to **Chapter 9** for help in correcting the problem.

6.5.3 AUXILIARY PRINTERS

The following considerations apply to auxiliary printers attached directly to remotely connected terminals.

- Verify that the auxiliary port of the chosen terminal is supported by the LinkUp 5294. Refer to the **Appendix G** for a list of terminals which support auxiliary printers.
- Connect the printer to the auxiliary or printer port of the terminal. Set the auxiliary port parameters to agree with the printer requirements.
- The LU associated with the terminal must be configured to support an auxiliary printer LU. The printer itself is defined through configuration of its own LU.

6.6 Connecting the LinkUp 5294 to the Host Computer

The LinkUp 5294 can be attached to the host front end in one of three ways as shown in Figure 6-1.

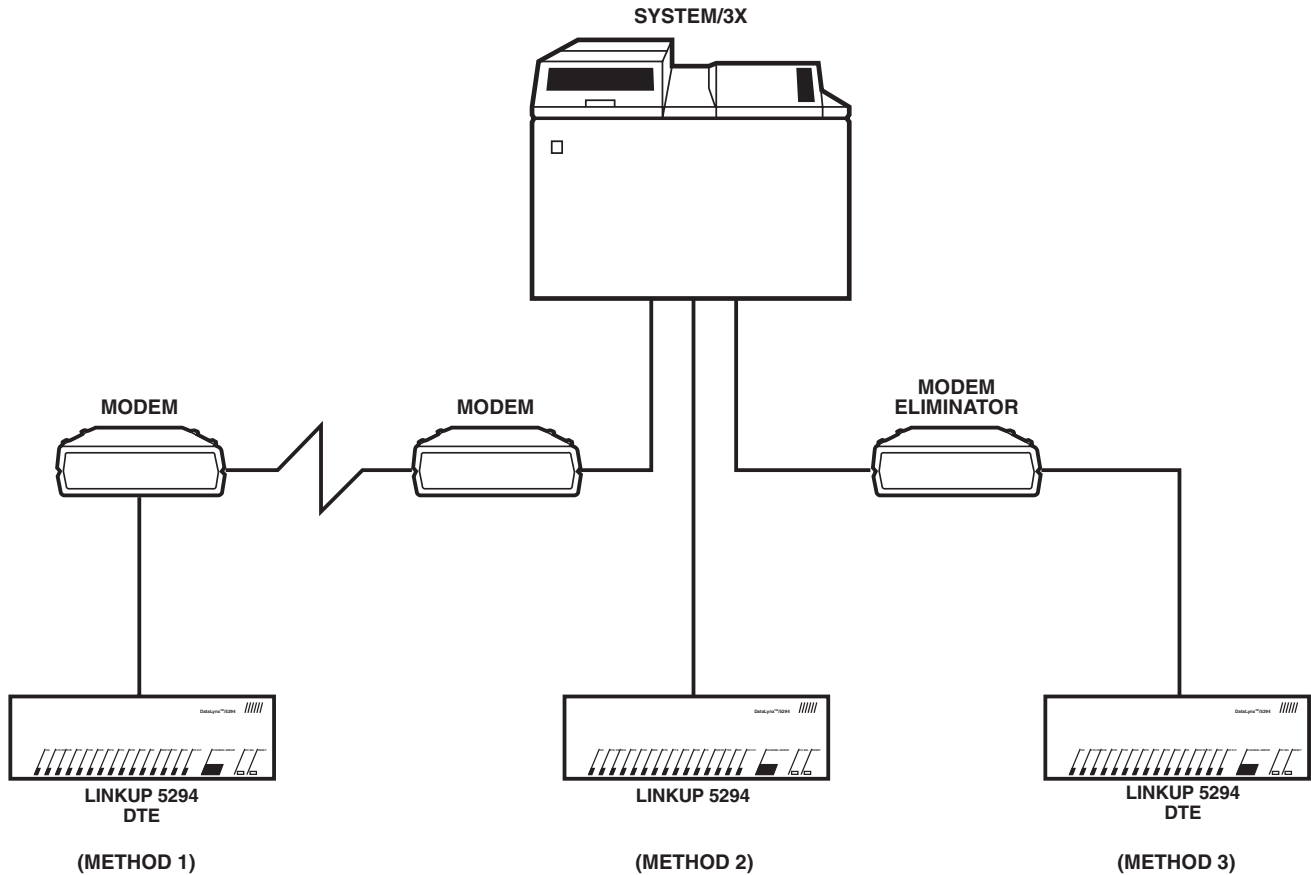

As shown in Figure 6-1, the DTE/DCE setting of the port depends on the type of connection used.

Method 1:

If the LinkUp 5294 is attached using a pair of synchronous modems, the sync port must be configured as DTE. The two modems are connected through a dial-up or dedicated line. In such an installation, clocking is typically provided by the modem; thus the LinkUp 5294 bit rate must be set for EXTERNAL clocking. Refer to the modem manufacturer's literature for instructions on setting the modem for Internal Clocking and Carrier Controlled by Request to Send.

Method 2:

This method is used when the LinkUp 5294 is installed in close proximity to the S/3X. The connection consists of a single cable with no other communications equipment. In this case, the LinkUp 5294 sync port must be configured as DCE. The bit rate is controlled by the LinkUp 5294 and is set during configuration of the sync port. The LinkUp 5294 uses an internal modem eliminator which provides the necessary clocking signals.

Method 3:

This method is similar to Method 1 except that a modem eliminator is used in place of the pair of modems and the intervening line. The LinkUp 5294 port is set as DTE and the bit rate is controlled externally.

A special case of such an installation is an X.25 network environment. The Modem Eliminator depicted in Figure 6-1 could be a very complex network which connects a variety of devices in addition to the LinkUp 5294 and the host.

6.6.1 REQUIREMENTS

Before connecting to the host, get the following information so that you can configure the synchronous ports correctly.

- Link Station address. (If both ports 0 and 1 are used, they may have the same Link Station number.)
- Bit Rate. Use external clocking if the LinkUp 5294 is set for DTE, or specify a bit rate if the LinkUp 5294 is DCE.
- Whether NRZI (Non-Return to Zero Inverted) encoding is used.
- Line configuration half or full duplex). If a half-duplex line is used, the LinkUp 5294 will wait for CTS from the modem before sending data.

6.6.2 DUAL HOST INSTALLATIONS

By using the LinkUp 5294's two synchronous ports, you can enable the LinkUp 5294 to emulate up to four controllers. These controllers can be defined to communicate with different host computers. For example, a System/34 host can be attached to one of the synchronous ports, while a System/38 host can be connected to the other port. Under this application, you can select which host you want to access by specifying the appropriately associated logical unit during Connect Mode.

Figure 6-2 shows a dual host application with the LinkUp 5294 remotely connected to two different host computers. In this example, the 32 logical units have been divided between the two synchronous ports as follows:

- LU 0 and 2 through 16 - Port 0
- LU 17 through 32 - Port 1

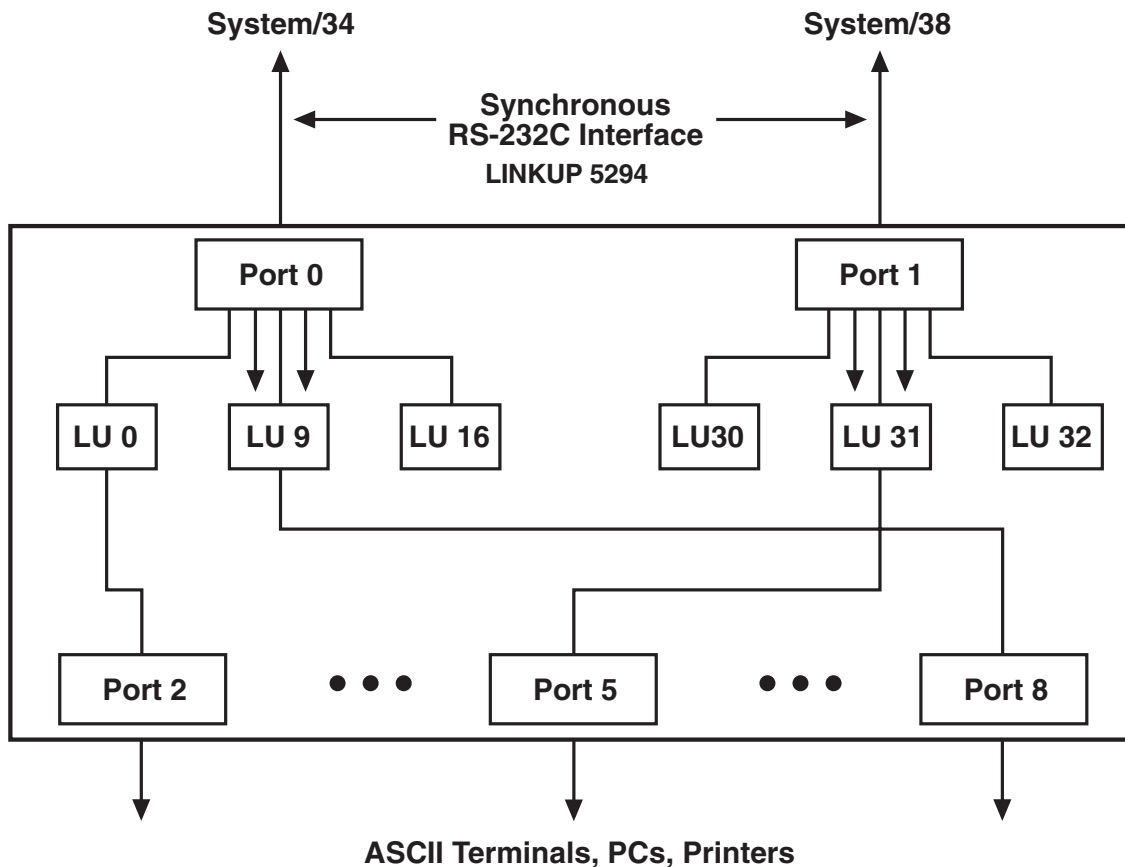

6.6.3 ESTABLISH COMMUNICATION WITH THE HOST

If the LinkUp 5294 is configured as DTE:

The DTE and DTR indicators should come on when all of the equipment is connected and powered on. After the modem is powered on, the TXC and RXC lights will indicate the clocking signals. After the host connection is completed, CTS, RTS, CD, TXD, and RXD should also be present.

If the LinkUp 5294 is configured as DCE:

When all of the equipment is connected and powered on, the DCE, CTS (if full-duplex), DSR, TXC, and RXC lights should come on. After the host connection is completed, RTS, CD, TXD, and RXD should also be present.

If the correct front panel signals are not present, refer to **Chapter 9**. If neither the TXD nor RXD light is flashing, there is no synchronous line between the LinkUp 5294 and the host computer. Contact the host operator and make sure that the line has been activated.

7. Operation

The LinkUp 5294 operates in six different modes:

1. **Connect Mode** — typically the operating session encountered prior to accessing the others; allows you to sign on to the LinkUp 5294.
2. **Port Test Mode** — allows you to perform several diagnostic and information functions: Interface Signal Display, Character Display Test, and Character Echo Test.
3. **System Management Mode** — allows you to perform the following diagnostic and information functions:
 - Interface Signal Display (similar to the function in Port Test Mode)
 - Sync Port Address Trace
 - Async Port Trace
 - Product Configuration and Levels Display
 - Sync Port Trace
 - Character Display Test (also provided in Port Test Mode)
 - Character Echo Test (also provided in Port Test Mode)
 - LU and Async Port Summary
 - Remote Reset
 - SNA/SDLC Counters
4. **Configurator Mode** — enables you to define the operating and environmental characteristics in which the LinkUp 5294 will function.
5. **Emulation Mode** — the standard operating session encountered by a terminal operator communicating with the System/3X host.
6. **Setup Mode** — lets you restore the factory default configuration parameter values defined in the LinkUp 5294.

7.1 Operating Requirements

To establish an operating session with the LinkUp 5294 the following hardware and software requirements must be met:

7.1.1 CABLES AND CONNECTIONS

As discussed in **Chapter 5**, all LinkUp 5294 connectors (ports) support a standard RS-232C interface. Each device or 3X host Integrated Communications Adapter (ICA) must be connected to the LinkUp 5294 by a shielded RS-232C cable.

When a terminal, printer, personal computer, or 3X host is attached directly to a LinkUp 5294 port, it is called a Local connection; when they are attached by modems, it is called a Remote connection. (Remote connections can be through switched or dedicated lines.)

7.1.2 SYSTEM/3X HOST

On the synchronous side, the LinkUp 5294 must be attached either directly (by its integrated modem eliminator) or remotely (by synchronous modems) to your System/3X host's ICA. As previously discussed, the adapter can be any of the following:

- A single-line communications adapter
- A multi-line (equal to four lines) communications adapter
- An eight-line communications adapter

CAUTION:

Your 3X host's communication line must be configured comparably to the parameters of the LinkUp 5294.

7.1.3 ASCII TERMINAL

Virtually any ASCII terminal can be used to operate the LinkUp 5294; however, it must be compatible with one of the Terminal Modules supported by the LinkUp 5294. See **Appendix D** for a list of those terminals currently supported.

Your selected terminal must also be set up according to the following general terminal configuration or switch settings:

- Character Mode = ON (as opposed to Block or Line Mode)
- Full Duplex = ON
- Auto New Line = OFF (if switch-selected)
- Auto Line Feed = OFF
- Cursor addressing = ON
- Auto Scroll = OFF (if switch-selected)
- DTR and DCD = ON, DSR = OFF (if switch-selected)
- Baud Rate = LinkUp 5294 configured settings
- Word Length (composed of Data Bits, Parity, and Stop Bits) = LinkUp 5294 configured settings (most commonly implemented as 8 data bits, no parity, and 1 stop bit)
- Keyboard must be decoupled from the display (if switch selected). See note below.

NOTE

The LinkUp 5294 must handle any and all screen changes to the terminal. This means the terminal must be set so that whenever a key is pressed on the keyboard, its character is transmitted directly to the LinkUp 5294 rather than to the terminal's display. This setup is commonly called Conversational Mode. If your terminal's keyboard cannot be decoupled from its display (Conversational Mode = ON), you should avoid using those keys which locally affect the display. If they are not avoided, the result will be a garbled display, requiring you to invoke the LinkUp 5294 Refresh Screen extended keyboard function.

7.1.4 PERSONAL COMPUTERS AND TERMINAL EMULATION SOFTWARE

In order for the LinkUp 5294 to operate with a personal computer or word processor, a terminal-emulation software package must be installed on the PC or word processor and must be compatible with one of the Terminal Module IDs provided by the LinkUp 5294. See **Appendix D** of this manual for a list of those personal computers and word processors currently supported, as well as suggested terminal-emulation software packages.

7.1.5 ASCII PRINTER

When using an ASCII printer, be sure to confirm that its switch-selected parameters match those configured in the LinkUp 5294. For example, the RS-232C line signals for physical flow control (equivalent to the printer's Not Busy signal) and device ready (the printer's Off-line signal) or the printer's logical flow control code.

7.1.6 MODEMS

When you are remotely located from the LinkUp 5294, you must communicate with the LinkUp 5294 over switched or dedicated lines in full-duplex mode with asynchronous modems. When a switched line is used, be sure to confirm that the modems are optioned as follows:

- The modem automatically answers an incoming call
- The DCD line state must not be held artificially high
- The modem should hang up when DTR drops
- The modem (attached to the LinkUp 5294) must not echo commands or characters.

When the LinkUp 5294 is remotely located from your System/3X host, it must communicate with your host over switched or dedicated lines in half- or full-duplex mode with synchronous modems. To assure that this remote connection is operating optimally, be sure to confirm that your modems are optioned as follows:

- The modem provides clocking (internal)
- The modem allows the LinkUp 5294 to control CD by RTS

7.1.7 PACKET NETWORK TERMINAL NODE

The LinkUp 5294 can be configured to operate in an asynchronous data packet network in one of two generic ways:

- The LinkUp 5294 recognizes that the terminal PAD echoes all hex values, which means the PAD performs all cursor-positioning functions.
- The LinkUp 5294 recognizes that the terminal PAD echoes only certain hex values.

In the second situation, the PAD (or terminal node) might be set up to echo only displayable characters: those including hexadecimal values 20 to 7E. When a PAD is set up in this way, the LinkUp 5294 is not able to suppress your input to a non-display field, such as during a password entry. This means that your input will display even though it should not.

Another PAD option might include setting it to echo some of the ASCII control codes within the range of 00 through 1F hex as well. This setting combined with one or both of the following PAD options would give the LinkUp 5294 limited control over the terminal's cursor positioning.

LINKUP 5294 WITH DL5294 FIRMWARE

- Setting the node to forward packets of data to the LinkUp 5294 after receipt of a control code hex value of 00 through 1F and 7F from the terminal.
- Setting the node to forward packets of data to the LinkUp 5294 after a specified time (in milliseconds) of terminal inactivity has transpired.

For example, in this PAD-configured environment, the LinkUp 5294 could support the System/3X field auto-exit capability. When a PAD echoes characters, the LinkUp 5294 is unable to move the cursor according to this standard 3X facility unless it is notified in some way to do so. Setting the PAD with either of these options will succeed in notifying the LinkUp 5294.

7.2 Connect Mode

As shipped from the factory, Connect Mode is the first operating session you will establish with the LinkUp 5294. Once established, you can select which mode you want to access next.

NOTE

Depending on your operating criteria, you may restrict your terminal operators from ever encountering this mode. If restriction is desired, then you must define the LinkUp 5294 configuration parameter values (found in Configurator Mode) as non-overridable.

7.2.1 SIGN-ON MENU

The Connect Mode sign-on menu consists of a display of the firmware version number (represented as V1.xxxx, where *x* is any integer from 0 to 9) installed in the LinkUp 5294, followed by the first of as many as 15 menu prompts. A sample screen is shown below.

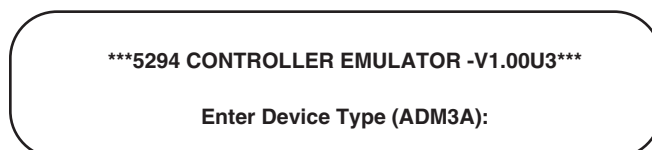

As the LinkUp 5294 is shipped from the factory, this menu will appear immediately after you press your selected ASCII terminal's <Enter> key twice. This procedure lets the LinkUp 5294 automatically detect the incoming baud rate of your terminal and match it.

7.2.2 MENU PROMPTS AND PARAMETERS

As previously mentioned, when the Connect Mode Sign-On screen displays, a sequence of menu prompts follows. In general, the format of these prompts is: ENTER “parameter name” (default value):.

Each prompt allows you to confirm the default value for a specific LinkUp 5294 configuration parameter, or enter a new value. The number of menu prompts which ultimately display depends on which of the following parameters (if any) are defined as overridable during Configurator Mode:

- Device type
- Logical Unit Number
- Password protection (at two levels)
- Inactivity Time Limit
- Reconnect Time Limit
- Local Copy Printer LU Number
- Auxiliary Printer LU Number
- Setup parameters for Auxiliary Printer (page length, line density, etc.)

As the LinkUp is shipped from the factory, your initial Connect Mode Sign-On screen will display only two menu prompts:

Enter Device Type (ADM3A):

Enter LU Number (0):

A sample Connect Mode session where all of the possible configuration parameters have been defined as overridable is shown in Figure 7-1. Items underlined are those keyed in by a terminal operator.

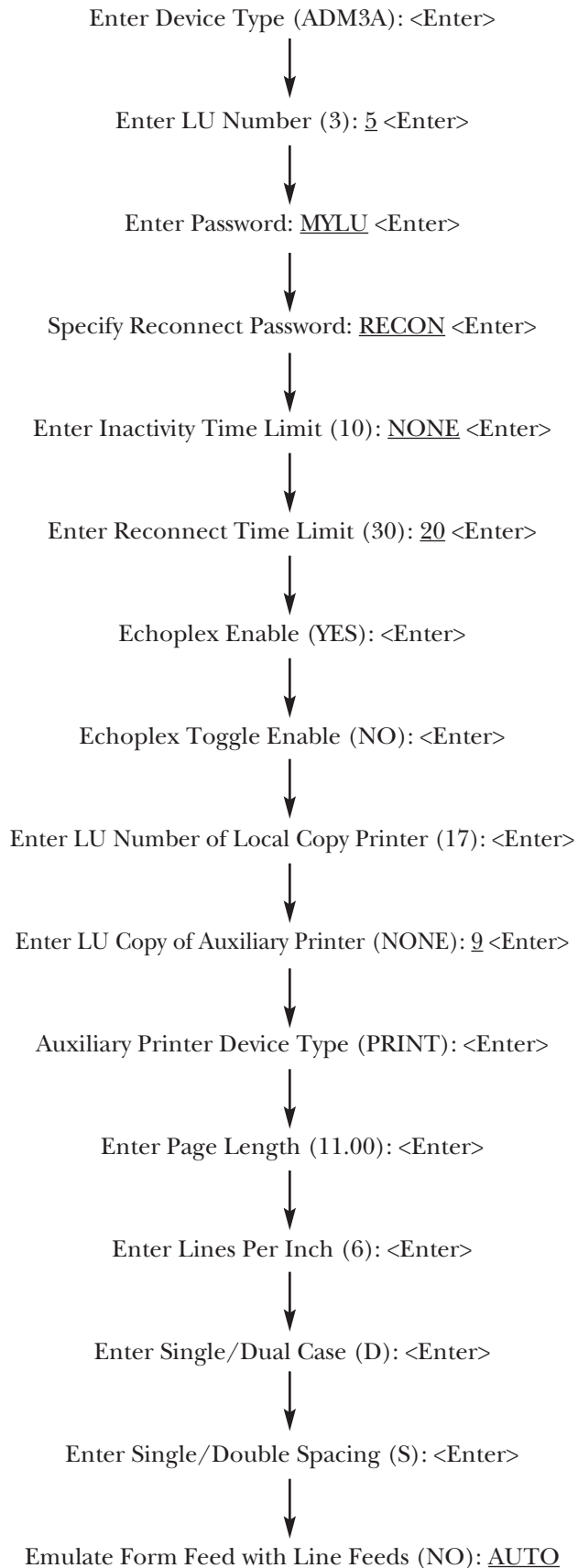

Refer to **Section 7.5.7** for the definition and values appropriate to the following menu prompt parameters:

- Device Type
- LU Number

NOTE

Entering 1 at the LU Number prompt during Connect Mode will advance you to Port Test Mode if the internal RUN/SETUP switch is on RUN. It will advance you to Setup Mode if the internal switch is on SETUP. (See Section 7.7).

Refer to **Section 7.5.8** for the definitions and values corresponding to the following parameters:

1. Password
2. Reconnect Password
3. Inactivity Time Limit
4. Reconnect Time Limit
5. Echoplex Enable
6. Echoplex Toggle Enabled
7. LU Number of Local Copy Printer
8. LU Number of Auxiliary Printer

Refer to **Section 7.5.9** for the definitions and values corresponding to the following parameters:

1. Auxiliary Printer Device Type
2. Page Length
3. Lines Per Inch
4. Single/Dual Case
5. Single/Double Spacing
6. Emulate Form Feed with Line Feeds

NOTE

Although the parameters 2 through 5 above are displayed and allow you to enter valid values, they are not used or supported by the LinkUp 5294 at this time.

A secondary Connect Mode sign-on screen is shown below.

```

****5294 CONTROLLER EMULATOR - V1.00U3****
Enter Device Type (ADM3A):
Enter LU Number (3): 5
Enter Reconnect Password:
```

This screen displays only if a Reconnect Time Limit is defined and the connection established with the LinkUp 5294 is either physically or logically disconnected. An example of a physical disconnection would be if a remotely established communication line hung up. An example of a logical disconnection would be if an Inactivity Time Limit was defined in the LinkUp 5294 by Configurator Mode and the LinkUp 5294 timed out after the specified time limit was reached.

NOTE

The menu prompt requesting a Reconnect Password only displays if a password was specified in the LinkUp 5294 through the Configurator Mode.

Refer to Section 7.5 of this manual for further information about the LinkUp 5294 facilities supporting this secondary sign-on screen.

7.2.3 EDITING INSTRUCTIONS

The following key sequences are valid to edit the Connect Mode menu prompts:

- **RETURN or ENTER (<Enter>)** — Enters the typed response. If no response is typed at the prompt prior to pressing <Enter>, the default value is assumed for the prompt and the next prompt in the connect sequence is displayed.
- **<BACKSPACE> or <DELETE>** — Deletes the last character typed.
- **<CTRL/X>** — (Press these keys simultaneously.) Deletes all characters typed at the current prompt.

NOTE

Remote connections require you to answer each prompt within five minutes. If this time limit is exceeded, the LinkUp 5294 will abort your Connect Mode attempt and drop the line.

The following three entries are valid responses for each of the Connect Mode menu prompts:

- **<!>** — Restarts Connect Mode beginning with the first prompt.
- **parameter value** — Any one of those defined as appropriate for each prompt. (If an invalid parameter is entered, or a valid one incorrectly typed, then an error message will display.)
- **<?>** — Displays a help message which includes the range of valid values for the current parameter. If you get lost or confused, <?> will usually give enough help to allow you to find your bearings. Certain help messages cause the screen to be cleared before display. The screen will also be cleared when full.

7.2.4 ERROR MESSAGES

If invalid entries are made during Connect Mode, one of the following self-explanatory messages will display on your screen.

Value Errors:

SYNTAX ERROR.
 UNRECOGNIZED RESPONSE.
 ILLEGAL CHARACTER.
 MAXIMUM STRING LENGTH EXCEEDED.
 MAXIMUM LINE LENGTH EXCEEDED.
 VALUE OUT OF RANGE.
 INVALID.
 TRAILING CHARACTERS IGNORED.
 NOT SUPPORTED IN THIS RELEASE.

Compatibility Errors:

LU# NOT AVAILABLE.
 LU# NOT COMPATIBLE WITH DEVICE TYPE.
 LU# NOT PRINTER TYPE.
 LU# NOT AUX PRINTER TYPE.
 DISPLAY DOES NOT SUPPORT AUXILIARY PRINTER
 CAUTION (PAGE LENGTH X LINES PER INCH) HAS NON-INTEGER
 RESULT; LINE COUNT PER PAGE NOT UPDATED.

Operational Error:

INACTIVITY TIME LIMIT EXCEEDED.
 CONNECT REQUEST FAILED.
 UNABLE TO READ EEPROM. DEFAULT CHARACTERISTICS ASSUMED.

7.3 Port Test Mode

Port Test Mode uses various port tests and traces which use the following conventions:

- Data from the LinkUp 5294 to the terminal or host is enclosed in square brackets ([]).
- Data from the terminal or host to the LinkUp 5294 is displayed without brackets.
- Complete messages, which could consist of only a single character, are separated by a space.
- Data is displayed on the first 23 lines of the screen, with line 24 reserved for messages. If the terminal supports dual intensity, the first set of 23 data lines are displayed in low intensity. When 23 lines have been displayed, the second set of 23 lines overwrites the first data in high intensity. By alternating between high and low intensity, the most recent data is easily located. If the terminal used does not support dual intensity, all wrapped data is displayed in the same intensity.
- The <SPACE> bar is a toggle which freezes and restarts the display. When the display is frozen, data is buffered by the LinkUp 5294. If this buffer overflows, a string of asterisks (***) will appear in the trace data.
- The <Enter> key ends the trace and returns to the Options menu.
- To clear stored trace data, type an asterisk (*).

To access Port Test Mode, establish the connection to the LinkUp 5294 either by direct connection or by a dial-up line. Answer the **Enter Device Type** prompt with the appropriate response for your terminal type.

When the LinkUp 5294 prompts for entry of an LU (Logical Unit) number, type 1 followed by <Enter>. The Port Test Mode menu will appear on the terminal screen.

```
***PORT TEST MODE***

Options:

1. System Management Mode
2. Interface Signal Display
3. Character Display Test
4. Character Echo Test

Enter Choice:
```

7.3.1 PORT TEST MODE MENU AND FUNCTIONS

At the Port Test Mode menu, type the number which corresponds to the function to be performed. Other accepted responses are <?>, END, and QUIT. All responses must be followed by <Enter>.

Port Test functions can only be performed on your own port. This allows any number of operators to access Port Test Mode at the same time. Each option is described below.

NOTE

If a port is configured for Option 3, Port Test Mode is not available.

- **System Management Mode (Option 1)** — This provides access to System Management Mode functions which are described in **Section 7.4**.
- **Interface Signal Display (Option 2)** — The Interface Signal Display is a remote representation of the front panel RS-232C status indicators. When selected from the Port Test Mode menu, this feature is used to monitor your own asynchronous port. A typical display is shown at the top of the next column.

```
INTERFACE SIGNALS
PORT n

T R R C D D D R T R
X X T T T S C / X X
D D S S R R D S C C

0 0 1 1 1 1 1 0 0 0

CR - Options Menu;    SPACE — Freeze/Start Display
```

One (1) indicates that the signal is logically true or on. A zero (0) indicates that the signal is not present. This display allows eight refreshes per second on a 2400-baud terminal. Refer to **Section 4.2** for an explanation of the individual signals.

- **Character Display Test (Option 3)** — This function is used to test the terminal screen for proper display of the alphanumeric characters. The Character Display Test generates a continuous output of the Alphabet Test message to the terminal.

System Management Mode may be accessed by only one operator (port) at a time. If you select Option 1 of Port Test Mode when System Management Mode is already in use, the following message is displayed and you are returned to Connect Mode:

System Management Mode already in use.

Unlike Port Test Mode, System Management Mode can be password-protected. When System Management Mode is selected, the LinkUp 5294 will prompt for entry of the system password if one is required. A new password may then be specified after successful entry of the old one. After the correct password has been entered, the System Management Mode Option Menu is displayed.

7.4.1 SYSTEM MANAGEMENT MODE MENU AND FUNCTIONS

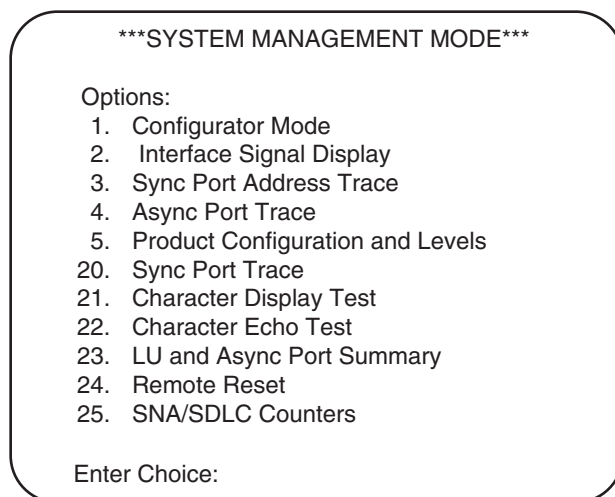

NOTE

The LinkUp 5294 is shipped from the factory with no password defined. Therefore, when you select System Management Mode for the first time, you are prompted to enter a new System password. You may specify a password at this time or you may default to no password by entering <Enter>. As long as the system remains without a password, you will be prompted only for a new one.

If you wish to clear a System password and return to the no-password condition, enter the current password at the **Enter System Password** prompt. Then enter NONE at the **Specify New System Password** prompt.

To avoid unauthorized access, use of a password is highly recommended.

If the System password is forgotten, the default condition of no password may be restored by executing a SETUP procedure. See **Section 7.7** for this procedure.

Options numbered 1 through 5 are available on both Standard and Deluxe models. Those options numbered 20 and above are only available with Deluxe firmware. Deluxe options will not appear on the menu if Standard firmware is installed.

All of the menu options are explained in the following paragraphs. To exit System Management Mode and return to Connect Mode, type either END or QUIT, followed by <Enter> in response to the Enter Choice prompt. Exit from each of the function screens is discussed below.

- **Configurator Mode (Option 1)** — When Item 1 is selected from the menu, the LinkUp 5294 enters Configurator Mode and the following prompt is displayed:

Enter Item to be Configured:

This allows configuration of Port and LU parameters. Configurator Mode is discussed in depth in **Section 7.5**. To exit Configurator Mode and return to System Management Mode, type END or QUIT <Enter>.

- **Interface Signal Display (Option 2)** — The Interface Signal Display is a remote representation of the front panel RS-232C signal indicators. This option is also available from Port Test Mode to monitor your own port only. (See **Section 7.3**.) When selected from System Management Mode, this test can be used to monitor any installed port on the LinkUp 5294.

When the option is selected, the LinkUp 5294 prompts you to enter the port to be monitored. After the port number is entered, the interface signal information is displayed. A typical display is shown below. Refer to **Section 4.2** for an explanation of the individual signals.

- **Sync Port Address Trace (Option 3)** — This option displays each control unit address as it appears in the synchronous data stream. Each address is displayed as a two-character hex value followed by two blanks. This can be used on a multipoint line to display all active Control Unit addresses.

```

INTERFACE SIGNALS
PORT n

T R R C D D D R T R
X X T T T S C / X X
D D S S R R D S C C

0 0 1 1 1 1 1 0 0 0

CR - Options Menu;    SPACE — Freeze/Start Display
    
```

When the option is selected, the LinkUp 5294 prompts you to enter the port to be monitored. After the port number is entered, the sync port address trace is displayed.

- **Async Port Trace (Option 4)** — This function monitors both the input and the output data stream for the selected async port. When the option is selected, the LinkUp 5294 prompts you to enter the port to be monitored. After the port number is entered, the async port trace is displayed.

```

**** 03 03 03 03 03 03 03 03 03 03
03 03 03 03 03 03 03 03 03 03
03 03 03 03 03 03 03 03 03 03

CR - Options Menu;    SPACE Freeze/Start Display
    
```

LINKUP 5294 WITH DL5294 FIRMWARE

- **Product Configuration and Levels (Option 5)** — This option displays the total number of ports, amount of RAM and EEPROM, firmware version number and calculated CRC. The Product Configuration and Levels screen is shown below.

```
***0D[110D0A2020202A2A2A03331373420434F4E54524F4C20554E495420454D554C41544F
52202D205632E303700055003300000000000000202A2A2A0D0A0D0A0A28466F722048656C70
2C205479706520273F272061667465722061E792050726F6D742E20546F2041626F72742043
6F6E6E6563742053657175656E63652C2054797065202721272E20290D0A28546F204456C6574
6520526573706F6E736520436861726163746572732C2075736520275275626F7574272E20546F
6576696365205479706520280041444D334100293A20] 77[57] 79[59] 35[35] 30[30] 70
[50] 0D [0D0A456E746572204C55204E756D62657220283900293A29]
```

CR- Options Menu; SPACE - Freeze/Start Display; * - Reset Trace

Possible values for the above hardware components are as follows:

- Available EEPROM: 16K bytes
- Available RAM: 256K to 768K bytes

Product Configuration

Available EEPROM	16K bytes
Available RAM	768K bytes
Available PORTS	34 Total
Firmware Version	1.00U3
Calculated CRC	F667H
CR - Options Menu	

- Available Ports: from 6 to 34 (includes sync ports) by multiples of four

The firmware version and calculated CRC will vary. Please record the values shown; your supplier will need to know them if you have to report a problem.

- **Sync Port Trace (Option 20)** — This function monitors both the input and output data stream of the selected sync port (and Sync Link Number, if so configured). Data is displayed as hex data, using the display formats and conventions described earlier, as well as the following:

A dash is introduced after the first row and after the first four hex values of a message, to mark the end of the link and transmission headers.

The two byte CRC is included in inbound messages to the LinkUp 5294.

The screen below illustrates a sync port trace, with explanation of trace format.

LINKUP 5294 WITH DL5294 FIRMWARE

- **Remote Reset (Option 24)** — This function is equivalent to a hardware reset (power off/power on). This causes sync port changes and printer port changes to take effect. When the reset screen is displayed, you must enter YES before the reset takes place. An answer of N, NO, or <Enter> will abort the command and the reset will not occur. Any other response will elicit an error message, and the Remote Reset caution message will be redisplayed. If a Remote Reset is aborted, you will be returned to the System Management Mode menu. If the reset is executed, you must begin again at the Connect Mode screen. The Remote Reset warning screen is shown below.

LU Number	0	2	3	4	5	6	7	8	9	10	11	12	13	14	15	16
LU type	Dsp	Dsp	Dsp	Dsp	Dsp	Dsp	Dsp	Dsp	Dsp	Dsp	Dsp	Dsp	Dsp	Dsp	Dsp	Dsp
LU State	Dis	Dis	Dis	Dis	Dis	Dis	Dis	Dis	Dis	Dis	Dis	Dis	Dis	Dis	Dis	Dis
Input Inhib	No	No	No	No	No	No	No	No	No	No	No	No	No	No	No	No
Echo	Yes	Yes	Yes	Yes	Yes	Yes	Yes	Yes	Yes	Yes	Yes	Yes	Yes	Yes	Yes	Yes
Insert Mode	No	No	No	No	No	No	No	No	No	No	No	No	No	No	No	No
Printer Pacing	N/A	N/A	N/A	N/A	N/A	N/A	N/A	N/A	N/A	N/A	N/A	N/A	N/A	N/A	N/A	N/A
LSID No.	0	2	3	N/A	N/A	N/A	N/A	N/A	N/A	N/A	N/A	N/A	N/A	N/A	N/A	N/A
Sync Port	0	0	0	0	0	0	0	0	0	0	0	0	0	0	0	0
Sync Link No.	0	0	0	0	0	0	0	0	0	0	0	0	0	0	0	0
Async Port	N/A	N/A	N/A	N/A	N/A	N/A	N/A	N/A	N/A	N/A	N/A	N/A	N/A	N/A	N/A	N/A

Port Number	2	3	4	5	6	7	8	9
Device Type	ADM3A	ADM3A	ADM3A	ADM3A	ADM3A	ADM3A	ADM3A	ADM3A
DTE/DCE	DCE	DCE	DCE	DCE	DCE	DCE	DCE	DCE
Bit Rate	Auto	Auto	Auto	Auto	Auto	Auto	Auto	Auto
No. of Bits	8	8	8	8	8	8	8	8
Parity	None	None	None	None	None	None	None	None
Stop Bits	1	1	1	1	1	1	1	1
Connect Mode	DED	DED	DED	DED	DED	DED	DED	DED
FC From Conv.	XON	XON	XON	XON	XON	XON	XON	XON
FC From Device	XON	XON	XON	XON	XON	XON	XON	XON
Dev Rdy Signal	DTR	DTR	DTR	DTR	DTR	DTR	DTR	DTR

- **SNA/SDLC Counters (Option 25)** — This function displays statistical information for the selected synchronous port. Entering the port number in response to the LinkUp 5294 prompt causes the screen shown below to be displayed.

****CAUTION****

The Remote Reset Breaks All LU Activity in a Non-Recoverable Way.

Are you CERTAIN that you want to Reset the Controller (YES OR NO)?

CR - Options Menu

These counters have the following meanings:

- **CRC Errors** — Cyclic Redundancy Check errors. This is the total number of blocks with errors that have been received from the host.

	SEND	RECEIVE
CRC Errors	N/A	1
Retransmissions	0	N/A
SNRMs	N/A	1
Frame Counters		
I Frames	666	1667
U Frames	2	2
Total	668	1669

- **Retransmissions** — This is the total number of blocks resent to the host.
- **SNRMs** — Set Normal Response Mode commands. This is the number of SNRMs received by the LinkUp 5294.
- **I-Frames** — Information Frames. This is the number of data frames sent and received.
- **U-Frames** — Unnumbered Frames. This is the number of unnumbered frames, such as SNRM, XID and DISC commands, sent and received.
- **Total** — The total number of I-Frames and U-Frames.

Values for the first 5 items are displayed as decimal numbers between 0 and 65535. The last item (Total) is counted to 131070. If these maximum displayable values are reached, the counters are not automatically reset.

All counts are reset to zero when the LinkUp is turned off, or when Remote Reset is issued. These counts are not affected by a host-generate REQMS with Reset request.

The following keys are active during this operation.

<R> resets the counters. (This does not reset RECFMS totals.)

<D> is used to refresh the display.

<Enter> is used to return to System Management Mode menu.

- **Set Date/Time (Option 26)** — Current date: yy/mm/dd; Current time: hh:mm:ss; Clock correct? (y/n):

7.5 Configurator Mode

Configurator Mode may only be accessed from one terminal at a time. To access it, you must first be in System Management Mode. Select Option 1 from the System Management Mode options menu. The LinkUp 5294 will enter Configurator Mode and the following prompt will be displayed:

Enter Item to be Configured:

As previously mentioned, Configurator Mode enables you to define the operating and environmental characteristics in which the LinkUp 5294 will function. The following menus are employed to accomplish this task:

1. Synchronous port(s)
2. Asynchronous port(s)
3. Logical Unit (displays)
4. Logical Unit (printers)
5. Logical Unit (auxiliary printers)

7.5.1 HELP MESSAGES DURING CONFIGURATION

Help messages are available at any time during configuration. These messages are displayed on the terminal screen and provide information on valid responses and available options. If you need a brief reminder of acceptable responses during the configuration process, simply type <?> <Enter> and an appropriate help message will be displayed on the screen.

The Help Screen for the **Enter Item to be Configured:** prompt is shown below:

Enter one of the following items:

PORT	-To configure First/Next Physical Port.
PORT n	-To configure Physical Port n, where n is in the range 0 to 33.
LU	-To configure the First/Next Logical Unit.
LU n	-To configure Logical Unit n, where n is 0 or 2 to 32.
<RETURN>	-To configure the next item in the standard system sequence, which is Sync Port(s), Async Ports, Logical Units.
STATUS	-To display LU numbers and Ports.
END	-To terminate Configurator Mode.

NOTE: Port and Logical Unit ranges depend on system setup.

TO CONTINUE PRESS <RETURN> KEY:

7.5.2 CONSISTENCY CHECKING

The Configurator validates individual parameter values as they are entered. This includes checking for parameter interdependencies. In some cases the Configurator will change multiple parameter values as the result of a single change by the operator. For example, when an async port Communications Interface is changed from DTE to DCE, the Flow Control from Device and Device Ready pin numbers are forced to Pins 5 and 6 (CTS and DSR), respectively.

If a new parameter value is entered which is not compatible with another existing parameter, the message Incompatible with Parameter (n) is displayed, where (n) is the number of the existing parameter. You are then prompted again to enter parameter changes.

If your response is invalid or mistyped, an error message is displayed.

7.5.3 OVERRIDABLE PARAMETERS

Certain parameter values in the asynchronous port and LU menus are followed by a plus (+) or minus (-) sign. The plus sign allows the parameter to be changed at connect time, while the minus sign does not allow change. If no sign is present, the parameter is not overridable at connect time. These flags may be entered independently of the actual parameter value. Thus, the following three examples are all valid change entries for the Device Type parameter (Asynchronous Port Menu):

1 = ADM3A 1 = - 1 = ADM3A +

At connect time, the value for a non-overridable parameter is the default value specified by the Configurator. However, for an overridable parameter the Connect processor will display a prompt followed by the default, to allow entry of a different value if necessary.

For example, if an installation only uses Televideo 925 terminals, all directly coupled to the LinkUp 5294, then the default Device Type (TV925) should be set by the Configurator as non-overridable. An operator performing a normal connect to the LinkUp 5294 would not then be asked to enter the Device Type.

Parameters for Printer and Auxiliary Printer LUs cannot be set as overridable. Since these LUs are controlled by the host, their parameters cannot be changed at connect time.

If a port and its associated default LU are configured with no overridable parameters, a connecting terminal will immediately enter Emulation Mode with no prompts being displayed. If configuration is necessary, execute the INITIALIZE TERMINAL sequence (usually [ESC <]) to exit Emulation Mode and enter Connect Mode. Configurator Mode may then be accessed from System Management Mode.

7.5.4 CONFIGURATOR MODE COMMANDS

Configuration commands are entered from the terminal keyboard. The LinkUp 5294 always provides a prompt whenever a response is required. The general format of a configuration menu is:

[n] [Parameter Name] [current setting] [overridable]

[n][Parameter Name] [current setting]

Enter Change(s):

The response format is: [n] = [New Value]

where: [n] is the number shown on the menu, and [New Value] is a valid setting

As an example, a typical configuration menu is shown below:

Current Parameter Values for Port 0 (SYNC):	
1. Communications Interface	DTE
2. Bit Rate	EXT
3. Connect Mode	DED
4. Half/Full Duplex Line	FULL
5. NRZI Encoding	NO
6. Emulation Mode	5294
7. Number of Link Stations	02
8. Link 0 Station Address	CF
9. Link 1 Station Address	CE
10. Link 2 Station Address	00
11. Link 3 Station Address	00
Enter Change(s):	

More than one parameter may be changed on a single line; however, parameters must be entered in ascending sequence. For example:

Enter Change(s): 2=EXT, 5=YES, 7=04 <Enter>

Spaces between configuration entries and characters are optional and are ignored. For multiple changes on a single line, use a comma to separate entries.

Unless otherwise stated, all commands are followed by the <Enter> key.

During configuration, help messages are available at two levels. To illustrate this, assume you typed PORT 2 <Enter> in response to the Enter Item(s) to be Configured: prompt. The following screen appears:

At this point, typing <?> <Enter> will display a list of acceptable responses, valid formats, editing keys, etc. The general format for a response is also shown.

Current Parameter Values for Port 2:	
1. Device Type	ADM3A +
2. Associated Logical Unit	0 +
3. Communications Interface	DCE
4. Bit Rate	AUTO
5. Number of Bits/Char (Excluding Parity)	8
6. Parity	NONE
7. Number of Stop Bits	1
8. Connect Mode	DED
9. Flow Control from Converter	XON
10. Flow Control from Device	XON
11. Device Ready Signal	DTR
12. Packet Network Access	N
13. Auto Exit Enabled	YES
Enter Change(s):	

A second level of help exists for each specific parameter. For instance, to see the available responses for parameter #1, type: 1 = ? <Enter>. This will show all of the available settings for parameter 1 on the current menu.

The <CR> (Redisplay) Command

After a valid change line has been entered, the menu is not automatically redisplayed. Press <Enter> at the next Enter Change(s): prompt to redisplay the menu with the new values included.

<BACKSPACE> or <RUBOUT>

Backspace or Delete keys can be used during configuration to correct typing mistakes. The command deletes the last character of the current entry.

The <CTRL/X> (Delete Entry) Command

This command deletes the current entry. This may be more convenient than the single character Backspace or Delete key for correcting typing errors. This command does not require <Enter>.

The <!> (Restore Previous Values) Command

During a configuration session, it is sometimes desirable to reset all of the changes to the previously held values. This can be done by typing an exclamation point <!> followed by <Enter> in response to the Enter Change(s) prompt. This command only resets the parameters changed since the last END command. In other words, the parameters changed on other menus or previous edits to the current menu are not reset.

NOTE

If it becomes desirable to reset all configuration parameters to their factory default values, the SETUP procedure may be used. Refer to Section 7.7 for this procedure.

The END Command

To exit from a configuration menu, type END followed by <Enter> in response to the Enter Change(s): prompt. This stores the new parameter settings and in most cases returns you to the Enter Item(s) to Be Configured: prompt. There is one Exception. When you type END to exit the Asynchronous Port configuration menu after configuring the port to which your terminal is connected, the LinkUp 5294 takes you out of Configurator Mode and displays the following message on your screen:

****Connect/Port Test Cancelled - Port Reconfigured.****

When you see this message, press Enter to return to Connect Mode. If you are connected to the LinkUp 5294 by modems, you will have to redial.

The END command is also used in response to the Enter Item(s) to Be Configured prompt to exit from Configurator Mode and return to the System Management Mode menu. Note that changes made while in Configurator Mode are saved when END is typed in response to the Enter Change(s): prompt.

On exit from a specific menu level in Configurator Mode, all modified parameters will be saved in EEPROM. If not currently in use, the item will be immediately reinitialized with its new parameters. Otherwise, reinitialization will occur when the item becomes idle—for example, when you disconnect from the LU.

NOTE

A hardware reset must be performed after you have reconfigured a synchronous port or assigned an LU to a new or modified synchronous port, SDLC Link Number or Local Station Address. A hardware reset is performed by powering the LinkUp off and back on, or by activating the Remote Reset command from System Management Mode.

LINKUP 5294 WITH DL5294 FIRMWARE

The <CR> Next Item Command

Configurable items may be automatically configured in the following sequence:

Synchronous Ports (0, 1)

Asynchronous Ports (2 through 33, depending on the number and type of async boards installed)

Logical Units (0, 2 through 32)

When the Enter Item(s) To Be Configured: prompt is displayed, the <Enter> key alone will increment to the next item in the above sequence. This is particularly useful the first time the LinkUp 5294 must be configured, as it eliminates the need to type in each item separately.

The STATUS Command

Enter this in answer to the Enter Item To Be Configured prompt to display a table of all the LinkUp 5294 ports and LUs and their respective operating states and device types. (Refer to **Section 8.2** for further information about this table.)

The Status Screen is shown on the top of the next page.

The PORT n Command

Enter this at the **Enter Item To Be Configured:** prompt, where n is the number of a LinkUp 5294 physical port (either synchronous [0 or 1] or asynchronous [2 through 33]). If PORT is entered by itself, the LinkUp 5294 displays the next incremented PORT number, based on the one you last configured.

Logical Unit Status	(P= Pending Disconnect; D = Disconnected;) (I = In-Use; R = Reconnectable; U = Undefined)															
LU No.	0	2	3	4	5	6	7	8	9	10	11	12	13	14	15	16
LU Type	7	7	7	7	7	7	7	7	7	7	7	7	7	7	7	7
Status	D	D	D	D	D	D	D	D	D	D	D	D	D	D	D	D
Sync Port	0	0	0	0	0	0	0	0	0	0	0	0	0	0	0	0
Sync Link #	0	0	0	0	0	0	0	0	0	0	0	0	0	0	0	0
LSID #																
Async Port																

LU No.	17	18	19	20	21	22	23	24	25	26	27	28	29	30	31	32
LU Type	7	7	7	7	7	7	7	7	7	7	7	7	7	7	7	7
Status	D	D	D	D	D	D	D	D	D	D	D	D	D	D	D	D
Sync Port	0	0	0	0	0	0	0	0	0	0	0	0	0	0	0	0
Sync Link #	0	0	0	0	0	0	0	0	0	0	0	0	0	0	0	0
LSID #																
Async Port																

TO CONTINUE PRESS <RETURN> KEY: _

The LU n Command

Enter this at the **Enter Item To Be Configured:** prompt, where n is the number of a LinkUp 5294 Logical Unit (numbered 0 or 2 through 32). If LU is entered by itself, the LinkUp 5294 displays the next incremented LU menu, based on the one you last configured.

The DSPLY, PRT, AUX Commands

Enter one of these at the Enter Logical Unit Type: prompt to define the LU as a display, printer (connected to its own port), or an auxiliary printer.

7.5.5 CONFIGURATION PROCEDURES

To configure the LinkUp 5294 for use in an IBM or other synchronous host environment, it is recommended that the following steps be completed in the order listed:

1. Configure the synchronous port(s).
2. Configure all asynchronous ports that will be used except for the port to which your terminal is connected.
3. Configure all Logical Units that will be used.
4. Perform the Reset Sync Port command in order to effect sync port configuration changes.
5. Configure the async port to which your terminal is connected (if necessary).

7.5.6 SYNCHRONOUS PORT PARAMETERS

1. Communications Interface

Valid values are: DTE (Data Terminal Equipment) or DCE (Data Communications Equipment).

When connecting the LinkUp 5294 to the communications adapter on your System/3X by modems or line drivers (modem eliminators) on a point-to-point or multi-point communication line, this parameter must be set to DTE. However, when connecting the LinkUp 5294 directly to your host's adapter, the Communications Interface must be specified as DCE. This latter application is possible because of the LinkUp 5294's integrated modem eliminator.

2. Bit Rate

Valid values are: 1200, 2000, 2400, 3600, 4800, 7200, 9600, 14400, 19200, or EXT.

When the LinkUp 5294 is directly connected to your host's adapter (Communications Interface = DCE), the LinkUp 5294 must provide the clocking signals. Selecting a specific bit rate will enable the LinkUp 5294 to do this.

For connections through modems or line drivers (Communications Interface = DTE), the modem or line driver will provide the clocking signals. Set the bit rate to EXT (External) in this application.

3. Connect Mode

Valid values are: DED (Dedicated) or AUTO (Automatic Answer).

When the LinkUp 5294 is connected to your host through modems, specifying AUTO will enable the LinkUp 5294 to automatically answer an incoming call from your host. When this is not the application, DED should be specified.

4. Half/Full Duplex Line

Valid values are FULL or HALF.

The value defined for this parameter depends on whether the LinkUp 5294 port is configured for a DTE or DCE interface, and is as follows:

- **HALF-DUPLEX (DTE)** — Following data reception from the host, the LinkUp 5294 waits for the Carrier Detect signal to go low before raising the Request-To-Send signal.

LINKUP 5294 WITH DL5294 FIRMWARE

- **HALF-DUPLEX (DCE)** — Following data reception from the host, the LinkUp 5294 waits for the Request-To-Send signal to go low before raising the Carrier.
- **FULL-DUPLEX (DTE)** — Following data reception from the host, the LinkUp 5294 immediately raises the Request-To-Send signal.
- **FULL-DUPLEX (DCE)** — Following data reception from the host, the LinkUp 5294 immediately raises the Carrier Detect signal and starts transmission.

NOTE

The LinkUp 5294 raises and lowers RTS under a DTE interface and CD under a DCE interface during Full Duplex operations because it is an essential procedure in multi-point applications; for example, a Control Unit on a multi-point line, which does not lower its RTS signal at the end of a transmission, prevents the other Control Unit(s) from ever using the line. The host's communication adapter should be set so its RTS signal is permanently raised.

5. NRZI Encoding

Valid values are YES or NO.

The appropriate value here depends on your host's requirements. Normally, a System/3X is strapped for NRZI encoding (specify YES); if not, the LinkUp 5294 is able to support direct encoding (specify NO).

6. Emulation Mode

Valid values are: 5251 (IBM 5251 Model 12 Remote Workstation Controller), 5294 (IBM 5294 Remote Cluster Controller), or 5394 (IBM 5394 Remote Cluster Controller).

NOTE

The 5294 and 5394 emulation modes do not support all of the actual IBM 5294 or 5394 Controller functions. For example, Text Write Assist is not supported. Consult your supplier for further information on these limitations.

7. Number of Link Stations

Valid values are: 0 through 4. This parameter dictates how many Link Station Addresses will be recognized by the LinkUp 5294 on this port; that is, how many controllers will be emulated by the LinkUp 5294 through this port. The addresses of these controllers are then specified in parameters 8 through 11, below. Values greater than one are valid on deluxe units only.

NOTE

A maximum of four Link Station Addresses may be specified on the two synchronous ports, in any combination. If a value for this parameter is specified so that this maximum is exceeded, the following error message is displayed:

7: VALUE OUT OF RANGE; TOTAL NUMBER OF LINK STATIONS FOR PORT 0 AND PORT I IS 4.

When the value of this parameter is lessened, Link Addresses (in parameters 8 through 11) which fall outside the valid range are automatically set to 0; for example, if parameter 7 is set to 0, parameters 8 through 11 will also be set to 0, and no controllers can be emulated on that port.

8-11. Link 0, Link 1, Link 2, and Link 3 Station Addresses

Valid values are: 0 through FE Hex. If 0 is entered, the LinkUp 5294 assumes that the Link Station Address is not to be used; if a Hex value beginning with an alpha character (A through F) is entered, that Hex value must be entered with a leading 0 in this example: 0A9.

Link Station Address is the term used to identify one of the LinkUp 5294 emulated controllers. To establish a communication link with your 3X host, you must define a viable Controller Address from the host for each controller.

NOTE

On deluxe models only, more than one Link Station Address can be supported for each synchronous port. This enables the LinkUp 5294 to emulate as many as four IBM Remote Controllers on a single port from a single line ICA.

CAUTION

If your unit is a deluxe model, note that each synchronous port configured to support two Link Station Addresses must have two distinct Controller Addresses, and must use the same emulation mode (5251, 5294, or 5394).

NOTE

If more Station Addresses are specified in Parameters 8 through 11 than were specified in Parameter 7, the following error message is displayed:

n: INCOMPATIBLE WITH PARAMETER 7.

7.5.7 ASYNCHRONOUS PORT PARAMETERS

The Asynchronous Port Menu is shown below:

1. Device Type

Valid values are:

Current Parameter Values For Port 4 (ASYNC):

1. Device Type	ADM3A+
2. Associated Logical Unit	4+
3. Communications Interface	DCE
4. Bit Rate	AUTO
5. Number of Bits/Char (Excluding Parity)	8
6. Parity	NONE
7. Number of Stop Bits	1
8. Connect Mode	DED
9. Flow Control from Converter	XON
10. Flow Control from Device	XON
11. Device Ready Signal	DTR
12. Packet Network Access	N
13. Auto Exit Enabled	YES

Enter Change(s):

For a terminal or PC:

ACT5AADM11	ADM21	
ADM3A	ADM3P	ANSI
COMPU	C7101	C7103
CY5291	DISPH	D200
HP45	HZ51	SCANS
TV910	TV910P	TV925
TV970	T5250	VIEWP
VP60	VT52	VT52X
VT100	VT220	WY30
WY60	WY60XWY100	
XT100		

For a printer:

CENTRN	C1300	DP8050	EPSON	GE3000	GEN34GEN44HPDPL
HPDPP	HPGEN	OKIM84	PRINT		

A Terminal or Printer Module ID is the appropriate response at this parameter. The correct module to enter depends on the device (terminal, PC, or printer) attached to the port being configured. Each module is based on a brand name ASCII terminal or printer.

NOTE

This parameter can be defined as overridable (+) or non-overridable (-).

When a Printer Module ID is entered, the LinkUp 5294 forces this parameter and the next one (Associated Logical Unit) to be non-overridable.

2. Associated Logical Unit

Valid values are: 0 and 2 through 32.

A Logical Unit is a virtual device address that is not tied to any one physical port. The LinkUp 5294 uses an LU as an identification number to keep track of your attached device; it is not the workstation address (Local Station ID) defined on your System/3X.

NOTE

This parameter can be defined as overridable (+) or non-overridable (-).

One (1) is only a valid entry during Connect Mode at the Enter LU Number menu prompt, and is used only to access Configurator Mode.

3. Communications Interface

Valid values are: DCE (Data Communications Equipment) or DTE (Data Terminal Equipment).

When connecting an asynchronous modem to a LinkUp 5294 asynchronous port, this value must be defined as DTE; but when connecting your terminal, PC, or printer directly to an asynchronous port, it must be set to DCE.

4. Bit Rate

Valid values are:

75	110	134	150	300	600	1200
2000	2400	4800	7200	9600	14400	19200

AUTO

AUTO enables the LinkUp 5294 to automatically detect the incoming baud rate of the device attached to its port. This is commonly called Autobaud detection. When AUTO is specified, the LinkUp 5294 is only able to determine the following bit rates:

19200 9600 4800 2400 1200 300 bps

NOTE

Any value received by a LinkUp 5294 port configured for AUTO, below 1200 bps, is treated as if it were 300 bps.

5. Number of Bits/Char (Excluding Parity)

Valid values are: 8 or 7.

Asynchronously transmitted data is structured as below, beginning with the start bit:

Start bit Character code bits Parity bit Stop bit(s)

NOTE

Set this value to match the character structure supported by your terminal, PC, or printer connected to the port you are configuring.

6. Parity

Valid values are: ODD, EVEN, MARK, SPACE, or NONE.

Parity enables the LinkUp 5294 to perform asynchronous error checking on the communication line between itself and your attached device. For a true parity check, ODD or EVEN are the recommended settings. If NONE is defined, no parity error checking will occur.

CAUTION

MARK and SPACE are valid only when 7 is defined for Number of Bits/Char; while ODD and EVEN can be defined with 7 or 8.

NOTE

Set this value to match the character structure supported by your terminal, PC, or printer connected to the port you are configuring.

7. Number of Stop Bits

Valid values are: 1, 1.5, or 2.

When defining this parameter take into account the bit rate of your attached device. Generally, for optimum bit rate performance, 1 stop bit is used; however, exceptions are: 2 stop bits at 110 bps and 1.5 stop bits at 134 bps.

NOTE

Set this value to match the character structure supported by your terminal, PC, or printer connected to the port you are configuring.

8. Connect Mode

Valid values are: DED (for Dedicated) or AUTO (for Automatic Answer).

When the LinkUp 5294 is connected to your terminal, PC, or printer by an asynchronous modem, specifying AUTO will enable the LinkUp 5294 to automatically answer an incoming call from your device. For directly connected devices, DED should be specified.

NOTE

When Communications Interface and Connect Mode are defined as DTE and AUTO, respectively, the LinkUp 5294 waits for Ring Indicator from the asynchronous modem before raising DTR. With DTR raised, the modem (configured to automatically answer an incoming call) accepts the dial-up connection and then raises DSR to the LinkUp 5294. However, when DCE and AUTO are respectively defined and DTR drops, the LinkUp 5294 terminates the coupled user session.

9. 10. Flow Control from Converter/Flow Control from Device

Valid values are: NONE, XON, CTS, RTS, DSR, DTR, or P11.

The values defined here let the LinkUp 5294 know what RS-232C line signals or XON/XOFF commands are being used to control the flow of data between itself and your attached device. See Table 7-1 before defining values for these parameters.

11. Device Ready Signal

Valid values are: NONE, CTS, RTS, DSR, or DTR.

The value defined here lets the LinkUp 5294 know which RS-232C signal to watch in order to determine when the device attached to its port is ready for operation. Consult Table 7-1 before defining a value for this parameter.

Table 7-1. Communications Interface, Flow Control, and Ready Signals

COMM. INTERFACE	FLOW CONTROL from CONVERTER	FLOW CONTROL from DEVICE	DEVICE READY
DCE	NONE/XON/CTS/DSR	NONE/XON	NONE/RTS/DTR
DCE	NONE/XON/CTS/DSR	DTR	NONE/RTS
DCE	NONE/XON/CTS/DSR	RTS/P11	NONE/DTR
DTE	NONE/XON/RTS/DTR	NONE/XON	NONE/CTS/DTR
DTE	NONE/XON/RTS/DTR	CTS	NONE/DSR
DTE	NONE/XON/RTS/DTR	DSR	NONE/CTS

12. Packet Network Access

Valid values are: N (for None), 1, or 2, or 3.

Values 1 and 2 are generic supports for asynchronous data packet networks. If you choose one (1), the LinkUp 5294 generates cursor positioning as it usually does. If you choose two (2), the LinkUp 5294 relies on the network’s terminal node to perform cursor positioning by means of its local echo of escape sequences, except in the following situations:

- When a screen wrap is required. This occurs when the cursor moves from the bottom to the top of the screen, or from the right margin to the left margin.
- When fast cursor left and fast cursor right are invoked.

13. Auto Exit Enabled

Valid values are: YES or NO.

When YES is defined here, the LinkUp 5294 moves the cursor to the next System/3X input field after it reaches the end of the field it is currently in, providing the field has been defined for auto-exit on your 3X host. To disable Auto Exit, specify NO for this parameter.

NOTE

When Parameter 12, Packet Network Access, is defined as N for none, then Parameter 13 cannot be defined as NO.

7.5.8 LOGICAL UNIT PARAMETERS FOR A DISPLAY

The Display Logical Unit Menu is shown below:

1. Associated Sync Port

Valid values are: 0 (for Port 0) or 1 (Port 1).

The value defined here lets the LinkUp 5294 know which physical synchronous port the LU under configuration is assigned to. The 32 LUs available on the LinkUp 5294 may be assigned in whatever way your application requires. For example, if you require only one synchronous port, then all the LUs can be defined to that single port; if you require two synchronous ports to emulate two remote controllers, you may divide the LUs between the two in any combination you wish.

Current Parameter Values For Logical Unit 2 (DSPLY):

1. Associated Sync Port	0
2. Associated SDLC Link Number	0
3. Local Station Address	NONE
4. Buffer Size	1920
5. Number of Screen Rows	24
6. Number of Screen Columns	80
7. Password	NONE
8. Inactivity Time Limit	NONE
9. Reconnect Time Limit	30
10. Logical Unit Number of Local Copy Printer	NONE
11. Logical Unit Number of Auxiliary Printer	NONE
12. Echoplex Enable	YES
13. Echoplex Toggle Enable	NO
14. Display Status Line Initially	NO
15. Character Set	US

Enter Change(s):

CAUTION

Whenever this parameter or either of the following two (Associated SDLC Link Number and Local Station Address) is reconfigured, a hardware reset must be performed on the LinkUp 5294.

NOTE

If, during a two synchronous port operation, the host sends a request to Port 1 for an LU associated with Port 0, the LinkUp 5294 responds with an Unavailable LU error message.

2. Associated SDLC Link Number

Valid value (for standard LinkUp 5294 units) is: 0 (for Link 0 Station Address).

Valid values (for deluxe units) are: 0 (for Link 0 Station Address), 1 (for Link 1 Station Address), 2 (for Link 2 Station Address), and 3 (for Link Station Address).

As previously mentioned, deluxe LinkUp 5294 units can logically emulate as many as four remote controllers per synchronous port. Therefore, not only must you define the LU (under configuration) to a specific synchronous port, you must also define it to a specific Link Station Address.

3. Local Station Address

Valid values are: Any hexadecimal value from 0 through 0F.

Local Station Address refers to the workstation identification number assigned to one of the devices (a display or printer) communicating with your System/3X host. It is also called a Local Session ID or LSID. The correct value for this parameter depends on what the designated LSID is on your System/3X host. Once this value is set, the LinkUp 5294 is able to establish a communications link between your 3X host and one or more of its LUs.

NOTE

Any LinkUp 5294 LU may be linked to any System/3X LSID at any Controller Address defined to one of the LinkUp 5294 Link Station Address; however, a one-to-one correspondence (one LSID to one LU) must be maintained.

An IBM 5251 Model 12 controller uses LSIDs numbered 0 and 2 through 9.

An IBM 5294 controller uses LSIDs numbered 0 through 9.

An IBM 5394 controller uses LSIDs numbered 0 through 0F.

4. Buffer Size

Valid value is: 1920.

There is only one value possible for this parameter. This is because 1920 is the standard buffer size of a 5250 Display.

5, 6. Number of Screen Rows/Number of Screen Columns

Valid value is: 24 (rows) by 80 (columns).

There is only one value possible for these parameters. This is because 24 by 80 is the standard size of a 5250 Display.

7. Password

Valid values are: Any combination of 1 to 6 alphanumeric characters, or NONE.

Specifying a password enables the LinkUp 5294 to protect the configured LU from being accessed (during Connect Mode) by everyone but the terminal operator assigned to that LU (the one who knows the password). When NONE is specified no password is defined, and the LinkUp 5294 cannot restrict anyone from accessing the configured LU.

Whenever a password is defined at this parameter, the LinkUp 5294 can also offer you a second level of password protection, called a Reconnect Password. A Reconnect Password allows the LinkUp 5294 to restrict access to your LU (so that only you can re-access it, since you alone know the specified password) in the event the LU session is interrupted due to a physical or logical disconnection; for example, if your communication line drops or the LinkUp 5294 times out after reaching the specified Inactivity Time Limit.

NOTE

Valid values for the Reconnect Password are: Any combination of 1 to 6 alphanumeric characters or NONE. If NONE is specified, or if you simply skip over to the appropriate Connect Mode prompt (by pressing <Enter>), the Reconnect Password defaults to the first level password configured to the LU.

Once a password is defined, you cannot sign on to the LinkUp 5294 (during Connect Mode, either initially or at a reconnect operation) until you successfully enter that password. The LinkUp 5294 allows you three attempts before advising you that your CONNECT REQUEST FAILED. When this message displays, the LinkUp 5294 also reinitializes the affected asynchronous port. If you are remotely connected, your line will be dropped.

8. Inactivity Time Limit

Valid values are: Any integer (representative of minutes) from 1 to 99, or NONE. When NONE is specified, it means no inactivity time-out will occur.

When an inactivity time limit is specified, it represents the maximum time that the LinkUp 5294 will maintain the coupling between an inactive terminal (one experiencing no keyboard input or host output) and an LU session. If an inactivity time limit is reached, the LinkUp 5294 responds by clearing your screen and displaying the following message before returning you to Connect Mode:

INACTIVITY TIME-OUT - DISCONNECTED

NOTE

This parameter can be defined as overridable (+) or non-overridable (-).

9. Reconnect Time Limit

Valid values are: Any integer (representative of minutes) from 0 to 99, or NONE. When 0 is specified, the LinkUp 5294 terminates a disconnected LU session immediately; if NONE is specified, the LinkUp 5294 holds a disconnected LU session open for reconnect indefinitely.

When a reconnect time limit is specified, it defines the maximum time in minutes that the LinkUp 5294 will hold a disconnected LU session open, enabling you to reconnect to the last screen display. Disconnections can be either physical, as when the remote telephone line drops, or logical, as when the LinkUp 5294 Inactivity Time Limit is reached.

NOTE

During reconnect state, the LinkUp 5294 responds to the System/3X host for your disconnected LU session as if nothing were wrong. In other words, if the host outputs data to the LU, the LinkUp 5294 stores it. Then, when you reconnect within the configured time limit, the LinkUp 5294 automatically updates your screen to reflect the new data.

This parameter can be defined as overridable (+) or non-overridable (-).

10. Logical Unit Number of Local Copy Printer

Valid values are: 0, 2 through 32, or NONE.

CAUTION

You may only specify an LU number configured as a printer. It must also be further defined as a Local Copy printer (LOC).

When an appropriate LU number is defined to this parameter, the assigned terminal operator will be able to invoke the extended keyboard functions of LOCAL COPY PRINT REQUEST and LOCAL COPY FORM FEED.

NOTE

This parameter can be defined as overridable (+) or non-overridable (-).

11. Logical Unit Number of Auxiliary Printer

Valid values are: 0, 2 through 32, or NONE.

CAUTION

You may only specify an LU number configured as an auxiliary printer (defined as AUX).

When an appropriate LU number is defined to this parameter, the assigned terminal user will be able to operate their terminal and auxiliary attached printer with the LinkUp 5294 Auxiliary Printer facility, allowing shared use of a single LinkUp 5294 asynchronous port.

NOTE

This parameter can be defined as overridable (+) or non-overridable (-).

12. Echoplex Enable

Valid values are: YES or NO.

If your application requires the LinkUp 5294 to echo characters and control codes back to your attached ASCII devices, specify YES at this parameter. If this is not the requirement, as when using the COMPU module, specify NO.

NOTE

This parameter can be defined as overridable (+) or non-overridable (-).

When the Packet Network Access parameter of the Asynchronous Port Configurator Menu is defined as 1 or 2, then the Echoplex Enable parameter is superseded.

13. Echoplex Toggle Enable

Valid values are: NO or YES.

Specifying YES at this parameter enables the LinkUp 5294 to respond to the extended keyboard function of TOGGLE ECHOPLEX ENABLED whenever you press it. This function allows you to selectively toggle when you want the LinkUp 5294 to echo characters and control codes back to their terminals.

NOTE

This parameter can be defined as overridable (+) or non-overridable (-).

When the Packet Network Access parameter of the Asynchronous Port Configurator Menu is defined as 1 or 2, then the Echoplex Toggle Enable parameter is superseded.

14. Display Status Line Initially

Valid values are: YES or NO.

This controls whether or not the Status Line is displayed after initial connection to the host. The default for this parameter is YES.

15. Character Set

Valid values are: US or MULTI.

US is the U.S. character translation currently available in versions of the LinkUp 5294 code before 1.15. MULTI is a multinational character translation based on IBM Multinational EBCDIC character set and an extended version of IBM Code Page 850 ASCII character set. The default value is US.

7.5.9 PRINTER LOGICAL UNIT PARAMETERS FOR A PRINTER OR AUXILIARY PRINTER

The Logical Unit Configuration menus for Printers and Auxiliary Printers are shown below. The default values are also shown. To access these menus, enter PRT or AUX at the **Enter Logical Unit Type (DSPLY)** prompt.

1. Associated Sync Port

Valid values are: 0 (for Port 0) or 1 (for Port 1)

The value defined here lets the LinkUp 5294 know which physical synchronous port the LU under configuration is assigned to. The 32 LUs available on the LinkUp 5294 may be assigned in whatever way your application requires. For example, if you require two synchronous ports to emulate two remote controllers, you may divide the LUs between the two in any combination you wish.

Current Parameter Values For Logical Unit 7 (PRT):

1. Associated Sync Port	0
2. Associated SDLC Link Number	0
3. Local Station Address	NONE
4. Operational Mode	LOC
5. Line Length (Columns)	132
6. Page Length (Inches)	11.00
7. Lines Per Inch	6
8. Single/Dual Case	D
9. Single/Double Spacing	S
10. Emulate FF with LF	NO
11. Character Set	US

Enter Change(s):

Current Parameter Values For Logical Unit 9 (AUX):

1. Associated Sync Port	0
2. Associated SDLC Link Number	0
3. Local Station Address	NONE
4. Operational Mode	LOC
5. Line Length (Columns)	132
6. Page Length (Inches)	11.00
7. Lines Per Inch	6
8. Single/Dual Case	D
9. Single/Double Spacing	S
10. Emulate FF with LF	NO
11. Character Set	US

Enter Change(s):

CAUTION

Whenever this parameter or either of the following two (Associated SDLC Link Number and Local Station Address) are reconfigured, a hardware reset must be performed on the LinkUp 5294.

NOTE

If, during a two synchronous port operation, the host sends a request to Port 1 for an LU associated with Port 0, the LinkUp 5294 responds with an unavailable LU error message.

2. Associated SDLC Link Number

Valid value for standard LinkUp 5294 units: 0 (for Link 0 Station Address).

Valid values for deluxe units: 0 (for Link 0 Station Address), 1 (for Link 1 Station Address), 2 (for Link 2 Station Address), and 3 (for Link 3 Station Address).

As previously mentioned, deluxe LinkUp 5294 can logically emulate as many as four remote controllers per synchronous port. Therefore, not only must you define the LU under configuration to a specific synchronous port, but you must also define it to a specific Link Station Address.

3. Local Station Address

Valid values are: Any hexadecimal value from 0 to 0F.

Local Station Address refers to the workstation identification number assigned to one of the devices (a display or printer) communicating with your System/3X host. It is also called a Local Session ID or LSID. The correct value for this parameter depends on what the designated LSID is on your System/3X host. Once this value is set, the LinkUp 5294 is able to establish a communication link between your 3X host and one or more of its LUs.

NOTE

Any LinkUp 5294 LU may be linked to any System/3X LSID viable to any Controller Address defined to one of the LinkUp 5294 Link Station Addresses; however, a one-to-one correspondence (one LSID to one LU) must be maintained.

An IBM 5251 Model 12 controller uses LSIDs numbered 0 and 2 through 9.

An IBM 5294 controller uses LSIDs numbered 0 through 9.

An IBM 5394 controller uses LSIDs numbered 0 through 0F.

Operational Mode

Valid values are: LOC (for Local Copy printer) or SYS (for System printer).

If you require the ability to print the contents of their terminal screens to a designated printer, you must select and define a printer LU for a local copy operational mode, or LOC. If your application necessitates being able to perform print jobs from your host, you must select and define a printer LU for a system operational mode, or SYS.

CAUTION

These two values are mutually exclusive. If one is defined to an LU, the other cannot be supported by the same LU.

Line Length (Columns)

Valid values are: Any integer from 40 to 132.

The value specified at this parameter represents the maximum line length permitted. The actual line length depends on the format controls sent by your host. Therefore, when defining your desired maximum, make sure it corresponds to the actual carriage width of the ASCII printer(s) you will be attaching to the LinkUp 5294.

NOTE

Although the values of parameters 6 through 9 can be changed on the configuration menus, they are ultimately controlled by the System/3X host; they are not used or supported by the LinkUp 5294 at this time.

6. Page Length (Inches)

Valid values are: Any number from 1 to 22, carried out to two decimal places. The entry format is nn.nn, representing decimal numbers from 01.00 to 22.00, inclusive.

7. Lines Per Inch

Valid values are: 6 or 8.

8. Single/Dual Case

Valid values are: D (for Dual case) or S (for Single case).

9. Single/Double Spacing

Valid values are: S (for Single spacing) or D (for Double spacing).

10. Emulate Form Feed with Line Feeds

Valid values are: NO, YES, or AUTO.

This parameter provides support for the SCS command Set Vertical Form.

If this parameter is set to NO, the LinkUp 5294 sends Form Feed when Form Feed is received from the host whether or not a standard or non-standard form length has been sent by the host through the SVF command, and whether or not an Escape sequence to specify form length exists for the printer. This is the default setting. It will be up to you to set proper forms length, etc., at the printer.

If the parameter is set to YES, the LinkUp 5294 sends the proper number of Line Feeds to the printer to emulate a Form Feed when Form Feed is received from the host, regardless of the forms length set by the SVF command or the capabilities of the printer.

If set to AUTO, the LinkUp 5294 sends an Escape sequence to the printer specifying the form length in lines per form (if there exists such a sequence) after receipt of a SVF command from the host. Form Feed will subsequently be sent to the terminal after receipt of Form Feed from the host. If no such Escape sequence exists (or if the length as specified by the SVF command is outside of the valid range of the Escape sequence), Form Feeds received from the host are emulated by the LinkUp 5294 with the proper number of Line Feeds.

11. Character Set

Valid values are: US and MULTI.

US is the U.S. character translation currently available in versions of the LinkUp 5294 code before 1.15. MULTI is a multinational character translation based on IBM Multinational EBCDIC character set and an extended version of IBM Code Page 850 ASCII character set. The default value is US.

Auxiliary Printer Device Type (AUX Menu Only)

Valid values are: CENTRN, CI300, DP8050, EPSON, GE3000, GEN34, GEN44, HPDPL, HPDPP, HPGEN, OKIM84, or PRINT.

A Printer Module ID is the appropriate response at this parameter. Each module is based on a brand name ASCII printer. To determine which module to select, the printer attached to your terminal users' auxiliary port must be:

- The actual printer type
- Its compatible
- Capable of emulating the actual printer type

7.5.10 SYNTAX ERROR MESSAGES

If invalid entries are made while editing in Configurator Mode, one of the following self-explanatory messages will be displayed on your screen:

SYNTAX ERROR.

UNRECOGNIZED RESPONSE.

ILLEGAL CHARACTER.

MAXIMUM STRING LENGTH EXCEEDED. MAXIMUM LINE LENGTH EXCEEDED. VALUE OUT OF RANGE.

INVALID.

TRAILING CHARACTERS IGNORED.

NOT SUPPORTED IN THIS RELEASE.

When the error corresponds to a specific parameter in one of the Configurator Mode menus, the respective message will be displayed in the following format:

n: {message}

where n is the number of the parameter in error and {message} is the appropriate error message. The brackets { } do not display; they are used here as markers only.

NOTE

Whenever you finish reconfiguring the parameters of the asynchronous port to which your terminal is connected, the LinkUp 5294 exits Configurator Mode, saves your changes, and displays the following message before returning you to Connect Mode:

****Connect Attempt Cancelled Port Reconfigured ****

7.5.11 PHYSICAL CONFIGURATION

Whenever you reconfigure a synchronous port you must perform a hardware reset in order to reinitialize it. This may be accomplished by powering the LinkUp 5294 off and back on again, or by using the Remote Reset function in the System Management Mode options menu.

A hardware reset must also be done when you reassign an LU to another synchronous port, SDLC Link

Number, and Local Station Address.

7.6 Emulation Mode

Emulation Mode is the operating session enabling you to communicate with your System/3X host as though the terminal, PC, printer, or auxiliary printer you are using is an actual IBM 5251 model 11 or 529x Display Workstation or 52xx Printer. A terminal or PC is defined as in session when the Sign-On menu of your System/3X host is displayed on its screen. (Emulation Mode will appear as it does in the screen below, if you advance to it prior to configuring the LinkUp 5294 as required by your application, or you have not yet connected it to your System/3X host.)



SYS AVAIL: * MSG WT: INS MODE: INPUT INH: AWFER

Typically, you enter Emulation Mode by correctly responding to the last Connect Mode menu prompt. However, if you define the LinkUp 5294 configurator parameters as non-overridable (-), the Connect Mode menu and prompts will not display and you will immediately enter Emulation Mode. Once in Emulation Mode, you can sign on to your 3X host and perform typical 3X session activities as any normal 5250 Workstation would.

NOTE

If you have restricted access to Connect Mode by making all Connect Mode prompts non-overridable, and if the LinkUp 5294 parameter of Bit Rate is defined as AUTO, you and your terminal operators must press <Enter> twice to enter Emulation Mode.

7.7 Setup Mode

Setup Mode resets all Configurator Mode parameters to their factory default values. Use Setup Mode when you are changing the number of asynchronous ports, or if you wish to convert a LinkUp 5294 to a Link Up 3174 (or vice versa). When upgrading the LinkUp firmware PROM cartridge, it is only necessary to go through Setup Mode when the release notice accompanying the upgrade specifies that it must be done.

NOTE

To make sure the Configurator Mode parameters you choose are consistent with the ones you chose in Setup Mode, it is recommended that you keep a record of all your Setup Mode configuration choices.

To enter Setup Mode, you must take the LinkUp apart and set an internal switch. Follow these

instructions carefully:

1. Turn off and unplug the LinkUp 5294.
2. Loosen the thumbscrews on either side of the main circuit board and slide the circuit board part way out. Move the two-position switch located near the PROM cartridge from the RUN position to the SETUP position. Carefully slide the main circuit board back into position, making sure that the CHANNEL SELECT and RESET buttons do not bind on the front panel.
3. Plug the LinkUp 5294 in and turn it on.
4. Connect a suitable display terminal (or PC with appropriate terminal emulation software installed) to Port 2 and power it on. The terminal must be set to operate with 8 bits and no parity. Its baud rate may be set for 300, 1200, 2400, 4800, 9600 or 19200.
5. Press <Enter> twice on your terminal to display the Connect Mode sign-on menu.
6. Proceed as though you wished to enter Configurator Mode: specify your terminal type, then answer <1> in response to the Enter LU number prompt.
7. Because of the setting of the internal RUN/SETUP switch, you will not enter Configurator Mode, but will instead enter Setup Mode. As shown in Figure 7-2, you must now enter the Setup Mode password; both DALYNX and SETUP are valid passwords, as shipped from the factory.
8. When the message appears telling you to reset the LinkUp 5294, all ports and LUs will have been set to their factory default parameters in EEPROM. Return the RUN/SETUP switch to the RUN position by taking the appropriate actions as described in Step 2.
9. Proceed to Configurator Mode to define the port and LU parameters as you desire.

```

Enter Device Type (HZ51): <Enter>

Enter LU Number (2): 1 <Enter>
      ↓
****SETUP MODE****
      ↓
ENTER SETUP PASSWORD DALYNX <Enter>

PARAMETER STORAGE IN PROGRESS.
      ↓
SWITCH TO CONFIGURATOR MODE
AND RESET LINKUP 5294.
      ↓

```

Figure 7-2. Sample Setup Mode Session.

8. Packet Network Access Applications

Packet Network Access support allows the LinkUp 5294 to be used in X.25 and other network environments facilitating transmission of asynchronous data. The LinkUp 5294 is located between the IBM host computer and the host PAD (Packet Assembler-Disassembler), as shown in Figure 8-1. The host PAD provides the interface between the LinkUp 5294 and the X.25 network. The terminal is connected to the Packet Data Network (PDN) through the terminal PAD. The terminal can be directly cabled to the PAD, or can dial into a public PAD port.

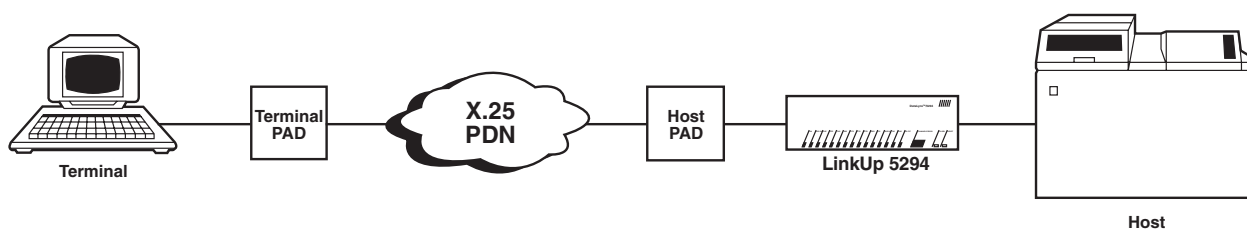

Figure 8-1. A Packet Data Network Environment.

The LinkUp 5294 will convert the host's synchronous data into an asynchronous data stream. The host PAD will bundle the asynchronous data into a packet and transmit it over the X.25 network to the terminal PAD. The terminal PAD will unbundle the asynchronous packet and send the data stream to the terminal. Conversely, the terminal's asynchronous data stream will be assembled into a packet and transmitted by the terminal PAD. The host PAD will receive the packet, unbundle it, and pass the asynchronous data stream to the LinkUp 5294. The LinkUp 5294 will now convert the asynchronous data into a synchronous data stream and send it to the host.

8.1 Terminology

The following abbreviations are used throughout this section

- **AID Keys** — Attention Identifiers. These are keys that require host processing. They are: <CLEAR>, <Enter>, Command keys, Roll keys, <HELP> and <PRINT>. When these keys are pressed, the LinkUp 5294 will normally lock the terminal's keyboard and send the information to the host. The host will generally return data for the display and signal the LinkUp 5294 to unlock the keyboard.
- **Auto Exit Field** — This is a type of field which is defined by the input field attributes of the IBM host application. After the operator has entered the last character of the field, the cursor will be positioned to the next input field automatically, without requiring the operator to press <TAB> or <FIELD EXIT>.
- **Character Echo** — This causes a character to appear on a terminal's display after a key on the keyboard has been pressed.
- **Cursor Movement Keys** — These are the Up Arrow, Down Arrow, Left Arrow, and Right Arrow keys.

They are generally handled by the LinkUp 5294, without requiring any information to go to the host.

- **Host PAD** — The PAD located at the host end of the network. In an X.25 network with minicomputers and asynchronous terminals, this is the PAD located at the minicomputer end of the network. In the LinkUp 5294 implementation where IBM hosts are used, this is the PAD located at the LinkUp 5294.
- **PAD** — Packet Assembler-Disassembler. This is a physical interface node with an asynchronous (RS-232C) port on one side and an X.25 protocol interface on the other side. A PAD is similar to an asynchronous modem in that both provide an interface to specialized communications lines.
- **PNA** — Packet Network Access. The LinkUp 5294 feature which allows connection of asynchronous terminals through an X.25 network.
- **PDN** — Packet Data Network. A network of private or public communications lines which use X.25 protocol.
- **Packet** — A collection of asynchronous data of varying length addressed for a specific destination.
- **Terminal PAD** — The PAD located at the asynchronous terminal end of the X.25 network.

8.2 Using the LinkUp 5294 with PDNs

In order to explain the way the LinkUp 5294 handles keystroke echo and cursor positioning with PDNs, it is necessary to explain how the LinkUp 5294 handles these with a directly connected terminal.

Figure 8-2 shows the flow of information between the keyboard, display, and the LinkUp 5294 when alphanumeric or cursor movement keys are pressed.

A = Press the Up Arrow key. Up Arrow keycode goes to the LinkUp 5294.

B = The LinkUp 5294 echoes the Up Arrow to the display (or in some cases sends a cursor address) and the cursor is repositioned.

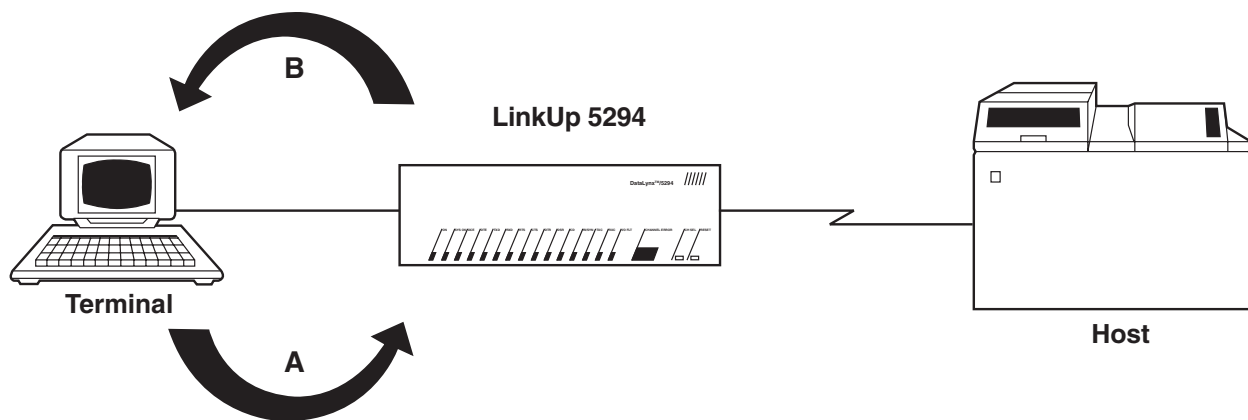

Figure 8-2. Cursor Movement Echo.

LINKUP 5294 WITH DL5294 FIRMWARE

PADs are capable of echoing keycodes back to the terminal. If the PAD echoes the keycode and the LinkUp 5294 also echoes the keycode, the result will be duplicate characters, as you can see in Figure 8-3. Therefore, it is important to configure the PAD and the LinkUp 5294 properly.

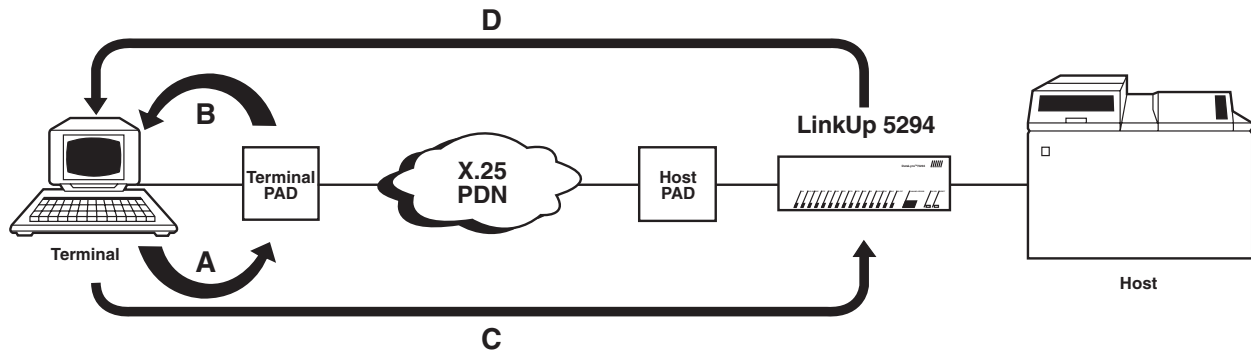

Figure 8-3. Double Echo with PAD.

Figure 8-4 shows the flow of information between the keyboard, display, and the LinkUp 5294 when AID keys are pressed.

A = Press the <CMD> key. The CMD 3 code goes to the LinkUp 5294.

B = Recognizing the AID key, the LinkUp 5294 locks the keyboard.

C = The CMD 3 code is sent to the host.

D = The host processes the command. Then appropriate data and an unlock keyboard command is sent to the LinkUp 5294.

E = The LinkUp 5294 sends the data and a cursor positioning command to the display, and then unlocks the keyboard.

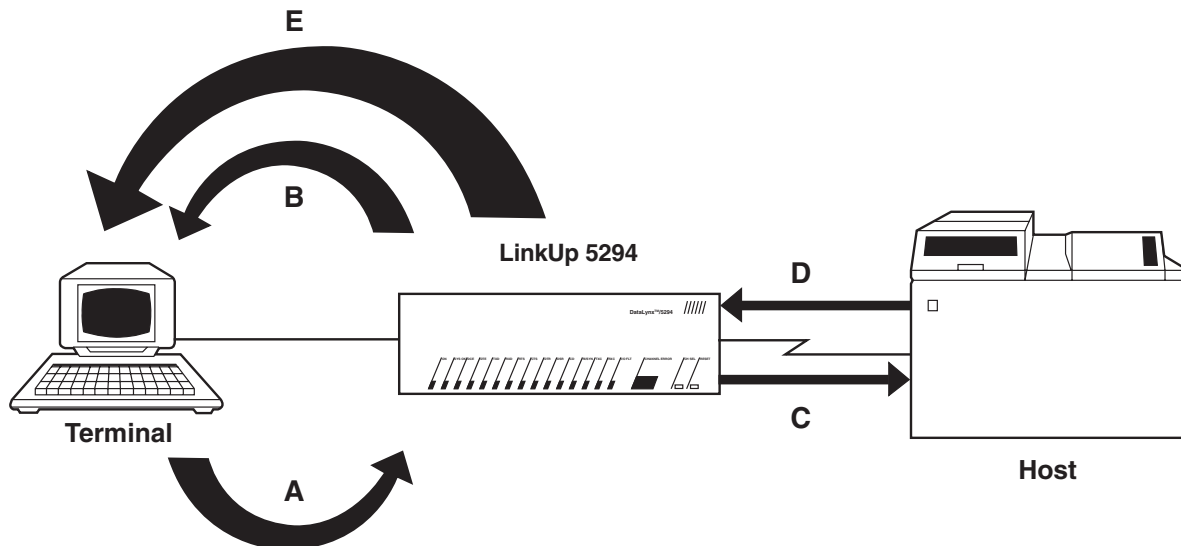

Figure 8-4. AID Key Echo.

When using PADs, a transmission delay can occur between the terminal and the LinkUp 5294. If there is a delay between the time you press the <CMD 3> key and the time the LinkUp 5294 locks the keyboard, it is possible for you to continue typing. You are ahead of the host computer, which is going to send cursor-positioning information. The cursor-positioning information goes to the terminal and moves the cursor to a location which is different from where you left it.

8.3 Installation Considerations

Packet Data Network support can be configured for any asynchronous port of the LinkUp 5294. To enable PDN support, set the value for Async Port parameter 12 to one of the following values as determined by the network type and function required.

- **12=1** Local PAD echo of characters with explicit cursor positioning sequences. This is generic PDN support. This ensures cursor synchronization at the expense of your having to wait for the LinkUp 5294 response after each press of the cursor key. Otherwise, data may be garbled.
- **12=2** Local echo with local cursor echo. This is the same generic support as Option 1, but without the LinkUp 5294 echo of cursor movement keys. The PAD itself will echo the cursor movement keys.
- **12=3** Local echo with local cursor echo. This is for use with the Telnet network because proprietary PAD control sequences are used.

The Async Port menu Option 13, Auto Exit Enabled, may be disabled (set to N) to avoid cursor positioning problems that may occur when typing beyond the end of a field.

The host PAD should be optioned for DCE and the LinkUp 5294 as DTE. The LinkUp 5294 expects to see ring indicate on Pin 22 for an incoming PDN call and will raise DTR on Pin 20 in response. The PAD should drop Pin 6 (DSR) to indicate the end of a connection so that the LinkUp 5294 will initiate session termination as configured. Ensure that the host PAD will provide these modem simulation functions.

When the LinkUp 5294 is used with X.25 networks, some screen display problems may result. If the initial port configuration is done while connected to the network, you will at first encounter locally echoed passwords and duplication of characters. However, once the port is configured and you have exited to Connect Mode, local character echo will cease. Double echo will not occur during subsequent configurations since the LinkUp 5294 will turn off its own echoplex during reconfiguration.

8.3.1 PAD PARAMETERS

The X.25 host PAD should be optioned for no character echo, editing not used, and data forwarding after 20 milliseconds of inactivity. Option codes and their subscriptions are as follows:

1:0	No escape to PAD mode
2:0	No local echo
3:0	No character forwarding
4:2	Packet forwarding after 20 ms
5:1	LinkUp 5294 accepts X-ON/X-OFF from PAD
6:0	Suppress PAD messages
7:0	Ignore break from LinkUp 5294
8:0	Normal data delivery
9:0	No padding after CR
10:0	No line folding
11:x	Baud rate (x corresponds to LinkUp 5294 port)
12:1	PAD accepts X-ON/X-OFF from LinkUp 5294
13:0	No LF insertion
14:0	No padding after LF
15:0	No editing
16-22:0	No editing

Setup options for the remote terminal PAD include local echo, no line editing, data forward on <Enter>, and data forwarding after 20 milliseconds of keyboard inactivity.

For a dedicated PAD these options are normally fixed at the time of installation. If a public network is used, a subscriber profile is generally created by the network to set the remote PAD options at the time the user requests connection. These options should be communicated to the PDN carrier at the time of subscription. Option codes and their descriptions are as follows:

1:1	Terminal can escape to PAD mode
2:1	Echo input
3:2	Forward on CR
4:2	Packet forwarding after 20 ms
5:1	Accept X-ON/X-OFF from PAD
6:1	Send PAD messages to terminal
7:0	Ignore break from terminal
8:0	Normal data delivery
9:0	No padding after CR
10:0	No line folding
12:1	PAD accepts X-ON/X-OFF from terminal
13:0	No LF insertion
14:0	No padding after LF
15-24:0	No editing

8.4 Special Operational Considerations

During operation of a terminal through a PDN to the host computer, some characters and commands are echoed locally and are reflected on the terminal screen quickly. Others must be sent through the network to the host, processed, and sent back through the network before they are observed. In general, alphanumeric characters will echo immediately. The following functions must be processed by the host or the LinkUp 5294 and will take one to three seconds:

- Field Advance using <TAB>, <BACKTAB>, <FIELD EXIT>, <FIELD +>, or <FIELD -> Keys
- Cursor <HOME> and <NEW LINE>
- <CLEAR>
- Reset (usually <CTRL/R>)
- , <ERASE INPUT> and those alphanumeric characters typed while in insert mode
- <Enter>, <ROLL UP>, <ROLL DOWN>, and <DUP>
- <SYS REQ> and <ATTN>
- <CMD> key sequences
- <SCREEN REFRESH> is useful if you suspect that the screen data may have been corrupted.

Also, when using one of the generic PNA options (1 or 2), nondisplay fields such as passwords will display due to local echo by the PAD. <SCREEN REFRESH> should be entered immediately after keying data in a non-display field, causing the LinkUp 5294 to remove it from the display. Other fields may then be completed as needed.

8.5 Other Special Considerations

8.5.1 SCREEN DISPLAY ERRORS

Because of local PAD echo, the terminal display may become garbled at times. To correct this condition, should it occur, use the <SCREEN REFRESH> sequence for your terminal. For most terminal types, this is accomplished by a <CTRL/W> or an <ESC W>. Refer to the Terminal User's Handbook for the correct key sequence for your terminal type.

If the initial LinkUp 5294 port configuration is done while connected to the network, you will encounter locally echoed passwords and duplication of characters since the LinkUp 5294 default for PNA access is N (None). Once the port is configured, exit to Connect Mode, complete the connect sequence, and screen data should appear normally thereafter.

You should not observe double echo during subsequent configurations since the LinkUp 5294 will turn off its own echoplex during reconfiguration.

8.5.2 DATA FORWARDING TO THE PAD

Customers using PADs at remote locations to connect terminals to the PDN should check to see if the PAD supports escape forwarding. This capability recognizes an escape sequence from a terminal, does not echo it, and forwards the packet to the LinkUp 5294 after a specified time period. If possible, this method of data forwarding should be used to lessen the conflict of PAD echo and LinkUp 5294 echo of control sequences.

9. Diagnostics

The first two sections of this chapter review the on-line and off-line diagnostic capabilities of the LinkUp 5294. The third section will help you find and solve common problems you may encounter when you use the LinkUp 5294.

9.1 On-Line Diagnostics

The on-line diagnostic capabilities of the LinkUp 5294 include:

- Watchdog Timer
- Error Code displays
- Communication Line Status Indicators
- Remote Interface Signal Display
- Sync Port Address Trace
- Async Port Trace
- Sync Port Trace (deluxe model only)

The Watchdog Timer enables the LinkUp 5294 to monitor its own program execution continuously in the background of daily operations, assuring you of its overall system integrity. If a program execution fails, the LinkUp 5294 alerts you with an Error Code display. Error Code displays and Communication Line Status indicators are the LinkUp 5294 front panel LEDs. Each one of these will be discussed in the next two sections.

9.1.1 FRONT-PANEL ERROR CODES

If a program-detectable error occurs, all channel status indicators on the front panel are turned off and a two-level error code is displayed by the two-digit channel display. The two error codes are flashed alternately. Table 9-1 describes the error code assignments currently implemented in the LinkUp 5294.

When an error code is displayed, pressing the RESET button will clear the error code and cause channel status display to resume. However, if more than one error has occurred, pressing RESET will clear the most recent error code and display the previous one. Preceding error codes can then be viewed by pressing RESET repeatedly until the channel status indicators resume their normal operation. This marks the end of accumulated errors. Once error codes are cleared, they cannot be redisplayed on the front panel.

9.1.2 FRONT-PANEL STATUS INDICATORS

The LinkUp 5294 front panel lets you monitor a total of 13 different communication line status indicators for any port. If a problem occurs on one of the communication lines established on one of the LinkUp 5294 ports, you can troubleshoot that problem by scrolling to the affected port number (using the CHannel SElect control button) and then examining the displayed status indicators. If the appropriate status indicators are not lit, you will be able to target the line's problem by trial and error.

Check the lights on the LinkUp's front panel when you have a communication-line problem. By comparing which signals are lit to which signals should be lit, you may be able to isolate the problem. For your reference, Table 9-2 lists the front-panel signals, their definitions, and a brief explanation of when each should be lit.

Table 9-1. Front Panel Error Codes

CLASS	FIRST CODE	SECOND CODE	DEFINITION
Hardware Deficiency	HA	00	Insufficient EEPROM for this configuration.
	HA	01	Insufficient RAM for this configuration.
System Errors	Sy	00	CPU failure: watchdog timer timeout
	SY	01	ROM failure: bad ROM cartridge.
EEPROM Chip Error	EE	01 through 04	EEPROM chip defective. Chip number is identified by the second code.
System Parameter Error in EEPROM	SP	00	EEPROM Header Error. Some or all parameters stored in EEPROM may be restored to default values. This error occurs when unformatted EEPROM chips are encountered when the LinkUp 5294 is turned on.
	SP	01	EEPROM failure in System section. Default values are loaded.
Port Parameter Error in EEPROM	Po	00 through 33	EEPROM failure in Port Parameters. Second code indicates port number. Default values are loaded for the defective port.
Logical Unit Parameter Error in EEPROM	LU	02 through 33	EEPROM failure in LU parameters. Second code indicates LU number. Default values are loaded for the defective item.
Stack Overflow	LS	02 through 33	Logical Unit Stack overflow. Second code indicates the LU number.

Table 9-2. Front Panel Communication Line Indicators.

INDICATOR	DESCRIPTION
DCE	Data Communications Equipment. Lit when the LinkUp 5294 has been logically configured (in Configuration Mode) to implement a DCE device.
DTE	Data Terminal Equipment. Lit when the LinkUp 5294 has been logically configured (in Configurator Mode) to implement a DTE device.
TxD	Transmit Data. Lit when a DTE device (or configured port) is transmitting data to an attached DCE device (or configured port).
RxD	Receive Data. Lit when a DCE device (or configured port) is transmitting data to an attached DTE device (or configured port).
RTS	Request To Send. An RS-232C signal. Lit when a DTE device (or configured port) is sending this signal to a DCE device (or configured port).
CTS	Clear To Send. An RS-232C signal. Lit when a DCE device (or configured port) is sending this signal to a DTE device (or configured port).
DTR	Data Terminal Ready. An RS-232C signal. Lit when a DTE device (or configured port) is sending this signal to a DCE device (or configured port).
DSR	Data Set Ready. An RS-232C signal. Lit when a DCE device (or configured port) is sending this signal to a DTE device (or configured port).
CD	Carrier Detect. An RS-232C signal. Lit when a DCE device (or configured port) is sending this signal to a DTE device (or configured port).
RI/SYN	Ring Indicate/Synchronized. A dual-function indicator: (1) An RS-232C signal. Lit when a DCE device (or configured port) receives a ringing signal and notifies the attached DTE device (or configured port) of this; or (2) lit during a synchronous operation when the transmitted data is synchronized.
TxC	Transmit Clock. Lit when synchronous transmit clock signals are detected by a DCE device (or configured port).
RxC	Receive Clock. Lit when synchronous receive clock signals are detected by a DCE device (or configured port).
I/O FAULT	Input/Output Faults. Flashes whenever the LinkUp 5294 detects framing, overrun, or parity errors.

9.2 Off-Line Diagnostics

The Off-line diagnostic capabilities of the LinkUp 5294 include:

- Self diagnostics at power up
- Monitoring of LU and Port Assignment Status
- Character Display Test
- Character Echo Test
- Product Configuration and Levels display
- LU and Async Port Summary (deluxe model only)
- SNA/SDLC Counters (deluxe model only)

9.2.1 SELF DIAGNOSTICS

Prior to the execution of the continuous background testing by the LinkUp 5294 Watchdog Timer, a series of preliminary self-tests is performed every time your LinkUp 5294 unit is powered on. These tests enable the LinkUp 5294 to assure you that its vital parts (ports, memory, programs, etc.) are in working order.

During the power-on self-tests all the front panel LEDs are off and **dr** is displayed on the CHANNEL/ERROR LEDs. The LinkUp 5294 usually remains in this condition for approximately three seconds; it then returns to its normal front-panel LED displays, ready for operation. (The default port number displayed on the CHANNEL/ERROR LEDs is always 02.) If one or more of the internal tests fails, **dr** will remain in the CHANNEL/ERROR display and the front panel LEDs will indicate the nature of the failure. The coding is depicted in the list below.

- DCE LED Off — Watchdog Timer Error
- DTE LED Off — ROM Test Failure
- TXD LED Off — Data Bus Failure
- RXD LED Off — Address Bus Failure
- RTS LED Off — RAM Test Failure
- CTS LED On — At least 512K of RAM
- DTR LED Off — Sync 8530 Failure
- DSR LED Off — Async 8530 Failure
- DCD LED Off — Insufficient EEPROM

9.2.2 LU AND PORT ASSIGNMENT STATUS

When you type STATUS at the Enter Item To Be Configured prompt while in Configurator Mode, the LinkUp 5294 responds by displaying a table containing the current operating status and port assignments of all 32 Logical Units. The information provided in this table enables you to isolate, at a glance, most interface problems you may encounter while operating the LinkUp 5294.

NOTE

A similar table is accessible during Connect Mode by typing <?> in response to the Enter LU Number prompt.

To interpret the information contained in this table, refer to the following definitions:

- **LU Type** — Corresponds to the system LU Type 7 (display) or 4 (SCS printer).
- **Status** — The operating state of each LinkUp 5294 LU; for example, P for an LU which is pending disconnection, D for an LU which is disconnected, I for one being used, R for one that has been disconnected but can be reconnected, and U for an undefined LU.
- **Sync Port** — Refers to the synchronous port each LU is assigned to, such as Port 0 or 1.
- **Sync Link #** — The SDLC Link Number each LU has been associated to within its assigned synchronous port; for example, Link 0 or 1.
- **LSID** — The System/3X Local Station ID number associated with the LinkUp 5294 LU; for example, any value from 0 to 9, 0A to 0F.
- **Async Port** — The asynchronous port which the LU is coupled with; Port 2 through Port 33.

9.3 Finding and Identifying Problems

For assistance in troubleshooting the LinkUp 5294, see the list below. Common problems are listed in bold, followed by possible solutions.

A directly attached terminal does not communicate with the LinkUp 5294:

1. Verify that the terminal in question is optioned compatibly with the settings of the LinkUp 5294 port it is attached to. That is, set the terminal's bit rate, parity, on-line mode, char. mode, full duplex, DTR on, DSR off, etc., to match the settings specified for the LinkUp 5294.
2. Make sure the RS-232C cable is connected to the proper port of the terminal, usually labeled as COM or MODEM.
3. Check the front-panel signal LEDs on the LinkUp 5294 to be sure RTS, CTS, DTR, DSR and CD are on. If this is not true:
 - A. Confirm that the attaching cable supports at least Pins 1–8 and 20.
 - B. Verify that the cable is not a crossover or modem cable.
 - C. Swap the cable in use with one known to be in working order.
4. Make sure the asynchronous port is optioned for DCE; that is, that it is a direct connection. Verify that the flat reversible cable of the I/O card is also installed for a DCE interface (the DCE label should be visible).

A remotely attached terminal or printer does not communicate with the LinkUp 5294.

1. Ensure that the terminal/printer, the LinkUp 5294, and modems are all configured to support the same baud rates.
2. Make sure the modem attached to the LinkUp 5294 is configured as follows:
 - A. To ignore modem commands.
 - B. Not to echo received characters.

For switched lines, the modem must also be configured as follows:

- C. An auto-answer modem must pass RI (Ring Indicator, Pin 22) to the LinkUp 5294, and allow the LinkUp 5294 to raise DTR in response to RI.
- D. Loss of Carrier Detect must be enable. (causes modem to drop DSR if line becomes disconnected).
- E. External DTR must be enabled, (Data Terminal Ready, Pin 20) control. Causes modem to disconnect from phone line if the LinkUp 5294 drops DTR.
3. The LinkUp 5294 requires RI (Ring Indicator) when used with auto-answer modems.
4. Make sure the asynchronous port of the LinkUp 5294 is configured as DTE (a remote connection).

The Host does not poll the LinkUp 5294.

1. Confirm that the host is on-line.
2. REMOTE CONNECT: Make sure the Sync port is configured for DTE. Also make sure that the BIT RATE is set for EXT.
3. DIRECT CONNECT: Make sure the Sync port is configured for DCE. Also make sure the BIT RATE is set for a specific rate (in keeping with the host configuration).
4. Review the LinkUp 5294 Sync port configuration with that of the Host systems. Pay particular attention to Control Unit Address, HALF/FULL DUPLEX, NRZI, and CLOCKING.
5. Ensure that the RS-232C cable for the Sync port has, at a minimum, the following Pins: 1 through 8, 15, 17, 20, and 22.
6. Ensure that a hardware reset has been performed since the last synchronous port changes were made.

The Host is polling the LinkUp 5294, but the terminal does not receive a sign-on screen. Or instead, a 0099 error occurs.

1. Confirm that the host is indeed on-line. If yours is a remote connection, this necessitates calling the host and the LinkUp 5294 site.
2. Normally this means the LU (Logical Unit) you are trying to access the Host through has not been assigned to a valid Host Workstation ID. This may be because:
 - A. The valid Host address (LSID) has not been assigned to the LinkUp 5294 Logical Unit (LU) through the LinkUp 5294 Configurator Mode.
 - B. The Host address (LSID) assigned to the LinkUp 5294 Logical Unit (LU) has not been assigned on the host system (meaning it is an invalid LSID).

- C. The LinkUp 5294 Logical Unit was assigned to the incorrect Control Unit emulation (that is, to SDLC Link Address).
- D. A hardware reset has not been performed since the last synchronous port changes were made.

Once host sign-on screen appears and sign-on is entered, the host does not respond.

1. Make sure the correct key sequence for <Enter> is pressed.

The data displayed on the terminal screen is garbled or unintelligible.

1. Make sure the Terminal Module ID you entered at the Device Type prompt (or in Configurator Mode, if this port parameter is defined as overridable) is the correct module ID for your terminal or terminal emulator.
2. Ensure that every device on the suspect communication line has compatible settings for character and parity bits.

10. Emulation Capabilities

The LinkUp 5294 emulates an IBM 5251 model 12 Remote Workstation Controller, 5294 or 5394 Remote Cluster Controller. It is designed with a variety of Terminal and Printer Modules to let virtually any ASCII terminal or printer communicate with an AS/400 host computer as if it were actual IBM 5251 model 11 or 529x Workstation or 52xx Printers.

10.1 5250 Display Emulation

Each of the Terminal Modules supports all of the 5250 screen handling facilities of an actual 5251 model 11 or 529x workstation. This includes cursor-positioning and display attributes such as:

- Reverse Image
- Nondisplay
- Blink
- Column Separator
- High-intensity
- Underscore

The above attributes are supported only to the extent that your ASCII terminal can support them.

The LinkUp 5294 also uses many special techniques to optimize the emulation provided to your ASCII terminal:

- **Screen Optimization** — Instead of clearing and repainting your screen's data for every update, the LinkUp 5294 updates your screen by clearing and repainting only for new character changes, keeping the amount of screen updating to a minimum.
- **Terminal's Unique Features** — These are incorporated into the corresponding Terminal Module if they are proven advantageous. If not, the LinkUp 5294 compensates. To prevent those ASCII terminals with automatic scrolling capabilities from automatically scrolling, since an actual IBM workstation does not support this, the LinkUp 5294 restricts data from being entered to the last character position (row 24, column 80) on the terminal's screen.
- **Status Line** — Five indicators are displayed on row 24 of your terminal's screen while you are in session with the System/3X host (Emulation Mode). The LinkUp 5294 displays this line the first time your terminal enters Emulation Mode; afterwards, you may toggle it on (or off) using the appropriate key sequence (corresponding to the function of Toggle Status Line/Toggle Indicators.) These five indicators are listed below:

SYS AVAIL — System Available indicator is set (turned on) whenever the terminal is receiving polls from the System/3X host.

MSG WT — Message Waiting indicator, controlled by the host, is set (turned on) whenever you have messages waiting to be read.

INS MODE — Insert Mode indicator is set (turned on) whenever the INSERT key has been pressed. Insert Mode can be reset (turned off) by pressing the ERROR RESET or one of the Aid Generating keys.

INPUT INH — Input Inhibited indicator is set (turned on) after an Aid Generating key is pressed. This indicates the keyboard has been locked by the host and the operator should not type any data.

The System/3X host will reset (turn off) this indicator after it has completed the requested data processing. (Operator errors will also set this indicator.) Only SYS REQ and ATTN are valid while input is inhibited.

AWFER — Awaiting Field Exit Required indicator is set (turned on) when data is entered into the last position of a field that the host has marked as requiring the function of Field Exit to be invoked. It is reset once the field is exited. (On an actual Model 11 workstation the cursor blinks to indicate AWFER.)

- Support for a 25th-line Status Line display is available for the following terminals: Hazeltine® Esprit™ 10/51, Lear Siegler® ADM-ii, TeleVideo® 925, Wyse® 30, Cybernex XLB-5291, Rebus 3000, and FileLynx®/5251. The status display is exactly the same as it had been on Line 24, and the Toggle Status Indicators keystroke is accessed in the same manner.

Because of design characteristics of the Wyse 30 and the Cybernex XLB-5291, the ERROR nnnn-mmmm portion of the Status Line in columns 64 through 79 of the 25th line is sometimes unable to display at the proper times. As this part of the Status Line is displayed only in the event of an error between the LinkUp 5294 and the System/3X this limitation should be of little or no consequence to you.

NOTE

Although the Status Line displays on Row 24, the LinkUp 5294 does not cause normal data to be lost at its expense. Instead, whenever the host or terminal operator attempts to write data to that row, the LinkUp 5294 automatically turns the Status Line off and displays the normal data.

10.2 5250 Keyboard Functions

Most of the 5250 keyboard functions are implemented by the LinkUp 5294 modules in a manner most suited to the keyboard layout of the particular terminal the module is designed for. See **Appendix G** for the module-specific key sequences of each function.

These are the 5250 keyboard functions supported by the LinkUp 5294:

Cursor Movement Keys

- **Character Backspace** moves the cursor left one position, while always keeping the cursor in a non-bypass field. If the cursor is at the beginning of a field, pressing this key moves the cursor to the last position of the previous non-bypass field.
- **Cursor Up/Down** moves the cursor vertically one line, wrapping around the screen if necessary.
- **Cursor Left/Right** moves the cursor horizontally one space, wrapping to the next or previous row if necessary.
- **Cursor Fast Left/Fast Right** causes the cursor to move horizontally three spaces, wrapping to the next or previous row if necessary.
- **Field Advance** positions the cursor at the start of the next unprotected field, wrapping around the screen if necessary.
- **Field Backspace** moves the cursor to the start of the previous non-bypass field.
- **New Line** positions the cursor at the start of the first non-bypass field on the next line.

Special Control Keys

- **Delete** deletes the character over the cursor and moves all remaining characters in the field one position to the left.
- **Erase Input** clears all non-bypass fields you have modified.
- **Error Reset** clears your terminal of the following conditions: (1) insert mode, (2) error messages, usually displayed on row 24, or (3) a system request state, as when SYS REQ is pressed.
- **Home** moves the cursor to the position defined by the host as home. Usually, this is the start of the first field on the screen. If the cursor is already at this position, the key performs a Record Backspace function, which requests a display of the previous record in a file or database.
- **Insert** sets the insert mode for the current field. Insert must be reset before you can exit the field.

Field Exit Keys

- **Duplicate** causes duplicate characters (displayed as asterisks on ASCII terminals) to be written from the cursor position to the end of the field.
- **Field Exit and Field Plus** perform the same function; they erase all characters to the end of a field, then move the cursor to the next non-bypass field. If invoked on a signed-numeric field, they also write a null to the sign position of the field, creating a positive number, and when invoked in right-adjust fields they align the data entered to the field to the right.

NOTE

Most of the Terminal Modules support only EXIT.

- **Field Minus** is only valid in signed-numeric and numeric-only fields. It generates a negative number by writing a hyphen to the sign position in the case of a signed-numeric field; for a numeric-only field, the last character of the field is changed from a digit to an alpha character (D-zoned) to signify a negative number.

Aid Generating Keys

- **Clear** is application-specific, but is usually used to clear the screen.
- **Enter Rec/Adv** transmits the data entered on the screen to the host.
- **Help.** When used while an error (0005, etc.) is displayed, this key requests information on the error that occurred; otherwise, its actions depend on the application you are in.
- **Command Function Keys 1-24** are entirely application-specific, but usually CMD 7 cancels the current application and CMD 3 displays the previous screen (except on a System/34).
- **Print** prints the contents of your screen to the console's default printer.
- **Roll Up/Down** is also application specific, but is usually used to roll the data up or down; that is, to select the previous or next page of text.

Special Host Keys

- **System Request** allows you to sign onto a System/34 host only, or to toggle between Console and Subconsole Modes for each of the System/3X hosts, providing the workstation is so configured.

Signal Key

- **Attention** is often used to terminate the currently running program.

10.3 LinkUp 5294 Extended Keyboard Functions

The following eight extended keyboard functions are specific to the LinkUp 5294. See **Appendix G** for the module-specific key sequences of each function.

- **Local Copy Print Request** prints the contents of your screen to a printer configured and assigned to your terminal (in the LinkUp 5294) as a Local Copy printer.
- **Local Copy Form Feed** sends a form feed command to the printer configured and assigned to your terminal (in the LinkUp 5294) as a Local Copy printer.
- **Cancel Print** cancels a print request sent to a printer configured and assigned to your terminal (in LinkUp 5294) as a Local Copy printer.
- **Refresh Screen** redisplay the last transmitted CRT screen from the screen buffer stored within the LinkUp 5294. This key is useful when your terminal's display is garbled due to line errors.
- **Toggle Status Line/Toggle Indicators** toggles the display of the LinkUp 5294 status line of five indicators (discussed in **Section 1.1**).
- **Toggle Echoplex Enabled** toggles the ability of the LinkUp 5294 to echo characters to your terminal's screen, providing this toggle has been configured in the LinkUp 5294.
- **Initialize Terminal** causes the terminal to reinitialize without resetting the LinkUp 5294 port your terminal is attached to. In other words, you are exited from the System/3X host session (referred to as Emulation Mode) and returned to the LinkUp 5294 sign-on menu (referred to as Connect Mode) even if the LinkUp 5294 has been configured to suppress this screen. When this function is invoked, the host is informed that the workstation's power has been turned off.
- **Request Disconnect** is similar to Initialize Terminal in that it exits you from the AS/400® host session (Emulation Mode). However, unlike Initialize Terminal it resets the LinkUp 5294 port your terminal is connected to. When your terminal is connected to the LinkUp 5294 by a modem, this function will cause the modem to hang up, disconnecting your terminal. Again, when this function is invoked the host is informed that the terminal has been powered off.

10.4 Printer Support: System vs. Local Copy

As previously mentioned, each of the Printer Modules enables ASCII printers to appear to the System/3X or AS/400® host as though they were actual IBM 5224, 5225, or 5256 Printers. The operational mode of these modules can be defined as a System printer or as a Local Copy printer.

A System printer is one that accepts print jobs from the System/3X or AS/400 host. A Local Copy printer is one which accepts a command from you to print the contents of your terminal screen. To invoke a local copy print request, you must press the special key sequence (appropriate to your selected Terminal Module) corresponding to the extended function of Local Copy Print Request.

If the following conditions are not met, a Local Copy Print Request will be ignored and no error message will display:

- The printer must be defined in the LinkUp 5294 as a Local Copy printer.
- The defined Local Copy printer must be associated to your terminal (either by your system operator or by your sign on to the LinkUp 5294 during Connect Mode).
- The printer must not be currently printing another terminal operator's screen (if the same printer is assigned to more than one terminal).

11. Hardware and Software Requirements

This chapter describes the various ASCII terminal and printer types supported by the LinkUp 5294 and recommends which Terminal and Printer Module to use with each. General switch or configuration settings for your terminal, printer, or modem (if a remote connection must be established with the LinkUp 5294) are also reviewed.

11.1 ASCII Terminals

The following list identifies the ASCII terminals currently supported by the LinkUp 5294. Additionally referenced are the Terminal Module IDs recommended for use with each terminal listed.

Once you have identified the Terminal Module appropriate for your terminal, see **Appendix G** for that module's list of key sequences for invoking the 5250 and extended keyboard functions. If the terminal you wish to use is not listed, please call your supplier to verify whether it is supported, and if it is, how.

Manufacturer	Terminal	Module ID
ADDS®	Regent® and Viewpoint Viewpoint 60	VIEWP VP60
AMPEX®	210/230 219	TV925 VT100
Anderson Jacobson®	AJ-520	VT52 or VT100
ANSI Standard 3.64	Any ANSI Standard 3.64 compliant terminal	ANSI
Beehive®	ATL-008	VT100
C-Itoh®	101 C7101 C7103	VT100 C7101 C7103
Colorgraphic	MVI-100	VT100
Cybernex	XLB-5291	CY5291
Data General	DASHER® D100/D200	D200
Datamedia	DT80/1,DT80/2 DT80/3 DT80/5 Colorscan 10	VT100 TV925 VT100 VT100

LINKUP 5294 WITH DL5294 FIRMWARE

Manufacturer	Terminal	Module ID
DEC™	VT52™ VT100™/VT101™ VT102™/VT125™/VT131™ VT220™/VT240™	VT52 or VT52X VT100 VT220
Direct	VP800C	VT100
Falco	TS-1 Fame-100 Fame-II	VT52 VT100 ANSI
Hazeltine	Esprit Esprit III Esprit 10-51	ADM3A TV925 HZSI
Hewlett-Packard	HP®-2621AJ2645	HP45
IBM	3101 3151 316V3163 3164	I3101 I3151 I3161 I3164
Informer	30V401	VT52 or I3101
KDE	802	VT52
Lear Siegler	ADM-3A ADM-5 ADM-II ADM-21/22/23/24 ADM-36 ADM-42	ADM3A ADM3P ADMII ADM21 VT100 ADM3P
Liberty Electronics	Freedom® 100	TV925
MicroTerm	ACT-SA MIME-2A MIME-740/Ergo 4000 Ergo 201 Ergo 301	ACTSA VT52 VT100 VT52 or TV925 VT52 or VT100
MVI	7	VT100
NCR®	7901	VIEWP
Northern Telecom	Displayphone	DISPH
QUME®	QVT-102	ADM3A
Radio Shack®	DT-1	TV910
Rebus	3000	REBUS
Scanset	Scanset	SCANS
Soroc™	IQ120	IQ120

Manufacturer	Terminal	Module ID
TAB	132	VT52
	132/15	VT100
TELERAY®	VT52	
TeleVideo	910	TV910
	910 + /912	TV91OP
	920/925/950	TV925
	970	TV970
	Personal Terminal	TV910
Telex	310	I3101
Visual	100/300/400	VT100
	110	D200
	50/200	ADM3A or VT52
Wyse	WY-100	WY100
	WY-30	WY30
	WY-60	WY60
	WY-60 w/extended keyboard	WY60X
Xpoint	Remote 91	HZS1
Zenith®	Z-19	VT52 or VT100
	ZT-1	VT52
Zentec	Zephyr	TV925

For those terminals whose switch settings are not explicitly detailed in **Appendix G**, the following general terminal settings are recommended:

- Character Mode = ON (as opposed to Block or Line Mode)
- Full Duplex = ON
- Auto New Line = OFF (if switch-selected)
- Auto Line Feed = OFF
- Cursor addressing = ON
- Auto Scroll = OFF (if switch-selected)
- DTR and DCD = ON, DSR = OFF (if switch- selected)
- Baud Rate = LinkUp 5294 configured settings
- Word Length (i.e., Data Bits, Parity, and Stop Bits) = LinkUp 5294 configured settings (most commonly implemented as 8 data bits, no parity, and 1 stop bit)
- Keyboard must be decoupled from the display (if switch-selected)

NOTE

The LinkUp 5294 must handle all screen changes to your terminal. Set your terminal so that whenever you press a key on your keyboard its character is transmitted directly to the LinkUp 5294, rather than to the terminal's display. This setup is called Conversational Mode. If your terminal's keyboard cannot be decoupled from its display (Conversational Mode = ON), then avoid using those keys which locally affect the display. If you do not, the result is a garbled display, requiring you to invoke the LinkUp 5294's extended keyboard function for Refresh Screen.

11.2 Personal Computers and Word Processors

The LinkUp 5294 also enables Personal Computers (PCs) and Word Processors (WPs) to emulate 5250 display workstations. However, in order for the LinkUp 5294 to accomplish this, the PCs and WPs must be equipped with software enabling them to emulate one of the ASCII terminals supported by the LinkUp 5294.

The following list identifies a variety of PCs and WPs currently supported by the LinkUp 5294, plus suggested terminal emulation software packages for each. Also listed are the Terminal Module IDs recommended for use with each of the suggested software packages.

Once you have identified the Terminal Module appropriate for your PC or WP, see Appendix G for the corresponding list of key sequences specified for that Module, enabling you to invoke the 5250 and extended keyboard functions. If the PC or WP you wish to use is not referenced, please check with your supplier to verify whether it is supported and, if it is, how.

Computer	Software Package	Module ID
Apple® IIe/IIc	Softterm Package	ADM3P
Apple III	Apple Access III	ADM3P
Apple Lisa	Included with Lisa	VT100
AT&T 6300	Andrew Corporation IBM PC Program	IBMPC or T5250
Columbia	Andrew Corporation IBM PC Program	IBMPC or T5250
COMMODORE® 64	VIP Terminal Emulator Softlaw Corp	VT52
COMPAQ®	Andrew Corporation IBM PC Program	IBMPC or T5250
CPT	CPT VT52 Package	VT52
DEC Rainbow™ VT180	Comm. Package from DEC	VT100
Direct	Included in computer	VT100
EXXON®	EXXON TV925 package	TV925
Fortune	ITE package	TV925

HP-200 series	HP Terminal Emulator program	HP45
IBM PC	IBM PC Program	T5250
IBM AT®	IBM PC Program	T5250
Computer	Software Package	Module ID
IBM PC Convertible	IBM PC Program	T5250
IBM PC Jr.	IBM PC Program	T5250
Kaypro®	Superterm Package	ADM3P
Leading Edge® PC	IBM PC Program	T5250
Radio Shack Model-II	Radio Shack ADM3A Emulator	ADM3P
Sperry PC	IBM PC Program	T5250
TIProf. Comp.	Octacomm/PCHouston	VT100
Toshiba® 3100	IBM PC Program	T5250
Vector Graphic	Gulf Data ADM3A Package	ADM3P
Victor® 9000	ASCOM Async Package	ADM3A
Xerox® 820	ASCOM Async Package	ADM3P
Xerox 820-II	Included with computer	ADM3P
Zenith Z-89/90/100	Zenith Terminal Package	VT52
Zenith Z-150	IBM PC Program	T5250

11.3 Auxiliary Attached ASCII Printers

Some terminals and PCs are equipped with an auxiliary port (serial or parallel) to which you may attach an ASCII printer. The LinkUp 5294 supports this application through a special Auxiliary Printer facility. This facility enables your terminal or PC and its attached auxiliary printer to share a single port on the LinkUp 5294 and still be separately addressed by the System/3X host. This is accomplished by interleaving the data between both devices, with the terminal or PC having priority over the printer.

As far as the LinkUp 5294 or the System/3X host is concerned, an auxiliary printer is no different from a printer which is actually directly connected. With the help of the LinkUp 5294, the auxiliary printer can also emulate one of the IBM 52xx Printers as either a System or Local Copy printer.

LINKUP 5294 WITH DL5294 FIRMWARE

The following ASCII terminals and PCs will support an auxiliary printer:

ADDS Viewpoint and Viewpoint 60
Beehive DM-20
C. Itoh 7101 and 7103
Cybernex XLB-5291
DEC VT52, VT52X, VT100 (VT102),VT220
Hazeltine 10/51
IBM 3151, 3161, 3163, 3164
IBM Personal Computer
Lear-Siegler ADM-3A, ADM-21, ADM-1 1
Microterm ACT-5A
Rebus 3000
Soroc® IQ120
TeleVideo 910, 910 Plus, 925, 970
Tymshare Scanset
Wyse 30, 6S), 100

The following list identifies the ASCII printers currently supported by the LinkUp 5294. In the right-hand column, you will find the printer module recommended for each printer.

Manufacturer	Model	Module ID
Centronics®	351 or 359	CENTRN
C. Itoh	300 or 600	CI300
Data Products	SPG8050	DP8050
General Electric	GE3000	GE3000
Genicom	3410 4410, 4440	GEN34 GEN44
Epson	RX/FX/MX/JX/80/100	EPSON
Hewlett-Packard	LaserJet series	HPGEN HPDPL HPDPP
OKIDATA®	MicroLine 8V83/84/9V93	OKIM84
Most others	(Generic Support)	PRINT

Three printer drivers have been included to support the Hewlett-Packard LaserJet® printers. The printer IDs for the three are:

- HPDPL - HP Data Processing Landscape mode
- HPDPP - HP Data Processing Portrait mode
- HPGEN - HP Generic

These drivers provide all the functionality of the PRINT driver and, in addition, support the SCS commands Set Line Density and Set Character Density. The need for these drivers arises from the LaserJet characteristic of not allowing any data in a border margin of approximately $\frac{1}{4}$ of an inch. This means that the usable space within the $8\frac{1}{2}$ " x 11" form is actually only about 8" x $10\frac{1}{2}$ ". To provide a full 66 lines per page capability, therefore, the data must actually be compressed further than the normal six (6) lines per inch.

The HPDPL driver provides 66 or 88 lines per page and 132 or 198 characters per line in Line Printer font.

The HPDPP driver provides 66 or 88 lines per page and 80 characters per line in Courier font or 132 characters per line in Line Printer font.

The HPGEN driver provides true 6 or 8 lines per inch and true 10 or 15 characters per inch. It should not affect the prior font or data orientation: that is, if your LaserJet was previously in Landscape and Courier, this driver will leave your printer at that state.

Not all LaserJet printers support the Line Printer font. The compression of data as performed by these drivers may yield less than the desired result. If this is the case, either Line Printer font should be made available on your LaserJet or data compression should be avoided.

If you are using an ASCII printer, be sure to confirm that the switch settings of the printer match those defined in the LinkUp 5294; for example, the RS-232C line signals for physical flow control (Not Busy Signal) and device ready (online signal), or the printer's logical flow control code.

11.4 Asynchronous Modems

When your terminal or PC (and auxiliary printer, if appropriate) are remotely located from the LinkUp 5294, they must communicate with the LinkUp 5294 over switched or dedicated lines in full-duplex mode with asynchronous modems. To assure that this remote connection is operating optimally, be sure to confirm that your modems are set up as follows:

- The DCD line state should not be held artificially high
- The modem should hang up when DTR drops.

Appendix A: EBCDIC/ASCII Translation Tables

The LinkUp 5294 automatically translates ASCII characters to EBCDIC for all communications data received from a terminal and performs EBCDIC to ASCII translation for all output to a keyboard/CRT or printer.

For keyboard input, the ASCII 0 to 1F hex values are implemented by the LinkUp 5294 as valid for 5250 keyboard function sequences only; this means they are used in a string of characters only to emulate 5250 keyboard functions, such as ENTER, CMD 1 through 24, etc.

NOTE

Sequences appropriate to these keyboard functions depend on the terminal module. See Appendix G for the sequences for your terminal.

The EBCDIC to ASCII code translations (and vice versa) are based as far as possible on character equivalence. However, in certain cases this is not possible. Accordingly, the following special translations are applicable:

EBCDIC	ASCII
¢ (4A)	[(5B)
(6A)] (5D)
¬ (5F)	^ (5E)
(4F)	(7C)

NOTE

EBCDIC values which do not have possible ASCII equivalents (other than those listed above) are translated to the ASCII question mark (3F hex).

U.S. EBCDIC to ASCII Data Translation Table

EBCDIC	ASCII
40 SP	20 SP
41	3F ?
42	3F ?
43	3F ?
44	3F ?
45	3F ?
46	3F ?
47	3F ?
48	3F ?
49	3F ?
4A ¢	5B [
4B .	2E .
4C <	3C <
4D (28 (

APPENDIX A: EBCDIC/ASCII Translation Tables

U.S. EBCDIC to ASCII Data Translation Table (Continued)

EBCDIC	ASCII
4E +	2B +
4F	7C
50 &	26 &
51	3F ?
52	3F ?
53	3F ?
54	3F ?
55	3F ?
56	3F ?
57	3F ?
58	3F ?
59	3F ?
5A !	21 !
5B \$	24 \$
5C *	2A *
5D)	29)
5E ;	3B ;
5F]	5E ^
60 -	2D —
61 /	2F /
62	3F ?
63	3F ?
64	3F ?
65	3F ?
66	3F ?
67	3F ?
68	3F ?
69	3F ?
6A	5D]
6B ,	2C ,
6C %	25 %
6D -	5F —
6E >	3E >
6F ?	3F ?
70	3F ?
71	3F ?
72	3F ?
73	3F ?
74	3F ?
75	3F ?
76	3F ?
77	3F ?
78	3F ?
79 ‘	60 ‘
7A :	3A :
7B #	23 #
7C @	40 @
7D ’	27 ’
7E =	3D =
7F "	22 "

U.S. EBCDIC to ASCII Data Translation Table (Continued)

EBCDIC	ASCII	
80	3F	?
81 a	61	a
82 b	62	b
83 c	63	c
84 d	64	d
85 e	65	e
86 f	66	f
87 g	67	g
88 h	68	h
89 i	69	i
8A	3F	?
8B	3F	?
8C	3F	?
8D	3F	?
8E	3F	?
8F	3F	?
90	3F	?
91 j	6A	j
92 k	6B	k
93 l	6C	l
94 m	6D	m
95 n	6E	n
96 o	6F	o
97 p	70	p
98 q	71	q
99 r	72	r
9A	3F	?
9B	3F	?
9C	3F	?
9D	3F	?
9E	3F	?
9F	3F	?
A0	3F	?
A1 ~	7E	~
A2 s	73	s
A3 t	74	t
A4 u	75	u
A5 v	76	v
A6 w	77	w
A7 x	78	x
A8 y	79	y
A9 z	7A	z
AA	3F	?
AB	3F	?
AC	3F	?
AD	3F	?
AE	3F	?
AF	3F	?
B0	3F	?
B1	3F	?

APPENDIX A: EBCDIC/ASCII Translation Tables

U.S. EBCDIC to ASCII Data Translation Table (Continued)

EBCDIC	ASCII
B2	3F
B3	3F
B4	3F
B5	3F
B6	3F
B7	3F
B8	3F
B9	3F
BA	3F
BB	1B
BC	3F
BD	3F
BE	3F
BF	3F
C0	{
C1	A
C2	B
C3	C
C4	D
C5	E
C6	F
C7	G
C8	H
C9	I
CA	3F
CB	3F
CC	3F
CD	3F
CE	3F
CF	3F
D0	}
D1	J
D2	K
D3	L
D4	M
D5	N
D6	O
D7	P
D8	Q
D9	R
DA	3F
DB	3F
DC	3F
DD	3F
DE	3F
DF	3F
E0	\
E1	3F
E2	S
E3	T

U.S. EBCDIC to ASCII Data Translation Table (Continued)

EBCDIC	ASCII
E4 U	55 U
E5 V	56 V
E6 W	57 W
E7 X	58 X
E8 Y	59 Y
E9 Z	5A Z
EA	3F ?
EB	3F ?
EC	3F ?
ED	3F ?
EE	3F ?
EF	3F ?
F0 0	30 0
F1 1	31 1
F2 2	32 2
F3 3	33 3
F4 4	34 4
F5 5	35 5
F6 6	36 6
F7 7	37 7
F8 8	38 8
F9 9	39 9
FA	3F ?
FB	3F ?
FC	3F ?
FD	3F ?
FE	3F ?
FF	3F ?
20 SP	40 SP
21 !	5A !
22 "	7B "
23 #	7B #
24 \$	5B \$
25 %	6C %
26 &	50 %
27 ' ,	7D ' ,
28 (4D (
29)	5D)
2A *	5C *
2B +	4E +
2C ,	6B ,
2D -	60 -
2E .	4B .
2F /	61 /
30 0	F0 0
31 1	F1 1
32 2	F2 2
33 3	F3 3
34 4	F4 4
35 5	F5 5

APPENDIX A: EBCDIC/ASCII Translation Tables

U.S. EBCDIC to ASCII Data Translation Table (Continued)

EBCDIC	ASCII
36 6	F6 6
37 7	F7 7
38 8	F8 8
39 9	F9 9
3A :	7A :
3B ;	5E ;
3C <	4C <
3D =	7E =
3E >	6E >
3F ?	6F ?
40 @	7C @
41 A	C1 A
42 B	C2 B
43 C	C3 C
44 D	C4 D
45 E	C5 E
46 F	C6 F
47 G	C7 G
48 H	C8 H
49 I	C9 I
4A J	D1 J
4B K	D2 K
4C L	D3 L
4D M	D4 M
4E N	D5 N
4F 0	D6 0
50 P	D7 P
51 Q	D8 Q
52 R	D9 R
53 S	E2 S
54 T	E3 T
55 U	E4 U
56 V	E5 V
57 W	E6 W
58 X	E7 X
59 Y	E8 Y
5A Z	E9 Z
5B [4A €
5C \	E0 \
5D]	6A
5E ^	5F ¬
5F -	6D -
60 .	79 .
61 a	81 a
62 b	82 b
63 c	83 c
64 d	84 d
65 e	85 e
66 f	86 f
67 g	87 g

U.S. EBCDIC to ASCII Data Translation Table (Continued)

EBCDIC	ASCII
68 h	88 h
69 i	89 i
6A j	91 j
6B k	92 k
6C l	93 l
6D m	94 m
6E n	95 n
6F o	96 o
70 p	97 p
71 q	98 q
72 r	99 r
73 s	A2 s
74 t	A3 t
75 u	A4 u
76 v	A5 v
77 w	A6 w
78 x	A7 x
79 y	A8 y
7A z	A9 z
7B {	C0 {
7C	4F
7D }	D0 }
7E ~	A1 ~

Multinational ASCII to EBCDIC Data Translation Table

ASCII	EBCDIC
00	00
01	6f
02	6f
03	6f
04	6f
05	6f
06	6f
07	6f
08	6f
09	6f
0a	6f
0b	6f
0c	6f
0d	6f
0e	6f
0f	6f
10	6f
11	6f
12	6f
13	6f
14	be

Multinational ASCII to EBCDIC Data Translation Table (Continued)

ASCII	EBCDIC
15	bd
16	6f
17	6f
18	6f
19	6f
1a	6f
1b	6f
1c	1c
1d	6f
1e	6f
1f	6f
20	40
21	4f
22	7f
23	7b
24	5b
25	6c
26	50
27	7d
28	4d
29	5d
2a	5c
2b	4e
2c	6b
2d	60
2e	4b
2f	61
30	f0
31	f1
32	f2
33	f3
34	f4
35	f5
36	f6
37	f7
38	f8
39	f9
3a	7a
3b	5e
3c	4c
3d	7e
3e	6e
3f	6f
40	7c
41	c1
42	c2
43	c3
44	c4
45	c5
46	c6

Multinational ASCII to EBCDIC Data Translation Table (Continued)

ASCII	EBCDIC
47	c7
48	c8
49	c9
4a	d1
4b	d2
4c	d3
4d	d4
4e	d5
4f	d6
50	d7
51	d8
52	d9
53	e2
54	e3
55	e4
56	e5
57	e6
58	e7
59	e8
5a	e9
5b	4a
5c	30
5d	5a
5e	5f
5f	6d
60	79
61	81
62	82
63	83
64	84
65	85
66	86
67	87
68	88
69	89
6a	91
6b	92
6c	93
6d	94
6e	95
6f	96
70	97
71	98
72	99
73	a2
74	a3
75	a4
76	a5
77	a6
78	a7

Multinational ASCII to EBCDIC Data Translation Table (Continued)

ASCII	EBCDIC
79	a8
7a	a9
7b	c0
7c	6a
7d	d0
7e	a1
7f	6f
80	68
81	dc
82	51
83	42
84	43
85	44
86	47
87	48
88	52
89	53
8a	54
8b	57
8c	56
8d	58
8e	63
8f	67
90	71
91	9c
92	9e
93	cb
94	cc
95	cd
96	db
97	dd
98	df
99	ec
9a	fc
9b	70
9c	b1
9d	80
9e	b3
9f	b4
a0	45
a1	55
a2	ce
a3	de
a4	49
a5	69
a6	9a
a7	9b
a8	ab
a9	af
aa	ba

Multinational ASCII to EBCDIC Data Translation Table (Continued)

ASCII	EBCDIC
ab	b8
ac	b7
ad	aa
ae	8a
af	8b
b0	6f
b1	6f
b2	6f
b3	bb
b4	6f
b5	65
b6	62
b7	64
b8	83
b9	6f
ba	6f
bb	6f
bc	6f
bd	b0
be	b2
bf	6f
c0	89
c1	e3
c2	6f
c3	6f
c4	6f
c5	8d
c6	46
c7	66
c8	e8
c9	d6
ca	96
cb	e2
cc	a2
cd	bf
ce	6f
cf	9f
d0	8c
d1	ac
d2	72
d3	73
d4	74
d5	da
d6	75
d7	76
d8	77
d9	6f
da	c9
db	c7
dc	87

Multinational ASCII to EBCDIC Data Translation Table (Continued)

ASCII	EBCDIC
dd	6a
de	78
df	93
e0	ee
e1	59
e2	eb
e3	ed
e4	cf
e5	ef
e6	a0
e7	8e
e8	ae
e9	fe
ea	fb
eb	fd
ec	a8
ed	e8
ee	bc
ef	be
f0	60
f1	8f
f2	bf
f3	b9
f4	b6
f5	b5
f6	61
f7	9d
f8	90
f9	bd
fa	4b
fb	da
fc	fa
fd	ea
fe	6f
ff	6f

Multinational EBCDIC to ASCII Data Translation Table

EBCDIC	ASCII
00	00
01	20
02	20
03	20
04	20
05	20
06	20
07	20
08	20

Multinational EBCDIC to ASCII Data Translation Table (Continued)

EBCDIC	ASCII
09	20
0a	20
0b	20
0c	0c
0d	0d
0e	20
0f	20
10	3f
11	3f
12	3f
13	3f
14	3f
15	0a
16	3f
17	3f
18	3f
19	19
1a	20
1b	20
1c	2a
1d	20
1e	3f
1f	fe
20	20
21	21
22	22
23	23
24	24
25	25
26	26
27	27
28	28
29	29
2a	2a
2b	2b
2c	2c
2d	2d
2e	2e
2f	2f
30	30
31	31
32	32
33	33
34	34
35	35
36	36
37	37
38	38
39	39
3a	3a

Multinational EBCDIC to ASCII Data Translation Table (Continued)

EBCDIC	ASCII
3b	3b
3c	3c
3d	3d
3e	3e
3f	3f
40	20
41	20
42	83
43	84
44	85
45	a0
46	c6
47	86
48	87
49	a4
4a	5b
4b	2e
4c	3c
4d	28
4e	2b
4f	21
50	26
51	82
52	88
53	89
54	8a
55	a1
56	8c
57	8b
58	8d
59	e1
5a	5d
5b	24
5c	2a
5d	29
5e	3b
5f	5e
60	2d
61	2f
62	b6
63	8e
64	b7
65	b5
66	c7
67	8f
68	80
69	a5
6a	7c
6b	2c
6c	25

Multinational EBCDIC to ASCII Data Translation Table (Continued)

EBCDIC	ASCII
6d	5f
6e	3e
6f	3f
70	9b
71	90
72	d2
73	d3
74	d4
75	d6
76	d7
77	d8
78	de
79	60
7a	3a
7b	23
7c	40
7d	27
7e	3d
7f	22
80	9d
81	61
82	62
83	63
84	64
85	65
86	66
87	67
88	68
89	69
8a	ae
8b	af
8c	d0
8d	c5
8e	e7
8f	f1
90	f8
91	6a
92	6b
93	6c
94	6d
95	6e
96	6f
97	70
98	71
99	72
9a	a6
9b	a7
9c	91
9d	f7
9e	92

Multinational EBCDIC to ASCII Data Translation Table (Continued)

EBCDIC	ASCII
9f	cf
a0	e6
a1	7e
a2	73
a3	74
a4	75
a5	76
a6	77
a7	78
a8	79
a9	7a
aa	ad
ab	a8
ac	d1
ad	ed
ae	e8
af	a9
b0	bd
b1	9c
b2	be
b3	93e
b4	9f
b5	f5
b6	f4
b7	ac
b8	ab
b9	f3
ba	aa
bb	b3
bc	ee
bd	f9
be	ef
bf	cd
c0	7b
c1	41
c2	42
c3	43
c4	44
c5	45
c6	46
c7	47
c8	48
c9	49
ca	2d
cb	93
cc	94
cd	95
ce	a2
cf	e4
d0	7d

Multinational EBCDIC to ASCII Data Translation Table (Continued)

EBCDIC	ASCII
d1	4a
d2	4b
d3	4c
d4	4d
d5	4e
d6	4f
d7	50
d8	51
d9	52
da	fb
db	96
dc	81
dd	97
de	a3
df	98
e0	5c
e1	20
e2	53
e3	54
e4	55
e5	56
e6	57
e7	58
e8	59
e9	5a
ea	fd
eb	e2
ec	99
ed	e3
ee	e0
ef	e5
f0	30
f1	31
f2	32
f3	33
f4	34
f5	35
f6	36
f7	37
f8	38
f9	39
fa	fc
fb	ea
fc	9a
fd	eb
fe	e9
ff	20

Appendix B: IBM EBCDIC To ISO ASCII Translation Table

The following chart documents the seven-bit ASCII hexadecimal codes which can be implemented in the LinkUp 5294 for the various character sets listed below.

EBCDIC CODE	4A	5A	6A	79	5B	7B	7C	5F	A1	C0	D0	E0	4F	7F
Austria Germany	Ä 5B	Û 5D	ð 7C	‘ 60	\$ 24	# 23	 40	^ 5E	ß 7E	ä 7B	ü 7D	Ö 5C	! 21	" 22
Belgium	[5B] 5D	ú 7C	‘ 60	\$ 24	# 23	à 40	^ 5E	ˆ 7E	é 7B	è 7D	ç 5C	! 21	" 22
Denmark Norway	# 23	· 24	ø 7C	‘ 60	Å 5D	Æ 5B	Ø 5C	^ 5E	ü 7E	œ 7B	å 7D	\ 40	! 21	" 22
Italy	• 5B	é 5D	ò 7C	ù 60	\$ 24	£ 23	 40	^ 5E	ˆ 7E	à 7B	è 7D	ç 5C	! 21	" 22
Portugal	[23] 21	ò 7D	‘ 60	\$ 24	À 5B	Ò 5D	^ 5E	ç 7C	à 7B	’ 40	Ç 5C	 7E	" 22
Spain	[5B] 5D	ñ 7C	‘ 60	£ 23	Ñ 5C	@ 40	¬ 5E	ˆ 7E	{ 7B	}	\ 24	 21	" 22
United Kingdom	\$ 24	! 21	 7C	‘ 60	£ 23	# 5D	@ 40	¬ 5E	ˆ 7E	{ 7B	}	\ 5C	 5B	" 22
United States	[5B	! 21] 5D	‘ 60	\$ 24	# 23	@ 40	^ 5E	ˆ 7E	{ 7B	}	\ 5C	/ 7C	" 22

Appendix C: Supported ASCII Devices

This appendix identifies the various ASCII terminals, PCs, word processors, and printers currently supported by the LinkUp 5294. The right-hand column shows the Terminal or Printer Module IDs that should work best with each device listed.

ASCII TERMINALS

Manufacturer	Terminal	Module ID
ADDS	Regent and Viewpoint Viewpoint 60	VEWP VP60
AMPEX	210/230 219	TV925 VT100
Anderson Jacobson	AJ-520	VT52 or VT100
ANSI Standard 3.64	Any ANSI Standard 3.64-compliant terminal	ANSI
Beehive	ATL 008	VT100
C.Itoh	101 7101 7103	VT100 C7101 C7103
Colorgraphic	MVI-100	VT100
Cybernex	XLB-5291	CY5291
Data General	Dasher D100/D200	D200
Datamedia	DT80/1,DT80/2 DT80/3 DT80/S Colorscan 10	VT100 TV925 VT100 VT100
DEC	VT-52 VT-100/VT-101 VT-102/VT-12S/VT-131/ VT-220/VT-240	VT52 or VT52X VT100 VT220
Direct	VP800C	VT100
Falco	TS-I Fame-100 Fame-U	VT52 VT100 ANSI
Hazeltine	Esprit Esprit III Esprit 10-51	ADM3A TV925 HZSI
Hewlett-Packard	HP-2621A/2645	HP45

APPENDIX C: Supported ASCII Devices

Manufacturer	Terminal	Module ID
IBM	3101	I3101
	3151	I3151
	3161/3163	I3161
	3164	I3 164
Informer	301/401	VT52 or I3101
KDE	802	VT52
Lear Siegler	ADM-3A	ADM3A
	ADM-S	ADM3P
	ADM-11	ADMI 1
	ADM-21/22/23/24	ADM21
	ADM-36	VT100
	ADM 12	ADM3P
Liberty Electronics	Freedom 100	TV925
MicroTerm	ACT-SA	ACTSA
	MIME-2A	VT52
	MIME-740/Ergo 4000	VT100
	Ergo 201	VT52 or TV925
	Ergo 301	VT52 or VT100
MVI	7	VT100
NCR	7901	VIEWP
Northern Telecom	Displayphone	DISPH
QUME	QVT-102	ADM3A
Radio Shack	DT-1	TV910
REBUS	3000	REBUS
Soroc	IQ120	IQ120
TAB	132	VT52
	13V15	VT100
TELERAY		VT52
TeleVideo	910	TV910
	910-/912	TV910P
	920/925/950	TV925
	970	TV970
	Personal Terminal	TV910
Telex	310	I3101
Tymshare	Scanset	SCANS

LINKUP 5294 WITH DL5294 FIRMWARE

Visual	100/300/400 110 50/200	VT100 D200 ADM3A or VT52
Wyse	WY-100 WY-30 WY-60 WY-60 w/extended keyboard	WY100 WY30 WY60 WY60X
Xpoint	Remote 91	HZ51
Zenith	Z-19 ZT-1	VT52 or VT100 VT52
Zentec	Zephyr	TV925

PERSONAL COMPUTERS AND WORD PROCESSORS

Computer	Recommended Software	Module ID
Apple IIe/IIc	Softterm Package	ADM3P
Apple III	Apple Access III	ADM3P
Apple Lisa	Included with Lisa	VT100
AT&T 6300	IBM PC Program	T5250
Columbia	IBM PC Program	T5250
COMMODORE 64	VIP Terminal Emulator	VT52
COMPAQ	IBM PC Program	T5250
CPT	CPT VT-52 Package	VT52
DEC Rainbow VT180	Comm. Package from DEC	VT100
Direct	Included in Computer	VT100
EXXON	EXXON TV925 package	TV925
Fortune	ITE package	TV925
HP-200 series	HP Terminal Emulator program	HP4S

Computer	Software Package	Module ID
IBM PC	IBM PC Program	T5250
IBM AT	IBM PC Program	T5250

APPENDIX C: Supported ASCII Devices

IBM PC Convertible	IBM PC Program	T5250
IBM PC Jr.	IBM PC Program	TS250
Kaypro	Superterm Paclcage	ADM3P
Leading Edge PC	IBM PC Program	T5250
Radio Shack Model-II	Radio Shack ADM3A Emulator	ADM3P
Sperry PC	IBM PC Program	T5250
TIProf. Comp.	Octacomm/PC	VT100
Toshiba 3100	IBM PC Program	T5250
Vector Graphic	Gulf Data ADM3A Package	ADM3P
Victor 9000	ASCOM Async Package	ADM3A
Xerox 820	ASCOM Async Paclcage	ADM3P
Xerox 820-II	Included with computer	ADM3P
Zenith Z-89/90/100	Zenith Terminal Package	VT52
Zenith Z-150	IBM PC Program	T5250

ASCII PRINTERS

Manufacturer	Model	Module ID
Centronics	351 a 359	CENTRN
C. Itoh	300 or 600	CI300
Dataproducts®	SPG8050	DP8050
General Electric®	GE 3000	GE3000
Genicom	3410 4410, 4440	GEN34 GEN44
EPSON®	RX/FX/MX/JX/80/100	EPSON
Hewlett Packard	LaserJet series	HPDPL HPDPP HPGEN
Okidata	MicroLine 82/83/84/92/93	OKIM84
Most Others	(Generic Support)	PRINT

Appendix D: System/36 Configuration Guide

NOTE

Before you change the configuration of the System/36, the LinkUp 5294 must be configured according to the instructions in Section 7.5.

After completing configuration of the LinkUp 5294, configure the System/36.

System configuration is a process that specifies the machines and devices within a particular data-processing system. The information you supply during the system-configuration process is stored in a library member called a “configuration member.”

After the configuration member has been cleared or changed, you need to load the configuration information within this member to the master configuration record. The load process must be completed before the system can use this information to recognize new or changed devices and communications lines. You can create a configuration member or change the information in an existing configuration member by using the CNFIGSSP procedure.

NOTE

If you have data security on your system, you must have update access to the library that contains the configuration member in order to change or delete a configuration member (Option 2 in the Main Menu). To change or rebuild the master configuration record (Options 12 and 13, in the Main Menu), you must have service aid authority. Options 12 and 13 are not displayed if you do not have service aid authority.

The following step-by-step instructions show you how to use the CNFIGSSP procedure to create or change a configuration member. The instructions also show you how to apply the configuration member to the master record.

This appendix describes the steps necessary for configuration of the communication line, control unit, and devices shown in Figure E-1. The configuration in Figure E-1 is only an example. The possible configuration combinations are too numerous to represent here.

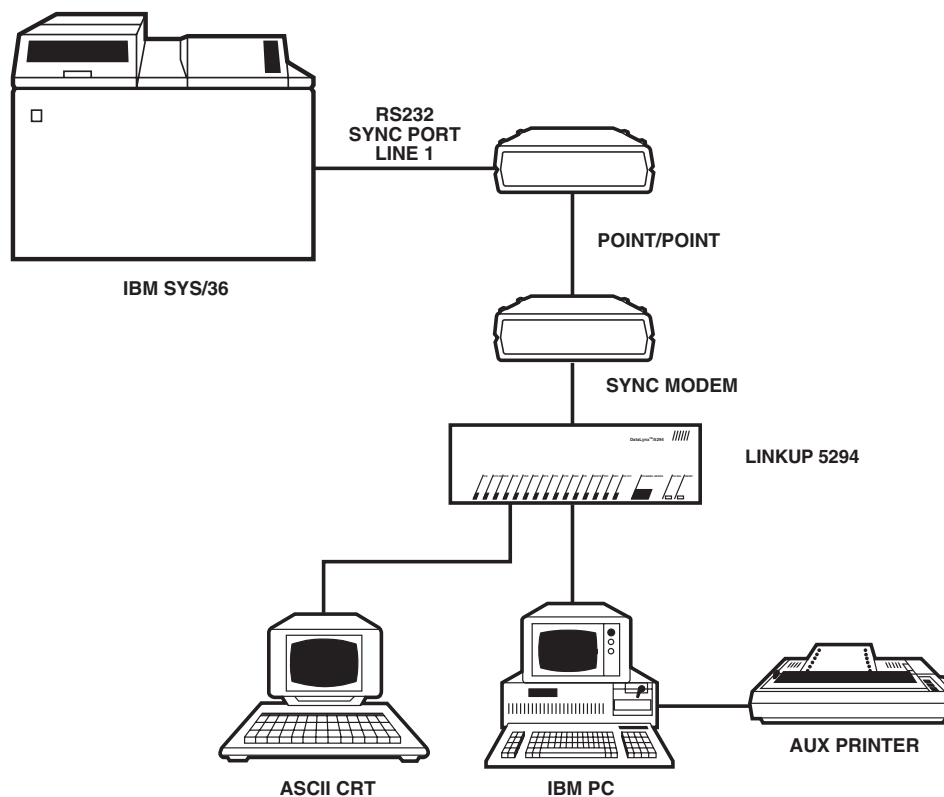

Figure E-1. Sample Configuration.

D.1 Communications Line

An overview of the displays shown by System/36 for line configuration is listed below. If you intend to connect the LinkUp 5294 to an existing communications line, go to **Section E.2**.

- STEP 1 — Run CNFIGSSP Procedure
- STEP 2 — 1.0 Main Menu Option 2
- STEP 3 — 3.0 Member Definition
- STEP 4 — 4.0 Member Definition New
- STEP 5 — 6.0 Member Description
- STEP 6 — 5.0 Member Menu Option 1
- STEP 7 — 27.0 Display/Printer Menu Option 2
- STEP 8 — 9.0 Remote Workstation <Enter>
- STEP 9 — 10.0 Remote Line Definition
- STEP 10 — 27.0 Display/Printer Menu
- STEP 11 — 1.0 Main Menu Option 14

STEP 1

In order to access the System/36 configuration main menu, enter the command procedure CNFIGSSP on the main System/36 help menu, shown below. The CNFIGSSP procedure command is requested rather than selecting an option on the Sys/36 Main Menu.

```
MAIN

Select one of the following:
  1. Display a user menu
  2. Perform general system activities
  3. Use and control printers, diskettes, or tape
  4. Work with files, libraries, or folders
  5. Use programming languages and utilities
  6. Communicate with another system or user
  7. Define the system and its users
  8. Use problem determination and service
  9. Use office products
 10. Sign off the system

Cmd3-Previous menu Cmd7-End Cmd-12-How to use help
Home-Sign on menu
Ready for option number of command
CNFIGSSP
```

STEP 2

Enter Option 2 at the CNFIGSSP Main Menu, shown below.

```
1.0 CNFIGSSP - MAIN MENU

Select one of the following:
  1.How to use CNFIGSSP
  2.Create, change, or delete a configuration number
  3.Review a configuration
  4.Print a configuration

 10.Configuration report side

 12.Apply change to the master configuration record
 13.Rebuild the master configuration record (update
    to next release)
 14. End CNFIGSSP

Option: 2

Cmd3-Previous menu

Help text is available throughout the CNFIGSSP
Procedure by pressing the help key
```

STEP 3

To change an existing configuration member, select Option 1 at Menu 3.0, shown at the top of the next column. If a configuration member does not exist, select Option 2 (Create, change, or delete a configuration member).

Option A: Type the name of the configuration member to contain the line configuration, or use the member name already displayed, which is the name of the last configuration member applied to the master configuration record.

Option B: Type the name of the library where the configuration member is stored. The example at the top of the next column uses #CNFGLIB as the configuration library. The #CNFGLIB is a system library, denoted by the # preceding the library name. It is suggested you use this library for all configuration members on the System/36 in order to maintain consistency and accountability.

3.0 CONFIGURATION MEMBER DEFINITION

Select one of the following:

- 1.How to use CNFIGSSP
- 2.Create, change, or delete a configuration member
- 3.Review a configuration

Option	1
Member name	SYSCNFIG
Library Name	#CNGBLIB

Cmd3-Previous menu

STEP 4

To change an existing configuration member (Option 1 in Step 3) go to Step 5. If you create a new configuration member because one does not currently exist (Option 2 in Step 3) menu 4.0 will be shown (see below). Select Option 2 (the configuration is in the master configuration record). This option makes an exact duplicate of the master configuration record for modification.

NOTE

Do not select Option 1 (Standard System/36 configuration (with base default values)). This option is used only when you are creating a configuration member that you want to use for a different system.

4.0 CONFIGURATION MEMBER DEFINITION - NEW

The new configuration member is based on:

1. Standard System/36 configuration (with base default values)
- 2.The configuration in the master configuration record
- 3.Previously created configuration member

Option	2
--------	---

STEP 5

The following display describes information that was used as a basis for the new member (Option 2 from Step 4), or the configuration member you specified (Option 1 from Step 4).

Make any changes to the the description of the configuration member and press <Enter>.

6.0 CONFIGURATION MEMBER DESCRIPTION

1. Describe the configuration member (up to 60 characters)
2. Specify main storage size in K-bytes.....0128-1024 0256
3. Specify disk storage size in M-bytes.....030-800 200

Cmd3-previous menu

STEP 6

The intention is to change only the configuration of devices attached to the System/36; therefore, select Option 1 (Work with display stations and printers) on Menu 5.0.

5.0 CONFIGURATION MEMBER MENU

Select one of the following

1. Work with display stations and printers
2. Add or delete program products, optional SSP, and SSP features
3. Define base SSP values
4. Specify sizes for disk VTOC, history file, and task work area

If no more changes are to be made to your configuration member, select the following option:

5. Save configuration member and return to main menu for CNFIGSSP

Option: 1

Cmd3 - previous menu

Cmd19-Cancel

STEP 7

Select Option 2 in Menu 27.0 to add a remote line characteristic.

27.0 CONFIGURATION - DISPLAY STATION AND PRINTER MENU

Select one of the following:

1. Add or delete local display stations and printers
2. Add or delete remote line characteristics
3. Add or delete remote controllers, display stations, printers
4. Assign default printers to display stations
5. Assign display station control (subconsoles for printers)
6. Change display station or printer work station IDs
7. Change display station or printer characteristics
8. Select the system printer
9. Add remote service device definition
10. Delete remote service definition
11. Return to previous menu

Option 2:

Cmd3-Previous menu

Cmd19-Cancel

STEP 8

The following provides for X.25 line configuration. The System/36 feature allows the System/36 to connect to an X.25 network. For more information on X.25 configuration procedures, see *Using System/36 Communications*, IBM publication number SC21-9082. To continue to the next screen, press <Enter>.

9.0 CNFIGSSP - REMOTE WORKSTATION

1.For a system with X.25 specify an X.25 configuration member.....

Cmd3-Previous menu

Cmd 19-Cancel

STEP 9

Display 10.0 (CNFIGSSP - Communications Line Definition For Remote Work Stations) allows selection of communications lines for additions, changes, or deletions. In this example, we will be adding communication line 2 to the System/36. The System/36 allows a maximum of eight communications lines.

Prompt 1: Enter the line number you want to add or change.

Prompt 2: Specify whether the line being defined is to be used in an X.25 network.

NOTE

Prompt 2 will be displayed only if you have specified an X.25 configuration member in Step 8.

Prompt 3: If the line is nonswitched, specify 1. If the line is switched, specify one of the following switch types:

- 2 Switched manual call. The System/36 operator must place the call to the remote system to establish the communications connection.
- 3 Switched auto answer. The System/36 will automatically answer an incoming call to establish the connection.
- 4 Switched manual answer. The System/36 operator must answer an incoming call and place the modem in data mode to establish the communications connection.

NOTE

If you answer YES to prompt 2 for an X.25 network, then you must specify either 1 (nonswitched) or 3 (switched auto answer). No manual types are allowed in an X.25 network.

Prompt 4: Automatic reconnect provides recovery on a switched or nonswitched line for remote workstation controllers that are signed on to the System/36. If automatic reconnect is specified for a switched line, the system will automatically try to reestablish its connection with the remote controller. If automatic reconnect is specified for a nonswitched line, and a line error or station error occurs, the system will periodically try to reestablish communications with the control unit.

10.0 CNFIGSSP - COMMUNICATIONS LINE DEFINITION FOR REMOTE WORKSTATIONS

The following lines have been defined 1
1. Which line is being defined? 1-8 2
2. Is line to be used in an X.25 network? Y-N N
3. What type of line is it 1
1 - Non switched 3 - Switched autoanswer
2 - Switched manual call 4 - Switched manual answer
4. Automatic reconnect for the line N

Cmd3 - Previous menu Cmd9-Drop line Cmd19-Cancel

STEP 10

After answering all prompts for the communications line, press <Enter> to return to Display 27 (see display in Step 7).

D.2 Remote Controller, Display Stations, and Printers

The list below gives an overview of the displays shown for configuring the remote controller, display stations, and printers. Notice that Step 6, Display 27.0, is the display you were left at after configuration of communications line 2. We can begin our configuration of the remote devices on Display 27.0 rather than returning to the Main Menu in Step 1.

- STEP 1 — Run CNFIGSSP Procedure
- STEP 2 — 1.0 Main Menu Option 2
- STEP 3 — 3.0 Member Definition
- STEP 4 — 6.0 Member Description
- STEP 5 — 5.0 Member Menu Option 1
- STEP 6 — 27.0 Workstation Menu Option 3
- STEP 7 — 13.0 Remote Controller
- STEP 8 — 14.0 Remote Cluster Definition
- STEP 9 — 12.0 Workstation Definition
- STEP 10 — 27.0 Workstation Menu Option 6
- STEP 11 — 40.0 Workstation Assignment
- STEP 12 — 27.0 Workstation Menu Option 11
- STEP 13 — 5.0 Member Menu Option 5
- STEP 14 — 1.0 CNFIGSSP Main Menu
- STEP 15 — 3.0 Configuration Member Definition
- STEP 16 — 7.0 Change Master Configuration Option 3

NOTE

Before configuring the remote controller, display stations, and printers you must configure the communications line (see D.1).

STEP 6

Select Option 3 on Display 27.0.

STEP 7 Remote Controller Definition

The remote controller is a device that is accessed by the System/36 through the communications line. It controls the operation of one or more remote display stations and printers. The LinkUp 5294 emulates IBM 5251 Model 12 and 5294 cluster controllers and is classified as a remote controller.

If you have previously defined workstation controllers, Display 13.0 will show the word EDIT at the top of the display. If you are adding a new remote workstation controller, the word ADD must be at the top of the display. Press Command Key 5 to enable you to define a new remote controller.

Prompt 1 (Remote controller ID): You may specify any ID of your choice, provided it has not been used previously. In this example we will use C02.

Prompt 2 (Describe the remote controller): This 40-character field can be used to help identify controller information, such as the location of the controller.

Prompt 3 (Controller type): You must specify the model of the unit which controls your remote work stations. Since the LinkUp 5294 emulates an IBM 5251 model 12 controller in this example, enter 1 for this controller model type.

Prompt 4 (Controller station address): The controller station address is used to identify the controller to the System/36. The controller unit station address must match the address given internally to the LinkUp 5294 for the control unit number (this is further described in **Section 7.5** of this manual). Each control unit on the System/36 must have a unique address. In this example, enter 02.

Prompt 5 (Communication line): This is the remote line number the LinkUp 5294 is attached to. For this example, enter a 2.

NOTE

This line must have been previously defined in this configuration member.

Prompt 6 (For a switched line, optionally specify 1-3 alternative lines): If the line number you specified in Prompt 5 is a switched line, you can specify alternative lines to which the LinkUp 5294 can be attached. The alternative lines you specify must also be switched lines with the same switch type. For example, if Line 2 has a switch type of manual answer and Line 3 is selected as an alternative line, then Line 3 must have a switch type of manual answer. You can specify up to 3 alternative lines. If you have only one line or if you specified a non-switched line at prompt 5, have this field blank. In this example Line 2 entered in Prompt 5 is a non-switched line, therefore, the field for prompt 6 is left blank.

13.0 CNFIGSSP - REMOTE CONTROLLER DEFINITION

1. Remote Controller ID C02

2. Describe the remote controller
LinkUp 5294 Remote Controller

3. Controller type 1

1. 5251 model 12 2. 5294

4. Controller station address 01-FD 02

5. Communications line 1-8 2

6. For a switched line, optionally specify
1 to 3 alternative lines

Cmd2-Scan Cmd3-Previous menu Cmd5-Add Controller
Cmd6-Restart Cmd9-Delete remote controller

STEP 8

Display 14.0 (CNFIGSSP - Remote Cluster Definition) is shown below. Use this display to add display stations and printers to a new remote controller (the LinkUp 5294). Enter the number of devices attached to each port of the LinkUp 5294. Configure the ports according to a dual -cluster feature. The LinkUp 5294 can accommodate up to 8 different units (one to each cluster port or any combination of display units and auxiliary printers per port up to 8 devices). For our example, one device is added for Ports 1, 2, and 3.

NOTE

You must have one device on the previous port before using another port on the same cluster. For example, you cannot specify a device on Port 3 if one is not specified on Port 2.

14.0 CNFIGSSP-REMOTE CLUSTER DEFINITION

Specify up to four display stations or printers attached to each cluster feature below:

SINGLE CLUSTER FEATURE

Port number 1 2 3 4

Number of display stations and printers 1 1 1 0

DUAL CLUSTER FEATURE

Port number 5 6 7 8

Number of display stations and printers 0 0 0 0

Cmd 19 - Cancel

STEP 9

Display 12.0 (CNFIGSSP - Workstation Definition), shown below, allows you to specify the arrangement of the display stations and printers on the LinkUp 5294. Notice that in the example all devices are configured on address 0, ports 1-3. The remote controller (device code 02) is always displayed at address 0 on port 0. Each device has a two-character code or ID that identifies it by function (display station or printer) and by type. A list of device codes is shown after the display. You can also press Command Key 5 for a display of all valid device codes.

When all changes have been made to Display 12.0, press Command Key 3 to return to Display 27.0.

12.0 CNFIGSSP-WORKSTATION DEFINITION

Specify the arrangement of your display stations and printers.
Printers correspond to the work station address:

Displays: 00. Single color display station.

0 1 2 3 4 5 6 7

02		0 — P
01		1 — 0
PB		2 — R
01		3 — T
		4 — S
		5 —
		6 —
		7 —
		8 —

Displays:

- Code 00 — Single Color Display Station
- Code 01 — 5251 Model 11
- Code 02 — 5251 Model 12
- Code 10 — 5291
- Code 11 — 3180
- Code 20 — Multiple color display station
- Code 21 — 5294 Model 1
- Code 22 — 5294 Model 2

Printers:

- Code PA — 3262 Printer
- Code PB — 5256 Printer
- Code AA — 5256 Model 1
- Code AB — 5256 Model 2
- Code AC — 5256 Model 3
- Code PC — 5224 or 5225 Printer
- Code BA — 5224 Model 1
- Code BB — 5224 Model 2
- Code CA — 5225 Model 1
- Code CB — 5225 Model 2
- Code CC — 5225 Model 3

LINKUP 5294 WITH DL5294 FIRMWARE

Code CD — 5225 Model 4
Code PD — 5219 Printer
Code DA — 5219 Model D01
Code DB — 5219 Model D02

When you defined the display stations and printer, default values were assigned for certain characteristics of each device (see the list below). Before a printer can print any output, it must be assigned to a display station. The System/36 allows you to define printer assignments through the CNFIGSSP process.

Display Station	Default Value
Default Printer	ID System printer
Display Type	C (command)
Stripe reader	No
Print Key heading lines	No
Automatic Vary on	
Local display stations	Yes
Remote display stations	No
Plotter Type	None
Plotter address	
IGC keyboard	No

STEP 10

From Display 27.0, enter Option 6.

STEP 11

Display 40.0 (CNFIGSSP - Work Station ID Assignments).

The first display will show the 3262 System Printer, if you have one. If you do not have a 3262 Printer, the first display will show the system console. By pressing <Enter>, you can display each controller and attached display stations and printers. Press <Enter> until the LinkUp 5294 cluster controller added in Part B appears. Following the LinkUp 5294 will be the attached devices for each port. In this example, assign the printer ID P1 to device 01 on port 1. Press <Enter> until the next display station on Port 0 appears and assign the same printer. You have now assigned the remote printer to both workstations (ports 1 and 3). Pressing <Enter> will store the assignment changes and display the next port.

40.0 CNFIG - WORKSTATION ID ASSIGNMENTS

Change the workstation ID, assigned printer, or subconsole assignment.

Port number	1
Work station address	0 1 2 3 4 5 6
Device code	01

1. Workstation ID	W2
2. Assigned printer ID	P1
3. Subconsole ID	W1

Cmd3 Previous menu	Cmd 19-Cancel
--------------------	---------------

If you have no more changes to make regarding your display stations and printers, press Command Key 3 to return to Display 27.0.

STEP 12

Display 27.0. Enter Option 11.

STEP 13

Display 5.0 (Configuration Member Menu) is shown below. If you have no more changes, enter Option 5 to save the configuration member and return to Display 1.0.

SETCOMM Procedure

It may be necessary to change certain characteristics of the communications line before loading the communications configuration member. You can use the SETCOMM procedure to change certain items. To use SETCOMM, go to the main help menu of Step 1. Enter SETCOMM at the Ready for option number or command prompt, and the available parameters will be displayed. If changes are made, you must reboot the system before these changes become effective. Each parameter is optional; if not specified, the preset system values remain unchanged.

5.0 CONFIGURATION MEMBER MENU

Select one of the following:

1. Work with display stations and printers
2. Add or delete program products, optional SSP, and SSP features
3. Define base SSP values
4. Specify sizes for disk VTOC, history file, and task work area

If no more changes are to be made to your configuration member, select the following option:

5. Save configuration member and return to main menu for CNFIGSSP

Option: 5

D.3 Changing the Master Configuration Record

STEP 14

NOTE

Changing the Master Configuration Record requires a dedicated system. No other programs can be running on the system. Use the STATUS command to check for any system activity. Use the STOP WORKSTN command at the system console to ensure that any operators currently signed on to the system cannot start jobs or put jobs on the job queue. Make sure all local and remote devices are off-line (signed off).

At Display 1.0 (CONFIGSSP - Main Menu), enter Option 12 (Apply change to the master configuration record). See below.

1.0 CONFIGSSP - MAIN MENU

Select one of the following:

- 1.How to use CNFIGSSP
- 2.Create, change, or delete a configuration member
- 3.Review a configuration
- 4.Print a configuration
- 10.Configuration report aids
- 12.Apply change to the master configuration record
- 13.Rebuild the master configuration record (update to next release)
14. End CONFIGSSP

Option: 12

Cmd3-Previous menu

Help text is available throughout the CONFIGSSP Procedure by pressing the help key

STEP 15

Display 3.0.

Prompt 1: Enter the configuration member added in Section A (SYSCNFIG).

Prompt 2: Enter the library name where the configuration member is stored (#CNFGLIB).

Press <Enter>.

3.0 CONFIGURATION MEMBER DEFINITION

Member name	SYSCNFIG
Library name	#CNFGLIB

STEP 16

WARNING

Be sure to select Option 3 for displays and printer. Any other option could crash the system.

Display 7.0

Select Option 3. This option allows you to update only the display station and printer portion of the master configuration record.

After all changes have been copied to the Master Configuration Record, you will be asked if you want a printout of this configuration. Specify YES. After the configuration has been printed, press <Enter>. The system will automatically perform an IPL, and the new line with remote devices will be recognized by the System/36.

Verify that the devices you configured are optional. Make sure display stations are powered on and that there is a sign-on display.

Make sure your printers are turned on and ready to print. Press the print key at that display station. Observe which printer id printing. The printer assigned to that particular display should print.

If you have problems, compare a configuration printout with what should be defined. Verify that the communication line is defined properly. If not, use the SETCOMM procedure described in Step 13.

If there are any problems associated with the CNFIGSSP procedure, consult your IBM System/36 Operations Manual.

Appendix E: System/38 Configuration Guide

System configuration is a process that specifies the machines and devices within a particular data processing system (see Figure E-1). The Control Program Facility (CPF) is the System/38 system support program which, in addition to providing work management and batch job functions, coordinates all interactive processing.

Interactive processing on the System/38 takes place within the subsystem QINTER or a user-created subsystem. QINTER (an environment supplied by IBM) supports interactive processing through all the workstations attached to the system. All workstation devices, excluding the system console, are attached to this subsystem. If you want the new configurations to be in effect as soon as possible, you have two choices:

1. You may terminate the QINTER subsystem by using the TRMSBS command, and vary offline the appropriate control unit (VRYCTLU command and any attached devices (if they previously exist). Reverse this procedure after completing the new configuration.
2. You may power down the system using the PWRDWN SYS command, then power on the system, setting switch 1 to 4 (IPL ABBR) and switch 2 to 0 (NORMAL) on the operator/ service panel, and pressing the power-on switch. After signing on with the SECURITY OFFICER password, request the configuration menu from the start control program facility prompt 2. When you are finished configuring devices, press the CFI KEY to exit from the configuration menu.

With either of the choices (1 or 2) all interactive processing within the subsystem (exclusive of the system console) must be terminated for the configuration process.

To avoid the necessity of shutting off the system, we will use Choice 1.

NOTE

You may change the configuration of the System/38 before or after configuration of the LinkUp 5294. Refer to the instructions in Section 7.5 of this manual for the configuration requirements of the LinkUp 5294.

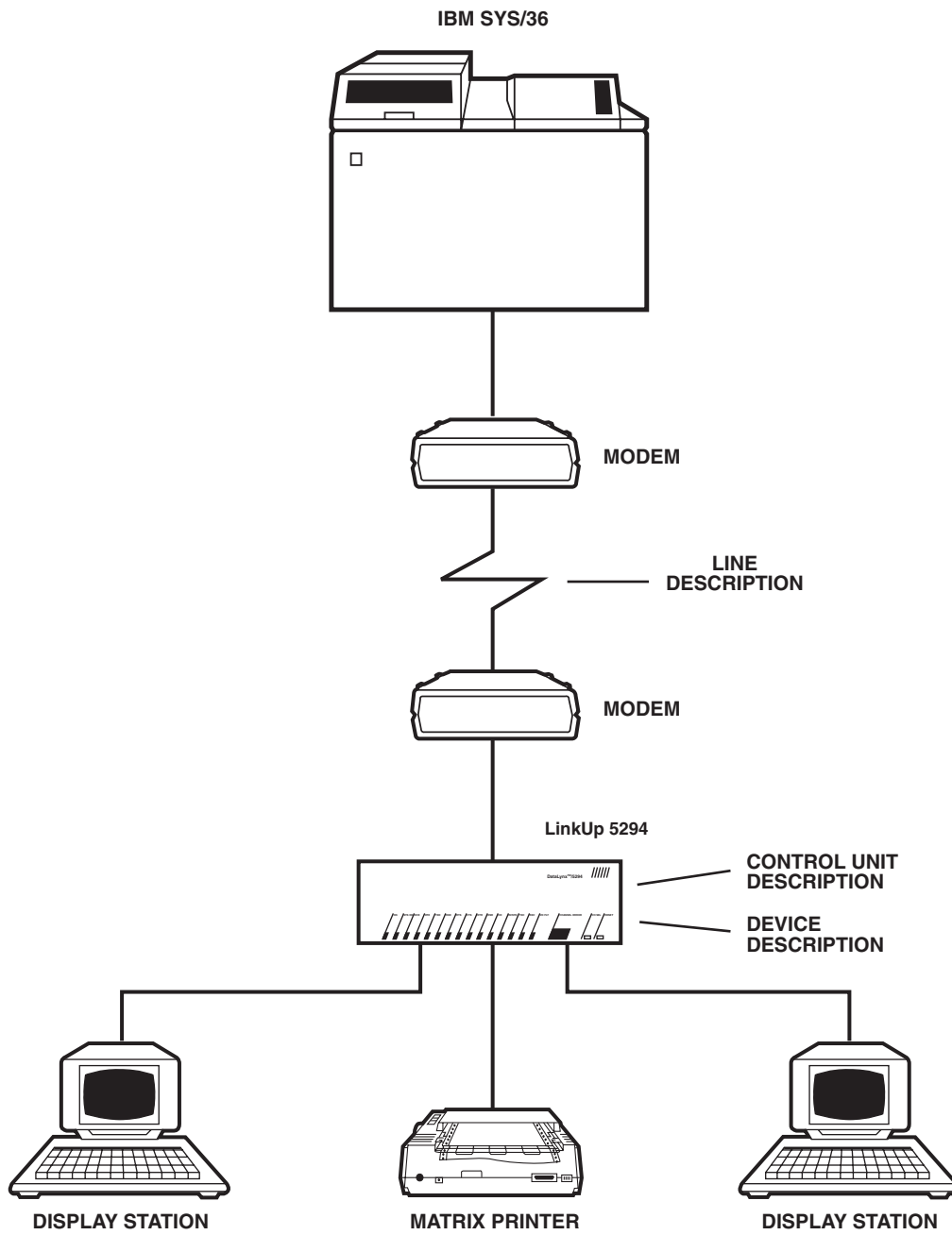

Figure E-1. Sample Data-Processing System.

Figure E-1 shows the Remote Configuration Setup, consisting of one point-to-point/leased line, two display stations, and a matrix printer. The LinkUp 5294 emulates IBM Model 12 and/or IBM 5294 Cluster Controllers.

Signing on to the System/38 console with the Security Officer Password displays the command-entry screen. The command-entry screen allows entry of System/38 Control Language commands to perform functions of the system's Control Program Facility (CPF).

A sample Remote Workstation configuration is listed below:

1. Terminate Subsystem (QINTER)
2. Create Line Description
3. Create Control Unit Description
4. Create Device Description
5. Add Work Station Entries For Subsystem
6. Vary Communication Line On
7. Vary Control Unit On Line
8. Vary Devices On Line
9. Start Subsystem (QINTER)

STEP 1. Terminate Subsystem QINTER

Prior to terminating the subsystem QINTER, check that all workstations are signed off. Enter the terminate subsystem command TRMSBS. Press the Command 4 key. Pressing this provides a prompt screen for entering parameters for the TRMSBS command. The command example below cancels all interactive jobs in the QINTER subsystem and terminates the subsystem.

```
::TRMSBS SBS (QINTER) OPTION(*CNTRLD) DELAY(60)
```

NOTE

In this example, we are using the subsystem QINTER, an interactive subsystem supplied by IBM. Verify that this is the appropriate subsystem for creating or modifying your system devices. Do not assume that QINTER is the only interactive subsystem. To determine if other interactive subsystems exist, enter DSPSBS SBS(*ALL).

STEP 2. Create Line Description

Entering the Create Line Description Command CRTLIND (see below) creates a line description for the specified communications line. The line command describes line features to the system; this includes the description of the modem (and its features) connected to the line. In Figure E-1, the remote line consists of a point-to-point/leased line with non-IBM modems attached. This line is configured as a Primary Synchronous Data Link Control (SDLC) at 9600 baud rate with a 4-wire connection.

Many of the prompts in this example are not included in the command example below. If a value is not included in the command statement the default value is assumed by the system. Before using this command, you should refer to the IBM Guide To Product Installation and Device Configuration and the IBM System/38 Control Language Reference Manual for considerations relating to communications lines interfaces and to modem characteristics, types, and features.

```
::CTRLIND LIND (LINKUP1) LINNBR (20) TYPE (*SDLC) CNN(*PP)+  
RATE (9600) SELECT(*NO) NONRTZN(*YES) CLOCK (*NO) WIRE(4)+  
OEMMDM(*YES) TEXT (POINT TO POINT LINKUP INE 1')
```

NOTE

This command should be used to create a line description before the associated Control Unit Descriptions and device descriptions are created for the control unit and devices attached to the line. If the descriptions are created out of sequence, any commands referring to names of descriptions not yet created are rejected by the system.

STEP 3. Create Control Unit Description

The Create Control Unit Command (CRTCUD) identifies the LinkUp 5294 control unit to the System/38 (see below). This command should be used to create the control-unit description only after the associated line description has been created for the line attached to the LinkUp 5294. The attached device descriptions should not be created until after the line description and the LinkUp control unit description are created.

“5251” is entered for the Control Unit Type parameter (TYPE). The Control Unit Description (CUD) specifies the name of the Control Unit Description that is being created. This name should be unique to all existing control units. The LinkUp 5294 emulates the IBM 5251 Model 12 and IBM 5294 cluster controllers. In this example, “12” should be entered for the (MODEL) parameter. Refer to the explanations in the IBM Control Language Reference Manual for entering a value for the Control Unit Address (CTLADR) parameter and the remaining parameters for the CRTCUD command.

```
::CRTWD CUD(DL51CU) TYPE(5251 MODEL (12) CTLADR(0120) +
```

```
LINE(LINKUPLI) EXCHID(02000001) TEXT('POINT TO POINT+ LINKUP CONTROL UNIT')
```

NOTE

Do not enter the device names in the CRTCUD command. When you create the device descriptions later on (in Step 4) and reference the LinkUp 5294 control unit through the (CTLU) parameter, those devices are automatically included in the (DEV) parameter for the associated control -unit description.

STEP 4. Create Device Description

The Create Device Description command CRTDEVD creates a device description for the specified devices which describes all of the features for a particular device to the System/38. This command should be used to create each device description only after the associated line description and control description are created.

The (DEV) parameter specifies the name of the device description that is being created. The name of an existing device description cannot be used. See the explanations in the IBM Control Language Reference Manual for entering values for the Device Address DEVADR values and the remaining parameters for the CRTDEVD command. In the remote setup example, both display stations emulate the IBM 5251 display station. Enter 5251 for the device type (TYPE) parameter.

The PRINTER parameter specifies the name of the 5224/5225/5256 printer to be associated with the display device. The device description of the workstation printer named in this parameter must have been previously created in another CRTDEVD command.

The printer in the remote setup emulates an IBM 5256 printer.

NOTE

If you plan to have print output sent by specific workstations to a specific remote printer, you must use the Create Print File CRTPF command. Enter the printer device description in the DEV parameter and the particular OUTQ for spooling. Make sure the Print File exists prior to including it in the PRTFILE parameter for creating the printer description.

CRTDEVD Command — Example 1:

```
::CRTDEVD DEVD (LINK2S1) DEVADR(000120) DEVTYPE (5251) + MODEL (11) CTLU(DL51CU)
ONLINE(*YES) DROP (*NO) WSCADR(*NONE) + TEXT('LINKUP TERMINAL A1')
```

```
::CRTDEVD DEVD(LINKWS2) DEVADR(020120) DEVTYPE(5251) + MODEL(11) CTLU(DL51CU)
ONLINE(*YES) DROP(*NO) PRINTER + (LINKP1)WSCADR(*NONE) TEXT(;'LINKUP TERMINAL
A2')
```

CRTDEVD Command — Example 2

```
::CRTDEVD DEVD(LINKP1) DEVADR(030120) DEVTYPE(5256) + MODEL(0002) CTLU(DL51CU)
ONLINE(*YES) DROP(*NO) WSCADR(*NONE) + TEXT('LINKUP PRINTER P1')
```

STEP 5. Add Workstation Entries for Subsystem

After the appropriate device descriptions are generated, the workstations must be assigned to a particular subsystem. Workstation job entries are added to the specified subsystem description through the ADDWSE command. Each entry describes one or more workstations that are to be controlled by the system. The workstations identified in the workstation entries are allowed to sign on to or enter the subsystem and execute jobs.

If every workstation of a particular type is to be included in a particular subsystem, only that workstation type should be entered in the WRKSTNTYPE command parameter. When you enter a workstation type, such as 5251, as opposed to a specific workstation description (which would be entered for the WRKSTN parameter), the system assigns all workstations of that type to the same interactive subsystem and not on an individual basis. The WRKSTN parameter specifies to the subsystem which device description will be included (by the DEVTYPE parameter of the CRTDEVD command).

NOTE

A value must be specified for either the WRKSTN or the WRKSTNTYPE parameter, but not both.

```
::ADDWSE SBS(DQINTER) WRKSTNTYPE(5251) JOB(*SBS) + MAXACT(*NOMAX)
AT(*SIGNON)
```

STEP 6. Vary Communication Line ON

Before the control unit and its attached devices can be varied active, the communication line to which they will be attached must be varied on. The VRYLIN command varies the specified line active or inactive depending on the STATUS Parameter.

```
::VRYLIN LINE(LINKUPL1) STATUS(*ON)
```

STEP 7. Vary Control Unit ON

The Vary Control Unit VRYCTLU command is used to vary one or more control units online or offline with the system. This command should be executed after the communications line it is attached to has first been varied online.

```
::VRYCTLU CTLU(DL51CU) STATUS(*ON)
```

STEP 8. Vary Devices Online

The Vary Device VRYDEV command is used to vary one or more devices online or offline with the system. A device cannot be varied online if:

- Its power is turned off
- The control unit to which it is attached is varied off line

NOTE

Although the VRYDEV command can be executed before a switched connection is made, the device is not actually online until the connection is made.

```
::VRYDEV DEV(LINKWS1) STATUS(*ON)
VRYDEV DEV(LINKWS2) STATUS(*ON)
VRYDEV DEV(LINKPI) STATUS(*ON)
```

STEP 9. Start Interactive Subsystem

The Start Subsystem STRSBS command starts a subsystem based on the subsystem description specified in the command. When the subsystem is started, CPF allocates the available workstations that were specified in the subsystem description. Each workstation whose name (or type, if not specified by name) is contained in one of the subsystem descriptions workstation entries, and whose entry specifies AT(*SIGNON), is allocated to this subsystem unless it is currently signed on to another subsystem. The sign-on prompt is displayed on each workstation that is allocated to an available workstation address.

```
::STRSBS SBS(QINTER)
```

Problem Determination

Verify that the devices you configured are operational. Make sure that display stations are powered on and that there is a sign-on display.

Make sure your printers are turned on and ready to print. Press the print key at that display station. Observe which printer is printing. The printer assigned to that particular display should print.

If you have problems, compare a configuration printout with what should be defined. Verify that the communication line is defined properly. Make sure the synchronous port cable is positioned properly (DCE or DTE, whichever is applicable) on the LinkUp 5294.

If there are any problems associated with the configuration procedure, consult your *IBM System/38 Guide to Program Product Installation and Device Configuration*, GC21-7775, or the *IBM System/38 Control Language Reference Manual*, SC21-7731.

Appendix F: Terminal Modules and ASCII Terminal Setups

This appendix identifies the Emulation Mode key sequences designed for each of the Terminal Modules currently supported in the LinkUp 5294. You will also find information on recommended switch or configuration setups for some of the specific ASCII Terminal types which the modules have been designed after.

The following chart lists each of the Terminal Modules, the ASCII terminal manufacturers and models (if appropriate), and where to find them in this appendix.

Module ID	Manufacturer	Model	Section
ACT5A	Microcom	ACT-5A Terminal	F.1
ADM11	Lear Siegler	ADM-11 Terminal	F.2
ADM21	Lear Siegler	ADM-21 Terminal	F.3
ADM3A	Lear Siegler	ADM-3A Terminal	F.4
ADM3P ¹		ADM-3A Terminal	F.5
ANSI	ANSI Standard	3.64 Terminal Type	F.6
COMPU ²			F.7
C7101	C. Itoh	CIE 7101 Terminal	F.8
C7103	C. Itoh	CIE 7103 Terminal	F.9
CY5291	Cybernex	XLB-5291	F.10
DISPH	Northern Telecom	Displayphone Terminal	F.11
D200	Data General	DASHER 200 Terminal	F.12
HP45	Hewlett Packard	HP-2645 Terminal	F.13
HZ51	Hazeltine	10/51 Terminal	F.14
IQ120	Soroq	IQ-120 Terminal	F.15
I3101	IBM	3101 Terminal	F.16
I3151	IBM	3151 Terminal	F.17
I3161	IBM	316V3163 Terminals	F.18
I3164	IBM	3164 Terminal	F.19
REBUS	REBUS	3000 Terminal	F.20
SCANS	Tymshare	Scanset Terminal	F.21
TV910	Televideo	910 Terminal	F.22
TV910P	Televideo	910 Plus/912 Terminals	F.23
TV925	Televideo	920/925/950 Terminals	F.24
TV970	Televideo	TV-970 Terminal	F.25

¹Especially designed Terminal Module for software packages emulating the identified terminal type.

²Especially designed Terminal Module for computer-to-computer applications.

³IBM or true compatible.

Module ID	Manufacturer	Model	Section
VIEWP	ADDS	Viewpoint/ Regent Terminals	F.26
VP60	ADDS	Viewpoint 60 Terminal	F.27
VT52	DEC	VT52 Terminal	F.28
VT52X ¹	DEC	VT52 Terminal	F.29
VT100	DEC	VT100 Terminal	F.30
VT220	DEC	VT220 Terminal	F.31
WY30	Wyse	WY-30 Terminal	F.32
WY60	Wyse	WY-60 Terminal	F.33
WY60X	Wyse	WY-60 w/extended keyboard	F.34
WY100	Wyse	WY-100 Terminal	F.35
XT100 ⁴			F.36

¹Especially designed Terminal Module for software packages emulating the identified terminal type.

³IBM or true compatible.

⁴Specially designed Terminal Module, based on VT100, for use with the IBM PC.

F.1 ACT5A Terminal Module - Microcom ACT-5A

The following list identifies the key sequences defined for the ACTSA Terminal Module.

1. Press <CTRL> concurrently with the indicated alpha key.
2. Press <ESC> prior to pressing the indicated alpha key.
3. The last position of the screen (row 24, column 80) is designed not to display a character. This prevents automatic scrolling.

5250 Function	Key Sequence	Hex Value Generated
<i>Cursor Movement</i>		
Character Backspace	(left arrow) BACKSPACE	03H
Cursor Up	up arrow	1AH
Cursor Down	down arrow	0BH
Cursor Left	left arrow	08H
Cursor Right	right arrow	18H
Field Advance	TAB	09H
Field Backspace	CTRL/B	02H
New Line	LINE FEED	0EH
Fast Left	N.A.	N.A.
Fast Right	N.A.	N.A.

LINKUP 5294 WITH DL5294 FIRMWARE

5250 Function	Key Sequence	Hex Value Generated
<i>Special Control</i>		
Error Reset	CTRL/R	12H
Insert Mode	CTRL/U	15H
Delete	DEL	7FH
Erase Input	CTRL/E	05H
Home	CTRL/^	1EH
<i>Field Exit</i>		
Duplicate	CTRL/D	04H
Field Minus	CTRL/F	06H
Field Plus	N.A.	N.A.
Field Exit	CTRL/T	14H
<i>Aid Generating</i>		
Enter	RETURN	0DH
Clear	PAGE ERASE	0CH
Help	ESC H	1BH 48H
Print	CTRL/P	10H
Roll Up	ESC U	1BH 55H
Roll Down	ESC D	1BH 44H
CMD 1	ESC 1	1BH 31H
CMD 2	ESC 2	1BH 32H
CMD 3	ESC 3	1BH 33H
CMD 4	ESC 4	1BH 34H
CMD 5	ESC 5	1BH 35H
CMD 6	ESC 6	1BH 36H
CMD 7	ESC 7	1BH 37H
CMD 8	ESC 8	1BH 38H
CMD 9	ESC 9	1BH 39H
CMD 10	ESC 0	1BH 30H
CMD 11	ESC -	1BH 2DH
CMD 12	ESC =	1BH 3DH
CMD 13	ESC !	1BH 21H
CMD 14	ESC @	1BH 40H
CMD 15	ESC #	1BH 23H
CMD 16	ESC \$	1BH 24H
CMD 17	ESC %	1BH 25H
CMD 18	ESC ^	1BH 5EH
CMD 19	ESC &	1BH 26H
CMD 20	ESC *	1BH 2AH
CMD 21	ESC (1BH 28H
CMD 22	ESC)	1BH 29H
CMD 23	ESC _	1BH 5FH
CMD 24	ESC +	1BH 2BH
<i>Special Host</i>		
System Request	ESC S	1BH 53H

5250 Function	Key Sequence	Hex Value Generated
<i>Signal:</i>		
Attn	ESC A	1BH 41H
<i>Extended Function:</i>		
Local Copy Print Req.	ESC P	1BH 50H
Local Copy Form Feed	ESC F	1BH 46H
Cancel Print	ESC C	1BH 43H
Refresh Screen	CTRL/W	17H
Toggle Status Line/ Toggle Indicators	ESC T	1BH 54H
Toggle Echoplex Enabled	CTRL/V	16H
Initialize Terminal	ESC	1BH 3CH
Request Disconnect	ESC	1BH 3EH

Microterm: ACT.5A Terminal Setup

NOTE

The auxiliary port on the ACT-5A can be used with the LinkUp 5294 Auxiliary Printer facility.

1. Set the Full/Half-Duplex switch at the rear of the cabinet to Full-Duplex operation.
2. To set the terminal and printer baud rates, set the switch corresponding to the desired baud rate. If a baud rate of 110 is selected, be sure the number of Stop bits specified is 2. The baud-rate switches are found on the main logic board.

I/O	Printer Baud Rate
1	8 19200
2	7 9600
3	6 4800
4	5 2400
5	4 1200
6	3 600
7	2 300
8	1 110

3. There are six switches located on the logic board at the rear of the cabinet which control the terminal's parity, word length, and number of stop bits. Set these switches to the following values:

Switch/Option	Value	Comments
5/8th bit transmit	?	OFF = Mark, ON = Space to be transmitted
6 and 7/Word Length	Length =8 =7 =6 =5	6=OFF 7=OFF 6=OFF 7=ON 6=ON 7=OFF 6=ON 7=ON
8/Odd or Even Parity	?	OFF = Even, ON = Odd
9/Number of Stop Bits	ON	Sets the number of stop bits at one. If a baud rate of less than or equal to 110 is being used, set this bit to OFF = 2 stop bits.
10/Parity	?	OFF = No parity, ON = parity selected = switch #8

4. Connect the terminal to the converter with a modem or direct-connect cable, as appropriate.

F.2 ADM11 Terminal Module - Lear Siegler ADM-11

The following list identifies the keyboard sequences defined for the ADM11 Terminal Module.

1. Press <CTRL> concurrently with the indicated alpha key.
2. Press <ESC> prior to pressing the indicated alpha key.
3. The last position of the screen (row 24, column 80) is designed not to display a character. This prevents an automatic scrolling.

5250 Function	Key Sequence	Hex Value Generated
---------------	--------------	---------------------

Cursor Movement

Character Backspace	CTRL/C	03H
Cursor Up	up arrow	0BH
Cursor Down	down arrow	0AH
Cursor Left	left arrow or BACKSPACE	08H
Cursor Right	right arrow	0CH
Field Advance	TAB	09H
Field Backspace	CTRL/B	02H
New Line	CTRL/N	0EH
Fast Left	N.A.	N.A.
Fast Right	N.A.	N.A.

Special Control:

Error Reset	CTRL/R	12H
Insert Mode	CTRL/U	15H
Delete	DEL	7FH
Erase Input	CTRL/E or ESC Y	05H 1BH 59H
Home	HOME	1EH

Field Exit

Duplicate	CTRL/D	04H
Field Minus	CTRL/F	06H
Field Plus	N A.	N A.
Field Exit	CTRL/X	18H

Aid Generating

Enter	RETURN/ENTER	0DH
Clear	ESC Z	1BH SAH
Help	ESC H	1BH 48H
Print	CTRL/P	10H
Roll Up	ESC U	1BH SSH
Roll Down	ESCD	1BH 44H
CMD 1	ESC 1	1BH 31H
CMD 2	ESC 2	1BH 32H
CMD 3	ESC 3	1BH 33H
CMD 4	ESC 4	1BH 34H
CMD 5	ESC 5	1BH 35H
CMD 6	ESC 6	1BH 36H

5250 Function	Key Sequence	Hex Value Generated
CMD 7	ESC 7	1BH 37H
CMD 8	ESC 8	1BH 38H
CMD 9	ESC 9	1BH 39H
CMD 10	ESC 0	1BH 30H
CMD 11	ESC -	1BH 2DH
CMD 12	ESC =	1BH 3DH
CMD 13	ESC !	1BH 21H
CMD 14	ESC @	1BH 40H
CMD 15	ESC #	1BH 23H
CMD 16	ESC \$	1BH 24H
CMD 17	ESC %	1BH 25H
CMD 18	ESC ^	1BH 5EH
CMD 19	ESC &	1BH 26H
CMD 20	ESC *	1BH 2AH
CMD 21	ESC (1BH 28H
CMD 22	ESC)	1BH 29H
CMD 23	ESC _	1BH SFH
CMD 24	ESC +	1BH 2BH

Special Host:

System Request	ESC S	1BH 53H
----------------	-------	---------

Signal:

Attn	ESC A	1BH 41H
------	-------	---------

Extended Function:

Local Copy Print Req.	ESC P	1BH 50H
Local Copy Form Feed	ESC F	1BH 46H
Cancel Print	ESC C	1BH 43H
Refresh Display	CTRL/W	17H
Toggle Status Line/ Toggle Indicators	ESC T	1BH 54H
Toggle Echoplex Enabled	CTRL/V	16H
Initialize Terminal	ESC <	1BH 3CH
Request Disconnect	ESC >	1BH 3EH

Lear Siegler: ADM-11 Terminal Setup

Information on the Lear Siegler ADM-11 terminal switch settings was not available at the time that this document was published. Please refer to the ADM-11 user's manual, or contact your supplier.

NOTE

The auxiliary port on the ADM-11 terminal can be used with the LinkUp 5294 Auxiliary Printer facility.

F.3 ADM21 Terminal Module - Lear Siegler ADM-21

The following list identifies the key sequences defined for the ADM21 Terminal Module.

1. Press <CTRL> concurrently with the indicated alpha key.
2. Press <ESC> prior to pressing the indicated alpha key.
3. NK denotes that the indicated key is found in the Numeric Keypad at the lower right of the keyboard (the LinkUp 5294 sets the keypad to Alternate Keypad mode).
4. The last position of the screen (row 24, column 80) is designed not to display a character. This prevents an automatic scrolling.

5250 Function	Key Sequence	Hex Value Generated
<i>Cursor Movement:</i>		
Backspace Cursor	CTRL/C	03H
Cursor Down	down arrow	0AH
Cursor Up	up arrow	0BH
Cursor Right	right arrow	0CH
Cursor Left	left arrow	08H
Field Advance	CTRL/I or TAB	09H 09H
Field Backspace	CTRL/B	02H
Newline	CTRL/N	0EH
Fast Left	N.A.	N.A.
Fast Right	N.A.	N.A.
<i>Special Control:</i>		
Error Reset	CTRL/R	12H
Insert Mode	CHAR INSERT (F5) or LINE INSERT	01H 44H 0DH 01H 42H 0DH
Delete Char	DEL	7FH
Erase Input	CTRL/E	05H
Home Cursor	HOME	1EH
<i>Field Exit:</i>		
Duplicate	CTRL/D	04H
Field Minus	CTRL/F	06H
Field Plus	N.A.	N.A.
Field Exit	CTRL/X	18H
<i>Aid Generating:</i>		
Enter	ENTER	0DH
Char	PAGE ERASE	01H41H0DH
Help	ESC H	1BH48H
Print	CTRL/P	10H
Roll Up	ESC U	1BH 55H
Roll Down	ESC D	1BH 44H
CMD 1	ESC 1	1BH 31H
CMD 2	ESC 2	1BH 32H
CMD 3	ESC 3	1BH 33H

APPENDIX F: Terminal Modules and ASCII Terminal Setups

5250 Function	Key Sequence	Hex Value Generated
CMD 4	ESC 4	1BH 34H
CMD 5	ESC 5	1BH 35H
CMD 6	ESC 6	1BH 36H
CMD 7	ESC 7	1BH 37H
CMD 8	ESC 8	1BH 38H
CMD 9	ESC 9	1BH 39H
CMD 10	ESC 0	1BH 30H
CMD 11	ESC -	1BH 2DH
CMD 12	ESC =	1BH 3DH
CMD 13	ESC !	1BH 21H
CMD 14	ESC @	1BH 40H
CMD 15	ESC #	1BH 23H
CMD 16	ESC \$	1BH 24H
CMD 17	ESC %	1BH 25H
CMD 18	ESC ^	1BH 5EH
CMD 19	ESC &	1BH 26H
CMD 20	ESC *	1BH 2AH
CMD 21	ESC (1BH 28H
CMD 22	ESC)	1BH 29H
CMD 23	ESC _	1BH SFH
CMD 24	ESC +	1BH 2BH

Special Host:

System Request	ESC S	1BH 50H
----------------	-------	---------

Signal:

Attention	ESC A	1BH 41H
-----------	-------	---------

Extended Function:

Local Copy Print Req.	ESC P	1BH 50H
Local Copy Form Feed	ESC F	1BH 46H
Cancel Print	ESC C	1BH 43H
Refresh Display	SEND PAGE or CTRL/W	01H 47H 0DH 17H
Toggle Status Line/ Toggle Indicators	ESC T	1BH 54H
Toggle Echoplex Enabled	ESC V	1BH 7C
Initialize Terminal	ESC <	1BH 3CH
Request Disconnect	ESC >	1BH 3EH

Lear Siegler: ADM-21 Terminal Setup

NOTE

The auxiliary port on the ADM-21 terminal can be used with the LinkUp 5294 Auxiliary Printer facility.

LINKUP 5294 WITH DL5294 FIRMWARE

1. There are 10 toggle-type switches on the terminal's back panel labeled as S1 switches. These switches are used to specify terminal operating characteristics. Set these switches in the following manner:

Switch	Set To:	Comments
EDIT-FUNC	FUNC	Sets Alternate mode with edit keys
CURSOR BLINK- CURSOR STEADY	?	Set as desired
CARRIAGE RETURN-CARR RETURN		Disables automatic New Line NEW LINE function
PARITY (Sw. 4 and 5)	ODD	Sw4 = Down, Sw5 = Down
	EVEN	Sw4 = Down, Sw5 = Up
	MARK	Sw4 = Up, Sw5 = Down
	SPACE	Sw4 = Up, Sw5 = Up
HALF DUPLEX/ FULL DUPLEX	FULL DUPLEX	Full Duplex operation enabled
60 HZ-50 HZ	?	To match input power frequency
AT4	Switch UP	AT4 not used
CGS1	Switch UP	CGS1 not used
CGS2	Switch DOWN	CGS2 char select option enabled

2. There are 10 toggle-type switches on the terminal's Back panel labeled as S2 switches. These switches set the baud rate and specify functional terminal operating characteristics. Set these switches in the following manner;

S2 Switch	Set To:	Comments
BAUD RATE (SW: 1-7)		See #3 below for switch settings
BUSY DIS-BUSY EN	Busy DIS	Disable BUSY control function
REV VIDEO ON/ REV VIDEO OFF	?	Set Reverse Video function as desired

3. The remaining switches on the back panel are used to set the baud rate for communications to the converter. To set the baud rate, set the switch next to the desired baud rate to the UP position as specified on the ADM-21 back panel (S2) switch group. All other switches must be set to the DOWN position. Note that only one switch is enabled for the desired baud rate unless 110 is to be selected. To set a baud rate of 110, set Switches 1, 3, 5, 6, 7, and 8 to the UP position and Switches 2 and 4 to the DOWN position.

NOTE

If a baud rate of 110 is selected, be sure the number of stop bits specified is 2.

4. Connect the terminal to the LinkUp 5294 with a modem or direct connect cable, as appropriate.

F.4 ADM3A Terminal Module - Lear Siegler ADM-3A

The following list identifies the key sequences defined for the ADM3A Terminal Module.

1. Press <CTRL> concurrently with the indicated alpha key.
2. Press <ESC> prior to pressing the indicated alpha key.

5250 Function	Key Sequence	Hex Value Generated
<i>Cursor Movement:</i>		
Character Backspace	CTRL/C	03H
Cursor Up	CTRL/K	0BH
Cursor Down	LINE FEED or CTRL/J	0AH 09H
Cursor Left	CTRL/H	08H
Cursor Right	CTRL/L	0CH
Field Advance	CTRL/I or TAB	09H 09H
Field Backspace	CTRL/B	02H
New Line	CTRL/N	0EH
Fast Left	N A.	N.A.
Fast Right	N.A.	N.A.
<i>Special Control</i>		
Error Reset	CTRL/R	12H
Insert Mode	CTRL/U	15H
Delete	RUB	7FH
Erase Input	CTRL/E	05H
Home	HOME	01H
<i>Field Exit</i>		
Duplicate	CTRL/D	04H
Field Minus	CTRL./F	06H
Field Plus	N A.	N.A.
Field Exit	CTRL/X	18H
<i>Aid Generation</i>		
Enter	RETURN	0DH
Clear	ESC Z	1BH 5AH
Help	ESC H	1BH 48H
Print	CTRL/P	10H
Roll Up	ESC U	1BH 55H
Roll Down	ESC D	1BH 44H
CMD 1	ESC 1	1BH 31H
CMD 2	ESC 2	1BH 32H
CMD 3	ESC 3	1BH 33H
CMD 4	ESC 4	1BH 34H
CMD 5	ESC 5	1BH 35H
CMD 6	ESC 6	1BH 36H
CMD 7	ESC 7	1BH 37H
CMD 8	ESC 8	1BH 38H

LINKUP 5294 WITH DL5294 FIRMWARE

5250 Function	Key Sequence	Hex Value Generated
CMD 9	ESC 9	1BH 39H
CMD 10	ESC 0	1BH 30H
CMD 11	ESC -	1BH 2DH
CMD 12	ESC =	1BH 3DH
CMD 13	ESC !	1BH 21H
CMD 14	ESC @	1BH 40H
CMD 15	ESC #	1BH 23H
CMD 16	ESC \$	1BH 24H
CMD 17	ESC %	1BH 25H
CMD 18	ESC ^	1BH 5EH
CMD 19	ESC &	1BH 26H
CMD 20	ESC *	1BH 2AH
CMD 21	ESC (1BH 28H
CMD 22	ESC)	1BH 29H
CMD 23	ESC _	1BH 51H
CMD 24	ESC +	1BH 2BH

Special Host

System Request	ESC S	1BH 52H
----------------	-------	---------

Signal

Attn	ESC A	1BH 41H
------	-------	---------

Extended Function

Local Copy Print Req.	ESC P	1BH 50H
Local Copy Form Feed	ESC F	1BH 46H
Cancel Print	ESC C	1BH 43H
Refresh Screen	CTRL/V	17H
Toggle Status Line/ Toggle Indicators	ESC T	1BH 54H
Toggle Echoplex Enabled	CTRL/V	16H
Initialize Terminal	ESC <	1BH 3CH
Request Disconnect	ESC >	1BH 7EH

Lear Siegler: ADM-3A Terminal Setup

1. Disconnect the AC power cord from the outlet before opening the ADM-3A case.
2. There are 13 toggle-type switches on the terminal's circuit board. These switches are used to specify terminal operating characteristics. Set these switches in the following manner

Switch	Set To:	Comments
SPACE-ADV	SPACE	Destructive cursor
UC DISP-U/L DISP	U/L DISP	Allows display of upper- and lower-case characters (if terminal has this option)
DISABLE-KB LOCK	KB LOCK	Allows keyboard lock
DISABLE CLR SCRN	CLR SCRN	Clear Screen position
50 HZ - 60 HZ	?	To match input power frequency
12 LINE-24 LINE	24 LINE	24-line display

APPENDIX F: Terminal Modules and ASCII Terminal Setups

Switch	Set To:	Comments
CUR CTL-OFF	CUR CTL	Specify cursor control
LOCAL-OFF	?	Set as appropriate
103-OFF	?	Set as appropriate
202-OFF	OFF	Half-duplex I/O not allowed
CODE-SEC		Active only if 202 is on
ETX-OFF	OFF	Off since 202 is off
EOT-OFF	OFF	Off since 202 is off

3. There are 20 toggle-type switches on the ADM-3A's front panel. These switches are used to specify the terminal's primary operating characteristics and may be accessed by removing (unscrewing) the identification plate on the keyboard. Set these switches in the following manner:

Switch	Set To:	Comments
BIT 8 - 0/1	0	Forces Bit 8 to zero. Set this switch only if parity is not set; this switch and a PARITY switch are mutually exclusive.
PARITY-INH	?	If parity is to be set, set Parity; otherwise, set to INH. Parity is set to match parity for the converter port. If no parity, set Bit 8 (see above).
STOP 1-2	?	Set as appropriate
DATA 7-8	8	8-bit data word length
PAR-ODD-EVEN	?	This switch has effect only with the PARITY-INH switch in the PARITY position. If PARITY is on, select parity to match the parity on the LinkUp 5294's port for this CRT.
LC EN-UC	EN	Allows lower and upper case
AUTO NL-OFF	OFF	Disables auto NEW LINE
RS232-CL	RS232	Selects RS-232C communications at the modem connector on the rear panel
HDX-FDX	FDX	Full-duplex operation

4. The remaining switches on the front panel are used to set the baud rate for communications to the LinkUp 5294. To do this, set the switch next to the desired baud rate to the left-hand position. All other baud switches must be set on the right-hand side; that is, set one switch only. The baud rate specified here must match the baud rate specified for the LinkUp 5294's port to which this terminal is to be connected. If a baud rate of 110 is selected, be sure the number of Stop bits specified is 2.
5. Replace the cover, reconnect the AC power cord, and connect the terminal to the LinkUp 5294 with a modem or direct-connect cable, as appropriate.

F.5 ADM3P Terminal Module - Lear Siegler ADM-3A Emulators

The following list identifies the key sequences defined for the ADM3P Terminal Module.

1. Press <CTRL> concurrently with the indicated alpha key.
2. Press <ESC> prior to pressing the indicated alpha key.
3. The last position of the screen (Row 24, Column 80) is designed not to display a character. This prevents an automatic scrolling.

5250 Function	Key Sequence	Hex Value Generated
---------------	--------------	---------------------

Cursor Movement

Character Backspace	CTRL/C	03H
Cursor Up	CTRL/K	0BH
Cursor Down	LINE FEED or CTRL/J	0AH 09H
Cursor Left	CTRL/H	08H
Cursor Right	CTRL/L	0CH
Field Advance	CTRL/I or TAB	09H 09H
Field Backspace	CTRL/B	02H
New Line	CTRL/N	0EH
Fast Left	N.A.	N.A.
Fast Right	N.A.	N.A.

Special Control:

Error Reset	CTRL/R	12H
Insert Mode	CTRL/U	15H
Delete	RUB	7FH
Erase Input	CTRL/E	05H
Home	HOME	01H

Field Exit

Duplicate	CTRL/D	04H
Field Minus	CTRL/F	06H
Field Plus	N.A.	N.A.
Field Exit	CTRL/X	18H

Aid Generating:

Enter	RETURN	0DH
Clear	ESC Z	1BH 5AH
Help	ESC H	1BH 48H
Print	CTRL/P	10H
Roll Up	ESC U	1BH 55H
Roll Down	ESC D	1BH 44H
CMD 1	ESC 1	1BH 31H
CMD 2	ESC 2	1BH 32H
CMD 3	ESC 3	1BH 33H
CMD 4	ESC 4	1BH 34H
CMD 5	ESC 5	1BH 35H

5250 Function	Key Sequence	Hex Value Generated
CMD 6	ESC 6	1BH 36H
CMD 7	ESC 7	1BH 37H
CMD 8	ESC 8	1BH 38H
CMD 9	ESC 9	1BH 39H
CMD 10	ESC 0	1BH 30H
CMD 11	ESC -	1BH 2DH
CMD 12	ESC =	1BH 3DH
CMD 13	ESC !	1BH 21H
CMD 14	ESC @	1BH 40H
CMD 15	ESC #	1BH 23H
CMD 16	ESC \$	1BH 24H
CMD 17	ESC %	1BH 25H
CMD 18	ESC ^	1BH SEH
CMD 19	ESC &	1BH 26H
CMD 20	ESC *	1BH 2AH
CMD 21	ESC (1BH 28H
CMD 22	ESC)	1BH 29H
CMD 23	ESC _	1BH SFH
CMD 24	ESC +	1BH 2BH

Special Host:

System Request	ESC S	1BH 52H
----------------	-------	---------

Signal:

Attn	ESC A	1BH 41H
------	-------	---------

Extended Function:

Local Copy Print Req.	ESC P	1BH 50H
Local Copy Form Feed	ESC F	1BH 46H
Cancel/Print	ESC C	1BH 43H
Refresh Screen	CTRL/W	17H
Toggle Status Line/ Toggle Indicators	ESC T	1BH 54H
Toggle Echoplex Enabled	CTRL/V	16H
Initialize Terminal	ESC <	1BH 3CH
Request Disconnect	ESC >	1BH 7EH

ADM-3A Emulation Terminal Setup

The ADM3P Terminal Module was designed to support those terminals and software packages providing emulation of an ADM-3A terminal, the ADM3P Terminal Module was designed. It is different from the standard ADM3P Terminal module because in many cases the emulation provided by software emulators is only partial.

The ADM3P Module differs from the ADM3A in the following respects:

1. On the ADM3A, the LinkUp 5294 allows display of a character in the last position on the screen (row 24, column 80) since it is possible to defeat the ADM3A auto-scroll capability with a switch setting. Most ADM3A emulators scroll when a character is displayed in the last position, so the ADM3P driver prevents display of data at Row 24, Column 80.

2. The ADM3A provides no support for high/low intensity. The ADM3P will select high and low intensity with ESC) and ESC (, respectively.
3. The ADM3A does not provide an auxiliary part, so it cannot work with the LinkUp 5294 Auxiliary Printer facility. The ADM3P module, however, allows you to select and deselect an auxiliary port with CTRL/N and CTRL/O, respectively. These sequences are adapted from the Lear Siegler ADM3A Plus and ADM5 terminals and also function as keyboard unlock and lock, respectively, unless the appropriate switch has been optioned, as follows:
 - S4 on the ADM5 terminal is in the GT position, or
 - AUX/KB switch on the QUME 102 set to AUX

However, since most of the ADM3A emulations do not support transparent operation of an auxiliary port, the screen will also receive the printer output. Therefore, do not use the auxiliary printer facility unless you are sure that your emulator will accept the port-select commands.

In all other respects, the ADM3A and ADM3P modules are the same. For information on setting up a terminal or PC emulating an ADM3A terminal, refer to the following:

- The ADM3A entry in this manual
- The terminal or PC manufacturer's documentation

F.6 ANSI Terminal Module - ANSI Standard 3.64

The following list identifies the key sequences defined for the ANSI Terminal Module.

1. Press <CTRL> concurrently with the indicated alpha key.
2. Press <ESC> prior to pressing the indicated alpha key.

5250 Function	Key Sequence	Hex Value Generated
<i>Cursor Movement:</i>		
Character Backspace	BACKSPACE	03H
CursorUp	up arrow	1BH 5BH 41H
Cursor Down	down arrow	1BH 5BH 42H
Cursor Left	left arrow	1BH 5BH 44H
CursorRight	right arrow	1BH 5BH 43H
Field Advance	TAB	09H
Field Backspace	CTRL/B	02H
New Line	CTRL/N	0EH
Fast Left	N.A.	N.A.
Fast Right	N.A.	N.A.

Special Control:

Error Reset	CTRL/R	12H
Insert Mode	CTRL/UU	15H
Delete	DEL	7FH
Erase Input	CTRL/E	05H
Home	CTRL/H	08H

APPENDIX F: Terminal Modules and ASCII Terminal Setups

5250 Function	Key Sequence	Hex Value Generated
---------------	--------------	---------------------

Field Exit:

Duplicate	CTRL/D	04H
Field Minus	CTRL/F	06H
Field Plus	N A.	N A.
Field Exit	CTRL/X	18H

Aid Generating:

Enter	ENTER	0DH
Clear	CTRL/Z	1AH
Help	ESC H	1BH 48H
Print	CTRL/P	10H
Roll Up	ESC U	1BH 55H
Roll Down	ESC D	1BH 44H
CMD 1	ESC 1	1BH 31H
CMD 2	ESC 2	1BH 32H
CMD 3	ESC 3	1BH 33H
CMD 4	ESC 4	1BH 34H
CMD 5	ESC 5	1BH 35H
CMD 6	ESC 6	1BH 36H
CMD 7	ESC 7	1BH 37H
CMD 8	ESC 8	1BH 38H
CMD 9	ESC 9	1BH 39H
CMD 10	ESC 0	1BH 30H
CMD 11	ESC -	1BH 2DH
CMD 12	ESC =	1BH 3DH
CMD 13	ESC !	1BH 21H
CMD 14	ESC @	1BH 40H
CMD 15	ESC #	1BH 23H
CMD 16	ESC \$	1BH 24H
CMD 17	ESC %	1BH 25H
CMD 18	ESC ^	1BH 5EH
CMD 19	ESC &	1BH 26H
CMD 20	ESC *	1BH 2AH
CMD 21	ESC (1BH 28H
CMD 22	ESC)	1BH 29H
CMD 23	ESC _	1BH 5FH
CMD 24	ESC +	1BH 2BH

Special Host:

System Request	ESC 5	1BH 53H
----------------	-------	---------

Signal:

Attn	ESC A	1BH 41H
------	-------	---------

5250 Function	Key Sequence	Hex Value Generated
<i>Extended Function:</i>		
Local Copy Print Req.	ESC P	1BH 50H
Local Copy Form Feed	ESC F	1BH 46H
Cancel Print	ESC C	1BH 43H
Refresh Screen	CTRL/W	17H
Toggle Status Line/ Toggle Indicators	ESC T	1BH 54H
Toggle Echoplex Enabled	CTRL/V	16H
Initialize Terminal	ESC <	1BH 3CH
Request Disconnect	ESC >	1BH 3EH

ANSI Standard: 3.64 Terminal Setup

NOTE

The ANSI module may be used with terminals and PCs emulating VT100 terminals without numeric keypad support; for those which do support a numeric keypad, the VT100 module may be used.

Information on the setup of any terminal complying with the ANSI Standard 3.64 will depend on the particular terminal being used. Please refer to the manufacturer's user's manual or contact your supplier.

F.7 COMPU Terminal Module

COMPU is designed to support communication programs written especially for mini, micro, or instrumentation computers (those other than the IBM PC and compatibles, which the IBMPC and T5250 modules support) to enable them to transfer data to and from the System/3X host through the LinkUp 5294. A comparable program on the System/3X host must also be written in order to let the host know what is going on.

The COMPU module ensures that only data is sent to your computer; that is, no intensity or cursor-positioning sequences are ever sent, even if the host requests them. This enables the data sent from the System/3X host to the LinkUp 5294 to be converted and sent out the LinkUp 5294 asynchronous port to your computer in the same order the LinkUp 5294 received it and vice versa. The LinkUp 5294 does not perform any screen optimization when updating your screen of data (normally, the LinkUp 5294 updates your screen with only new data); instead it simply retransmits your entire screen every time.

When using one of the other terminal modules, the LinkUp 5294 discards any data received from your terminal or PC when the System/3X host inhibits your keyboard input. However, with COMPU, the LinkUp 5294 buffers the data until the host uninhibits your keyboard input, then sends the buffered data to the host. This permits a computer (using COMPU) to continuously send data to the LinkUp 5294 without regard to whether keyboard input is inhibited or not. (With this capability, the LinkUp 5294 exercises flow control to your computer as necessary to avoid overrunning its buffers.)

NOTE

The COMPU module performs the normal ASCII-to-EBCDIC and EBCDIC-to-ASCII translations of the data handled by the LinkUp 5294. Additionally, the key sequences defined for its emulation keyboard functions are identical to those used for the ADM3A Terminal Module.

F.8 C7101 Terminal Module - C. Itoh CIE 7101

The following list identifies the key sequence defined for the C7101 Terminal Module.

1. Press <CTRL> concurrently with the indicated alpha key.
2. Press <ESC> prior to pressing the indicated alpha key.

5250 Function	Key Sequence	Hex Value Generated
<i>Cursor Movements:</i>		
Character Backspace	BACKSPACE	08H
Cursor Up	up arrow or F7	1BH 5BH 41H 1BH 5BH 3 1H 37H 7EH
Cursor Down	down arrow or F8	1BH 5BH 42H 1BH 5BH 31H 38H 7EH
Cursor Left	left arrow or F9	1BH 5BH 44H 1BH 5BH 31H 39H 7EH
Cursor Right	right arrow or F10	1BH 5BH 43H 1BH 5BH 32H 30H 7EH
Field Advance	TAB	09H
Field Backspace	SHIFT/TAB	1BH 5BH 5AH
New Line	HOME	1BH 5BH 48H
Fast Left	SHIFT/F9	1BH 5BH 31H 39H 3BH 31H 7EH
Fast Right	SHIFT/F10	1BH 5BH 32H 30H 3BH 31H 7EH
<i>Special Control:</i>		
Error Reset	CTRL/R or PF1	12H 1BH 4FH 50H
Insert Mode	F3 or INS	1BH 5BH 31H 33H 7EH 1BH 5BH 32H 7EH
Delete	DEL or SHIFT/F3 or DEL/BREAK	7FH 1BH 5BH 31H 33H 3BH 31H 7EH 1BH 5BH 33H 7EH
Erase Input Home	SHIFT/F4 F4	1BH 5BH 31H 34H 3BH 31H 7EH 1BH 5BH 31H 34H 7EH
<i>Field Exit:</i>		
Duplicate	PF2	1BH 4FH 51H
Field Minus	PF4	1BH 4FH 53H
Field Plus	PF3	1BH 4FH 52H
Field Exit	RETURN	0DH
<i>Aid Generating:</i>		
Enter	LINE FEED	0AH
Clear	ESC BACKSPACE	1BH 08H
Help	F6 or SHIFT/F6	1BH 5BH 31H 36H 7EH 1BH 5BH 31H 36H 3BH 31H 7EH
Print	F5	1BH 5BH 31H 35H 7EH
Roll Up	SHIFT/F7 or PGUP	1BH 5BH 31H 37H 3BH 31H 7EH 1BH 5BH 35H 7EH

LINKUP 5294 WITH DL5294 FIRMWARE

5250 Function	Key Sequence	Hex Value Generated
Roll Down	SHIFT/F8 or PG DOWN	1BH 5BH 31H 38H 3BH 31H 7EH 1BH 5BH 36H 7EH
CMD	F2 or SHIFT/F2	1BH 5BH 31H 32H 7E 1BH 5BH 31H 32H 3BH 31H 7EH
CMD 1	PF1	1BH 5BH 32H 31H 7EH
CMD 2	PF2	1BH 5BH 32H 32H 7EH
CMD 3	PF3	1BH 5BH 32H 33H 7EH
CMD 4	PF4	1BH 5BH 32H 34H 7EH
CMD 5	PF5	1BH 5BH 32H 35H 7EH
CMD 6	PF6	1BH 5BH 32H 36H 7EH
CMD 7	PF7	1BH 5BH 32H 37H 7EH
CMD 8	PF8	1BH 5BH 32H 38H 7EH
CMD 9	PF9	1BH 5BH 32H 39H 7EH
CMD 10	PF10	1BH 5BH 33H 30H 7EH
CMD 11	PF11	1BH 5BH 33H 31H 7EH
CMD 12	PF12	1BH 5BH 33H 32H 7EH
CMD 13	PF13	1BH 5BH 33H 33H 7EH
CMD 14	PF14	1BH 5BH 33H 34H 7EH
CMD 15	PF15	1BH 5BH 33H 35H 7EH
CMD 16	PF16	1BH 5BH 33H 36H 7EH
CMD 17	PF17	1BH 5BH 33H 37H 7EH
CMD 18	PF18	1BH 5BH 33H 38H 7EH
CMD 19	PF19	1BH 5BH 33H 39H 7EH
CMD 20	PF20	1BH 5BH 34H 30H 7EH
CMD 21	PF21	1BH 5BH 34H 31H 7EH
CMD 22	PF22	1BH 5BH 34H 32H 7EH
CMD 23	PF23	1BH 5BH 34H 33H 7EH
CMD 24	PF24	1BH 5BH 34H 34H 7EH
<i>Special Host:</i>		
System Request	SHIFT/F1	1BH 5BH 31H 31H 3BH 31H 7EH
<i>Signal:</i>		
Attn	F1	1BH 5BH 31H 31H 7EH
<i>Extended Function:</i>		
Local Copy Print Req.	CTRL/P	10H
Local Copy Form Feed	CTRL/F	06H
Cancel Print	SHIFT/F5	1BH 5BH 31H 35H 3BH 31H 7EH
Refresh Display	CTRL/V	17H
Toggle Status Line/ Toggle Indicator	ESC T	1BH 54H
Toggle Echoplex Enabled	CTRL/V	16H
Initialize Terminal	ESC <	1BH 3CH
Request Disconnect	ESC >	1BH 7EH

CITOH: CIE 7101 Terminal Setup

To enter Setup mode on the C. Itoh 7101 terminal, power on the terminal, then press SHIFT and SETUP simultaneously. Parameter options and features are displayed along the bottom of the screen. Then select the following settings for each of the Setup options:

Group	Feature	Setting
COMMS	Main	Online
KEYBOARD	Keyboard to Aux Port	Main To Comms
	Auto Rpt	As desired
	Keyclick	As desired
	Keyboard Lang. Keyboard Controls	U.S. (or as desired) VT-100 7-bit
DISPLAY	Cursor	As desired
	Background	As desired
	Frequency	As required
	Insert Line	Blank
	Terminal Mode	VT-100
	Form Feed	As desired
	Scroll	As desired
	New Line	OFF
	Margin Bell	OFF
	No. of Columns	80
	Auto Wrap	OFF
	CRT Saver	As desired
	Status Line	OFF
	G0 Selection	U.S.
G1 Selection	U.S.	
MAIN PORT	Number of Data Lines ²⁴	
	TX, RX (baud rate)	To match LinkUp 5294
	Stop Bits	To match LinkUp 5294
	Parity	To match LinkUP 5294
	RS-422/232C	23C
	Tx Rate Limited	OFF
	Auto X-ON/X-OFF	ON
	Process Rx'd X-OFF	ON
AUX. PORT	Display Controls	OFF
	Baud Rate	As printer requires
	Stop Bits	As printer requires
	Parity	As printer requires
SETUP	Printer Modes	NONE
	Terminal Type	ANSI

1. When setting the Parity option in the terminal configurator, note that 8 bits is allowed even though the keyboard is set for 7-bit controls.
2. The AUX port on the CI7101 can be used with the LinkUp 5294 Auxiliary Printer facility.

F.9 C7103 Terminal Module - C. Itoh CIE 7103

The following list identifies the key sequences defined for the C7103 Terminal Module.

1. Press <CTRL> concurrently with the indicated alpha key.
2. Press <ESC> prior to pressing the indicated alpha key.

5250 Function	Key Sequence	Hex Value Generated
<i>Cursor Movement:</i>		
Character Backspace	BACKSPACE	08H
Cursor Up	up arrow or ESC A	1BH 5BH 41H 1BH 41H
Cursor Down	down arrow or ESC B	1BH 5BH 42H 1BH 42H
Cursor Left	left arrow or ESC D	1BH 5BH 44H 1BH 44H
Cursor Right	right arrow or ESC C	1BH 5BH 43H 1BH 43H
Field Advance	TAB	09H
Field Backspace	BACKTAB	1BH 31H
New Line	ESC I	1BH 49H
Fast Left	ESC 4	1BH 34H
Fast Right	SHIFT/left arrow SHIFT/right arrow	1CH 44H 1CH 43H
<i>Special Control:</i>		
Error Reset	RESET/CANCEL	1BH 51H
Insert Mode	INS	1BH 3SH
Delete	DEL	1BH 36H
Erase Input	ERASE INPUT	1BH 56H
Home	HOME SYMBOL	1BH 48H
<i>Field Exit:</i>		
Duplicate	DUP	1BH 32H
Field Minus	FIELD -	1BH 52H
Field Plus	FIELD +	1BH 4FH
Field Exit	(RETURN)	0DH
<i>Aid Generating:</i>		
Enter	LINE FEED	0AH
Clear	SHIFT/CLEAR	1CH 74H
Help	HELP	1BH 46H
Print	PRINT	1BH 45H
Roll Up	ROLL	1CH 41H
Roll Down	ROLL	1CH 42
CMD	(TOP ROW) or ALT	1BH 19H 18H
CMD 1	CMD 1	1BH 19H 31H

APPENDIX F: Terminal Modules and ASCII Terminal Setups

5250 Function	Key Sequence	Hex Value Generated
CMD 2	CMD 2	1BH 19H 32H
CMD 3	CMD 3	1BH 19H 33H
CMD 4	CMD 4	1BH 19H 34H
CMD 5	CMD 5	1BH 19H 35H
CMD 6	CMD 6	1BH 19H 36H
CMD 7	CMD 7	1BH 19H 37H
CMD 8	CMD 8	1BH 19H 38H
CMD 9	CMD 9	1BH 19H 39H
CMD 10	CMD 10	1BH 19H 30H
CMD 11	CMD 11	1BH 19H 2DH
CMD 12	CMD 12	1BH 19H 3DH
CMD 13	CMD 13	1BH 19H 5DH
CMD 14	CMD 14	1BH 19H 40H
CMD 15	CMD 15	1BH 19H 23H
CMD 16	CMD 16	1BH 19H 24H
CMD 17	CMD 17	1BH 19H 25H
CMD 18	CMD 18	1BH 19H 5EH
CMD 19	CMD 19	1BH 19H 26H
CMD 20	CMD 20	1BH 19H 2AH
CMD 21	CMD 21	1BH 19H 28H
CMD 22	CMD 22	1BH 19H 29H
CMD 23	CMD 23	1BH 19H 5FH
CMD 24	CMD 24	1BH 19H 2BH

Special Host:

Systan Request	SYS REQ	1CH 53H
----------------	---------	---------

Signal:

Attn	ATTN	1BH 53H
------	------	---------

Extended Function:

Local Copy Print Req.	N.A.	N.A.
Local Copy Form Feed	N.A.	N.A.
Cancel Print	SHIFT/PRINT	1CH 45H
Refresh Saen	ESC W	1BH 57H
Toggle Status Line/ Toggle Indicators	ESC T	1BH 54H
Toggle Echoplex Enabled	CTRL/V	16H
Initialize Terminal	ESC <	1BH 3CH
Request Disconnect	ESC >	1BH 3EH

CITOH: CIE 7103 Terminal Setup

To enter Setup mode on the C. Itoh 7103 terminal, power on the terminal, then press SHIFT and SETUP simultaneously, release, and press TAB. Parameter options and features are displayed along the bottom of the screen. (Refer to the terminal operator's guide for details on use of SETUP mode.) Select the following settings for each of the Setup options:

LINKUP 5294 WITH DL5294 FIRMWARE

Group	Feature	Setting
COMMS	Main	Online
	Keyboard to Aux Port	Main
KEYBOARD	Auto Rpt	Input Disabled
	Keyclick	As desired
	Keyboard Lang.	As desired
	Keyboard	U.S. (or as desired)
	Controls	3180-2
	PF function keys	7-bit
		Unshifted
DISPLAY	Cursor	As desired
	Background	As desired
	Frequency	As required
	Insert Line	Blank
	PC AT CG	OFF
	Form Feed	As desired
	Scroll	As desired
	New Line	OFF
	Margin Bell	OFF
	No. of Columns	80
	Auto Wrap	OFF
	CRT Saver	As desired
	G0 Selection	U.S.
	G1 Selection	U.S.
	Number of Data Lines	24
	Erase extent	Page
MAIN PORT	TX, RX (baud rate)	To match LinkUp 5294
	Stop Bits	To match LinkUp 5294
	Parity	To match LinkUp 5294
	RS-422/232C	232C
	Tx Rate Limited	OFF
	RTS/CTS Handshake	OFF
	Main Port Protocol	X-ON/X-OFF
	Process Rx'd X-OFF	ON
	Display Controls	OFF
AUX. PORT	Baud Rate	As printer requires
	Stop Bits	As printer requires
	Parity	As printer requires
	Printer Modes	Ready

1. When setting the Parity option in the terminal configurator, note that 8 bits is allowed even though the keyboard is set for 7-bit controls.
2. The AUX port on the CE 7103 terminal can be used with the LinkUp 5294 Auxiliary Printer facility.
3. The CE 7103 terminal is the only one in the industry which supports unique auxiliary printer handshaking. This means if the CE 7103 detects an X-OFF command or DTR dropping, it will redirect the data (directed to the auxiliary printer) to an auxiliary printer buffer. When the auxiliary printer buffer is almost full, the terminal will send an auxiliary print-inhibit sequence to the LinkUp 5294, which is distinguishable from the flow control of the display, enabling you to continue with your display session uninterrupted. This CE 7103 feature operates successfully up to 9600 baud.

F.10 CY5291 Terminal Module - Cybernex XLB-5291

The following list identifies the key sequences defined for the CY5291 Terminal Module.

1. Press <CTRL> concurrently with the indicated alpha key.
2. Press <ESC> prior to pressing the indicated alpha key.
3. The last position of the screen (row 24, column 80) is designed not to display a character. This prevents an automatic scrolling.

5250 Function	Key Sequence	Hex Value Generated
----------------------	---------------------	----------------------------

Cursor Movement:

Character Backspace	BACKSPACE	1BH 4FH 50H
CursorUp	up arrow	1BH 5BH 41H
Cursor Down	down arrow	1BH 5BH 42H
Cursor Left	left arrow	1BH 5BH 44H
Cursor Right	right arrow	1BH 5BH 43H
Field Advance	TAB	09H
Field Backspace	BACKTAB	1BH 4FH 52H
New Line	LINE FEED	0AH
Fast Left	N A.	N.A.
Fast Right	N A.	N.A.

Special Control:

Error Reset	ERROR RESET	12H
Insert Mode	INS	1BH 4FH 79H
Delete	DEL	7FH
Erase Input	ERASE INPT	1BH 4FH 74H
Home	HOME	1BH 4FH 75H

Field Exit:

Duplicate	DUP	1BH 4FH 53H
Field Minus	FIELD -	1BH 4FH 6DH
Field Plus	FIELD +	1BH 4FH 6CH
Field Exit	FIELD EXIT	0DH

Aid Generating:

Enter	ENTER	1BH 4FH 4DH
Clear	CMD SHIFT/BACKSPACE	1BH 4FH 72H
Help	HELP	1BH 4FH 71H
Print	PRINT	1BH 4FH 76H
Roll Up	ROLL UP	1BH 4FH 70H
Roll Down	ROLL DOWN	1BH 4FH 6EH
CMD 1	CMD 1	1BH 31H
CMD 2	CMD 2	1BH 32H
CMD 3	CMD 3	1BH 33H
CMD 4	CMD 4	1BH 34H
CMD 5	CMD 5	1BH 35H
CMD 6	CMD 6	1BH 36H
CMD 7	CMD 7	1BH 37H

LINKUP 5294 WITH DL5294 FIRMWARE

5250 Function	Key Sequence	Hex Value Generated
CMD 8	CMD 8	1BH 38H
CMD 9	CMD 9	1BH 39H
CMD 10	CMD 0	1BH 30H
CMD 11	CMD -	1BH 2DH
CMD 12	CMD =	1BH 3DH
CMD 13	CMD !	1BH 21H
CMD 14	CMD @	1BH 40H
CMD 15	CMD #	1BH 23H
CMD 16	CMD \$	1BH 24H
CMD 17	CMD %	1BH 2SH
CMD 18	CMD ^	1BH SEH
CMD 19	CMD &	1BH 26H
CMD 20	CMD *	1BH 2AH
CMD 21	CMD (1BH 28H
CMD 22	CMD)	1BH 29H
CMD 23	CMD _	1BH SFH
CMD 24	CMD +	1BH 2BH

Special Host:

System Request	SYS REQ	1BH 4FH 77H
----------------	---------	-------------

Signal:

Attn	ATTN	1BH 4FH 78H
------	------	-------------

Extended Function:

Local Copy Print Req.	CMD PRINT	10H
Local Copy Form Feed	CMD F	06H
Cancel Print	CMD ERROR RESET	03H
Refresh Screen	CMD HOME	17H
Toggle Status Line/ Toggle Indicators	CMD CURSOR UP	1BH 4FH 73H
Toggle Echoplex Enabled	CMD CURSOR DOWN	16H
Initialize Terminal	CMD SYS REQ	1BH 3CH
Request Disconnect	CMD ATTN	1BH 3EH

DEC: Cybernex XLB-S291 Terminal Setup

1. Turn on the Power Switch and enable the Software option switches through the keyboard (SETUP A procedure). SETUP A mode is accomplished by pressing CMD HELP. This mode contains a series of software keys that tailor the terminal to your operating environment. The following values are recommended for interfacing with the LinkUp 5294.

Byte 1 Switches	Set To:	Comments
1 (ECHOPLEX)	Off	LinkUp 5294 handles character echo
2 (FLOW CONTROL)	On	Enable flow control
3 (MARGIN BELL)	?	
4 (AUTO REPEAT)	?	
5 (AUTO WRAP)	Off	Disable auto wrap at Column 80
6,7 (MA~ PARrY)	?	Set Main port parity to agree with the LinkUp 5294

Byte 1 Switches	Set To:	Comments
8, 9 (AUX PARITY)	?	Set Aux port parity to agree with printer
10 (NEWLINE)	Off	RETURN key is CR, not (CR, LF)
11 (CURSOR KEY)	Off	Disable CURSOR APPLICATION mode
12 (APPL KEYS)	APPL	Enable APPLICATION KEYPAD mode
Byte 2 Switches	Set To:	Comments
1 (ANSI 3.64)	On	Enable ANSI 3.64 command mode
2 (LOCK)	?	CAPS LOCK or SHIFT LOCK
3 (PRINT)	REMOTE	PRINT key transmits sequence to the LinkUp 5294
4 (CLM SEPS)	On	Enable Column Separator attribute
5, 6 (CURSOR)	?	Set type of cursor desired
7 (MAIN)	RS-232	Set main port to RS-232 operation
8 (LIGHT PEN)	Off	Disable light-pen operation
9 (COORD SEND)	-	Not applicable if light pen is disabled
10 (STOP BITS)	?	Set to agree with the LinkUp 5294 (usually set to 1)
11 (TRANSPARENCY)	Off	Disable transparency

The SETUP A mode screen gives the facility for setting the appropriate terminal baud rate. Available baud rates are: 300, 600, 1200, 2400, 4800, 9600, 19.2, and 38.4 kbps. Both the main port and the aux. printer port baud rates are set at this menu. The baud rate specified here must match the baud rate for the LinkUp 5294 port to which this terminal is connected.

SETUP A mode screen also provides a setting to customize the terminal operation to particular brands of protocol converter. This PROT setting must be LC DAT to ensure the above keyboard operation.

2. Connect the terminal to the LinkUp 5294 with a modem or direct-connect cable, as appropriate.

F.11 DISPH Terminal Module - Northern Telecom Displayphone

The following list identifies the key sequences defined for the DISPH Terminal Module.

1. Press <CTRL> concurrently with the indicated alpha key.
2. Press <ESC> prior to pressing the indicated alpha key.

5250 Function	Key Sequence	Hex Value Generated
<i>Cursor Movement:</i>		
Character Backspace	CTRL/C	03H
Cursor Up	up arrow	0BH
Cursor Down	down arrow	0AH
Cursor Left	left arrow	08H
Cursor Right	right arrow	09H
Field Advance	CTRL/A	01H
Field Backspace	CTRL/B	02H
New Line	CTRL/N	0EH
Fast Left	N A.	N.A.
Fast Right	N.A.	N A.

LINKUP 5294 WITH DL5294 FIRMWARE

5250 Function	Key Sequence	Hex Value Generated
<i>Special Control:</i>		
Error Reset	CTRL/R	12H
Insert Mode	CTRL/U	15H
Delete	DEL	7FH
Erase Input	CTRL/E	05H
Home	CTRL/^	1EH
<i>Field Exit:</i>		
Duplicate	CTRL/D	04H
Field Minus	CTRL/F	06H
Field Plus	N.A.	N.A.
Field Exit	CTRL/X	18H
<i>Aid Generating:</i>		
Enter	ENTER	0DH
Clear	ESC L	1BH 4CH
Help	ESC H	1BH 48H
Print	CTRL/P	10H
Roll Up	ESC U	1BH 55H
Roll Down	ESC D	1BH 44H
CMD 1	ESC 1	1BH 31H
CMD 2	ESC 2	1BH 32H
CMD 3	ESC 3	1BH 33H
CMD 4	ESC 4	1BH 34H
CMD 5	ESC 5	1BH 35H
CMD 6	ESC 6	1BH 36H
CMD 7	ESC 7	1BH 37H
CMD 8	ESC 8	1BH 38H
CMD 9	ESC 9	1BH 39H
CMD 10	ESC 0	1BH 30H
CMD 11	ESC -	1BH 2DH
CMD 12	ESC =	1BH 3DH
CMD 13	ESC !	1BH 21H
CMD 14	ESC @	1BH 40H
CMD 15	ESC #	1BH 23H
CMD 16	ESC \$	1BH 24H
CMD 17	ESC %	1BH 25H
CMD 18	ESC ^	1BH 5EH
CMD 19	ESC &	1BH 26H
CMD 20	ESC *	1BH 2AH
CMD 21	ESC (1BH 28H
CMD 22	ESC)	1BH 29H
CMD 23	ESC _	1BH 5FH
CMD 24	ESC +	1BH 2BH
<i>Special Host:</i>		
System Request	ESC 5	1BH 53H

5250 Function	Key Sequence	Hex Value Generated
<i>Signal:</i>		
Attn	ESC A	1BH 41H
<i>Extended Function:</i>		
Local Copy Print Req.	ESC P	1BH 50H
Local Copy Form Feed	ESC F	1BH 46H
Cancel Print	ESC C	1BH 43H
Refresh Screen	CTRL/W or ESC G	17H 1BH 47H
Toggle Status Line/ Toggle Indicator	ESC T	1BH 54H
Toggle Echoplex Enabled	CTRL/V	16H
Initialize Terminal	ESC <	1BH 3CH
Request Disconnect	ESC >	1BH 3EH

Northern Telecom: Displayphone Terminal Setup

The Displayphone does not use DIP switches for options. Instead, options are selected through the keyboard.

Dial-up Connection

1. A telephone jack must be plugged into Line 2 (on back of the Displayphone).
2. Turn terminal on.
3. Press Services key.
4. Select 4 (DISPLAYPHONE UTILITIES).
5. Select 2 (MANUAL DATA CALL PROFILE).

WIDTH	MODE	DUPLEX	PARITY
80	P	F	(set to match the converter)

6. Press Exit to store data.
7. Press Services again.
8. Press Line 2 and manually dial the telephone number.
9. Press Data Soft key for connection.
10. To hang up, press Line 2 and then press Release.

NOTE

1. Use Line 2 for data calls.
2. Maximum baud rate for dial-up is 1200 baud.

Direct Connection:

1. Connect the RS-232 cable to the back of the Displayphone at the port marked RS-232.
2. Turn the terminal on.
3. Press Service.
4. Select 3 - Local Data Port.

Local RS-232 Data Port should be ON.

Set baud rates

Press Exit

WIDTH	MODE	DUPLEX	PARITY
80	P	F	(set to match converter)

Press Exit to store data.

5. Press Screen key.

NOTE

The maximum baud rate for the Displayphone when directly connected is 9600.

6. Connect the terminal to the LinkUp 5294 with a modem or direct connect cable, as appropriate.

F.12 D200 Terminal Module - Data General Dasher 200

The following list identifies the key sequences defined for the D200 Terminal Module.

1. Press <CTRL> concurrently with the indicated alpha key.
2. Press <ESC> prior to pressing the indicated alpha key.

5250 Function	Key Sequence	Hex Value Generated
<i>Cursor Movement:</i>		
Character Backspace	CTRL/C	03H
Cursor Up	up arrow	17H
Cursor Down	down arrow	1AH
Cursor Left	left arrow	19H
Cursor Right	right arrow	18H
Field Advance	TAB	09H
Field Backspace	F14	1EH 7EH
New Line	NEW LINE	0AH
Fast Left	SHIFT left arrow	1EH 18H
Fast Right	SHIFTright arrow	1EH 19H

APPENDIX F: Terminal Modules and ASCII Terminal Setups

5250 Function	Key Sequence	Hex Value Generated
<i>Special Control:</i>		
Error Resct	CTRL/R or F5	12H 1EH 75H
Insert Mode	F2 or C1	1EH 72H 1EH 5CH
Delete	DEL or SHIFT C1 or SHIFT F2	7FH 1EH 58H 1EH 62H
Erase Input	ERASE EOL or SHIFT F3	0BH 1EH 63H
Home	HOME or F3	08H 1EH 73H
<i>Field Exit:</i>		
Duplicate	F15	1EH 70H
Field Menus	C2	1EH SDH
Field Plus	C4	1EH 5FH
Field Exit	CR	0DH
<i>Aid Generating:</i>		
Enter	C3	1EH 5EH
Clear	PAGE ERASE	0CH
Help	F6	1EH 76H
Print	F4	1EH 74H
Roll Up	SHIFT up arrow	1EH 17H
Roll Down	SHIFT down arrow	1EH 1AH
CMD 1	ESC 1	1BH 31H
CMD 2	ESC 2	1BH 32H
CMD 3	ESC 3	1BH 33H
CMD 4	ESC 4	1BH 34H
CMD 5	ESC 5	1BH 35H
CMD 6	ESC 6	1BH 36H
CMD 7	ESC 7	1BH 37H
CMD 8	ESC 8	1BH 38H
CMD 9	ESC 9	1BH 39H
CMD 10	ESC 0	1BH 30H
CMD 11	ESC -	1BH 2DH
CMD 12	ESC =	1BH 3DH
CMD 13	ESC !	1BH 21H
CMD 14	ESC @	1BH 40H
CMD 15	ESC #	1BH 23H
CMD 16	ESC \$	1BH 24H
CMD 17	ESC %	1BH 25H
CMD 18	ESC ^	1BH 5EH
CMD 19	ESC &	1BH 26H
CMD 20	ESC *	1BH 2AH
CMD 21	ESC (1BH 28H
CMD 22	ESC)	1BH 29H
CMD 23	ESC _	1BH 5FH
CMD 24	ESC +	1BH 2BH

LINKUP 5294 WITH DL5294 FIRMWARE

5250 Function	Key Sequence	Hex Value Generated
<i>Special Host:</i>		
System Request or SHIFT F1	ESC S	1BH 53H 1EH 61H
<i>Signal:</i>		
Attn:	ESCA or F1	1BH 41H 1EH 71H
<i>Extended Function:</i>		
Local Copy Print Req.	F9	1EH 79H
Local Copy Form Feed	F10	1EH 7AH
Cancel Print	SHIFT F4	1EH 64H
Refresh Screen	F7	1EH 77H
Toggle Status Line/ Toggle Indicators	F8	1EH 78H
Toggle Echoplex Enabled	F11	1EH 7BH
Initialize Terminal	ESC <	1BH 3CH
Request Disconnect	ESC >	1BH 3EH

Data General: DASHER 200 Terminal Setup

1. Disconnect the AC power cord from the outlet before opening the Dasher 200 case.
2. Use the 8 toggle-type switches on the back to set the parity and baud rate as shown on the next page. (Switches 7 and 8 are unused.)

BAUD RATE	SWITCHES				PARITY	SWITCHES	
	1	2	3	4		5	6
19200	1	1	1	1	Even	1	1
9600	1	1	1	0	Mark	1	0
7200	1	1	0	1	Odd	0	1
4800	1	1	0	0	None	0	0
3600	1	0	1	1			
2400	1	0	1	0			
1800	1	0	0	1			
1200	1	0	0	0			
600	0	1	1	1			
300	0	1	1	0			
150	0	1	0	1			
134.5	0	1	0	0			
110	0	0	1	1			
75	0	0	1	0			
50	0	0	0	1			
50	0	0	0	0			

3. There are 4 switches inside the terminal case which control the printer interface characteristics. These settings are irrelevant, as the auxiliary printer feature is not supported on this terminal.

4. Replace the cover, reconnect the AC power cord, and connect the terminal to the LinkUp 5294 with a modem or direct-connect cable, as appropriate.

NOTE

Data General terminals do not use industry-standard sequences for character backspace and cursor control. Consequently, to use the LinkUp 5294 configurator with this terminal you must make no mistakes in typing, since an attempt to backspace the cursor to correct a mistake will send the cursor home instead.

F.13 HP45 Terminal Module - Hewlett Packard HP-2645

The following list identifies the key sequences defined for the HP45 Terminal Module.

1. Press <CTRL> concurrently with the indicated alpha key.
2. Press <ESC> prior to pressing the indicated alpha key.

5250 Function	Key Sequence	Hex Value Generated
<i>Cursor Movement:</i>		
Character Backspace	CTRL/C or BACKSPACE	03H 08H
Cursor Up	up arrow	1BH 41H
Cursor Down	down arrow	1BH 42H
Cursor Left	left arrow	1BH 44H
Cursor Right	right arrow	1BH 43H
Field Advance	TAB	09H
Field Backspace	CTRL/TAB	1BH 0H
New Line	NEW LINE	0EH
Fast Left	N A.	N A.
Fast Right	N.A.	N.A.
<i>Special Control:</i>		
Error Reset	CTRL/R	12H
Insert Mode	INSERTCHAR or INSERT LINE	1BH 51H 1BH 4CH
Delete	DELETE CHAR or DELETE	1BH 50H 7FH
Erase Input	DELETE LINE or CTRL/E	1BH 4DH 05H
Home	HOME	1BH 68H
<i>Field Exit:</i>		
Duplicate	PF8	1BH 77H
Field Minus	PF7	1BH 76
Field Plus	PF5	1BH 74
Field Exit	PF6	1BH 75H

LINKUP 5294 WITH DL5294 FIRMWARE

5250 Function	Key Sequence	Hex Value Generated
<i>Aid Generating:</i>		
Enter	RETURN	0DH
Clear	ESC Z	1BH 5AH
Help	PF4	1BH 73H
Print	PF3	1BH 72H
Roll Up	ROLL UP	1BH 53H
Roll Down	ROLL DOWN	1BH 54H
CMD 1	ESC 1	1BH 31H
CMD 2	ESC 2	1BH 32H
CMD 3	ESC 3	1BH 33H
CMD 4	ESC 4	1BH 34H
CMD 5	ESC 5	1BH 35H
CMD 6	ESC 6	1BH 36H
CMD 7	ESC 7	1BH 37H
CMD 8	ESC 8	1BH 38H
CMD 9	ESC 9	1BH 39H
CMD 10	ESC 0	1BH 30H
CMD 11	ESC -	1BH 2DH
CMD 12	ESC =	1BH 3DH
CMD 13	ESC !	1BH 21H
CMD 14	ESC @	1BH 40H
CMD 15	ESC #	1BH 23H
CMD 16	ESC \$	1BH 24H
CMD 17	ESC %	1BH 25H
CMD 18	ESC ^	1BH 5EH
CMD 19	ESC &	1BH 26H
CMD 20	ESC *	1BH 2AH
CMD 21	ESC (1BH 28H
CMD 22	ESC)	1BH 29H
CMD 23	ESC _	1BH 5FH
CMD 24	ESC +	1BH 2BH
<i>Special Host:</i>		
System Request	PF1	1BH 70H
<i>Signal:</i>		
Attn	PF2	1BH 71H
<i>Extended Function:</i>		
Local Copy Print Req.	CTRL/P	10H
Local Copy Form Feed	ESC F	1BH 46H
Cancel Print	CTRL/K	0BH
Refresh Display	CTRL/W	17H
Toggle Status Line/ Toggle Indicators	CTRL/T	14H
Toggle Echoplex Enabled	CTRL/V	16H
Initialize Terminal	ESC <	1BH 3CH
Request Disconnect	ESC >	1BH 7EH

Hewlett Packard: HP-2645 Terminal Setup

1. Disconnect the AC power cord from the outlet before setting up the configuration switches.
2. There are three switches located at the upper left of the keyboard. These control the duplex, parity, and baud rate data communication options. Set the Duplex switch to FULL, and set the parity and baud as desired.
3. There are three groups of switches, with eight switches in each group, found on the 13260A Standard Asynchronous Communications PCA board within the terminal. Set these switches to the following values.

Switch	Set To:	Comments
A	OPEN	Transmit ESCAPE codes
B	CLOSED	Typed spaces will overwrite existing characters
C	OPEN	Auto wraparound disabled
D	N.A.	Applicable only in Block Mode
E	N.A.	Applicable only with paper-tape reading
F	CLOSED	Terminal Baud is determined by the switch on the keyboard
G, H, J, K	N.A.	Applicable only in Block Mode
L	CLOSED	No effect on Self-Test
M	CLOSED	INSERT CHAR and DELETE CHAR keys operate in normal sense
N	CLOSED	No effect on printer ESCAPE code transfer
P, Q	?	APL printing pairing codes
R	OPEN	Transition from receive state to transmit occurs after CB (Clear to Send) goes on.
S, T	CLOSED	Non-main channel protocol.
U, V	OPEN	Terminal ignores all transitions of SB (Secondary Receive Data) and CF (Carrier Detect)
W	?	Disable/Enable Data Comm. Self Test
X	?	Data Speed signal low or high (CH = 0 or 1)
Y	?	Transmit LED lit for CB (Send to Clear) or for CC (Data Set Ready)
Z	?	If Parity switch is set to No Parity, this switch forces Bit 8 to zero (CLOSED) or one (OPEN). If Parity switch is set to Even or Odd, this switch chooses Check for parity error (CLOSED) or No check for parity error (OPEN).

4. Replace the terminal cover, reconnect the AC power cord, and connect the terminal to the LinkUp 5294 with a modem or direct-connect cable, as appropriate.

F.14 HZ51 Terminal Module - Hazeltine 10/51

The following list identifies the key sequences defined for the HZSI Terminal Module.

1. Press <CTRL> concurrently with the indicated alpha key. CTRL is labeled as such on newer models of the terminal; on older models it is labeled PRINT, but it is still CTRL.
2. Press <ESC> prior to pressing the indicated alpha key.

5250 Function	Key Sequence	Hex Value Generated
---------------	--------------	---------------------

Cursor Movement:

Character Backspace	BACKSPACE	08H
Cursor Up	up arrow	1BH 0CH
Cursor Down	down arrow	1BH 0BH
Cursor Left	left arrow	1CH
Cursor Right	right arrow	10H
Field Advance	right arrow	09H
Field Backspace	left arrow	0FH
New Line	return key	0AH
Fast Left	N.A.	N.A.
Fast Right	N.A.	N.A.

Special Control:

Error Reset	ERROR RESET	03H
Insert Mode	INS	19H
Delete	DEL	7FH
Erase Input	ERASE INPUT	12H
Home	HOME	1BH 12H

Field Exit:

Duplicate	DUP	0EH
Field Minus	FIELD -	17H
Field Plus	FIELD +	1DH
Field Exit	FIELD EXIT	18H

Aid Generating:

Enter	ENTER	0DH
Clear	CMD SHIFT/	1BH 4DH
Help	HELP	1BH 7AH
Print	CTRL/HELP	1BH 56H
Roll Up	ROLL UP	1BH 55H
Roll Down	ROLL DOWN	1BH 52H
CMD 1	CMD 1	1BH 31H
CMD 2	CMD 2	1BH 32H
CMD 3	CMD 3	1BH 33H
CMD 4	CMD 4	1BH 34H
CMD 5	CMD 5	1BH 35H
CMD 6	CMD 6	1BH 36H
CMD 7	CMD 7	1BH 37H
CMD 8	CMD 8	1BH 38H
CMD 9	CMD 9	1BH 39H

APPENDIX F: Terminal Modules and ASCII Terminal Setups

5250 Function	Key Sequence	Hex Value Generated
CMD 10	CMD 0	1BH 30H
CMD 11	CMD-	1BH 2DH
CMD 12	CMD =	1BH 3DH
CMD 13	CMD]	1BH 5DH
CMD 14	CMD @	1BH 40H
CMD 15	CMD #	1BH 23H
CMD 16	CMD \$	1BH 24H
CMD 17	CMD %	1BH 25H
CMD 18	CMD ^	1BH 5EH
CMD 19	CMD &	1BH 26H
CMD 20	CMD *	1BH 2AH
CMD 21	CMD (1BH 28H
CMD 22	CMD)	1BH 29H
CMD 23	CMD _	1BH 5FH
CMD 24	CMD +	1BH 2BH

Special Host:

System Request	SYS REQ	1BH 3BH
----------------	---------	---------

Signal:

Attn	CMDA or ATTN	1BH 41H 00H
------	-----------------	----------------

Extended Function:

Local Copy Print Req.	ESC P	1BH 50H
Local Copy Form Feed	ESC F	1BH 46H
Cancel Print	CMD C	1BH 43H
Refresh Screen	CMD W	1BH 57H
Toggle Status Line/ Toggle Indicators	CMD T	1BH 54H
Toggle Echoplex Enabled	PRINT/V	16H
Initialize Terminal	CMD <	1BH 3CH
Request Disconnect	CMD >	1BH 3EH

Hazeltine: 10/51 Terminal Setup

NOTE

The auxiliary port on the 10/51 terminal can be used with the LinkUp 5294 Auxiliary Printer feature.

All operator-selected options are input from the keyboard into the Setup Mode Configuration screen; there are no external switches.

1. Call up the Configuration screen by pressing CTRL and CMD simultaneously. Set the option values as follows:

Option	Value/Comments
0	5251 Keyboard
1	CMD option on Altemate Keypad
2	ESC as lead-in character
3	Full Duplex
4	Character oriented attributcs
5	NO/Disable Auto Scroll
6	NO/Disable Auto New Line
7	?/Diagnostic Test
8	?/Cursor Block or Underline
9	?/50 Hz or 60Hz
A	?/Main Port Baud Rate
B	?/Auxiliary Port Baud Rate
C	?/Main Parity - EVEN, ODD, MARK, SPACE
D	?/Auxiliary Parity - EVEN, ODD, MARK, SPACE

F.15 IQ120 Terminal Module - Soroq IQ-120

The following list identifies the key sequences defined for the IQ120 Terminal Module.

1. Press <CTRL> concurrently with the indicated alpha key.
2. Press <ESC> prior to pressing the indicated alpha key.

5250 Function	Key Sequence	Hex Value Generated
<i>Cursor Movement:</i>		
Character Backspace	CTRL/C	03H
Cursor Up	CTRL/K	0BH
Cursor Down	LINE FEED or CTRL/J	0AH 09H
Cursor Left	CTRL/H	08H
Cursor Right	CTRL/L	0CH
Field Advance	CTRL/I or TAB	09H 09H
Field Backspace	CTRL/B	02H
New Line	CTRL/N	0EH
Fast Left	N.A.	N.A.
Fast Right	N.A.	N.A.
<i>Special Control:</i>		
Error Reset	CTRL/R	12H
Insert Mode	CTRL/U	15H
Delete	RUB	7FH
Erase Input	CTRL/E	05H
Home	HOME	1EH

APPENDIX F: Terminal Modules and ASCII Terminal Setups

5250 Function	Key Sequence	Hex Value Generated
---------------	--------------	---------------------

Field Exit:

Duplicate	CTRL/D	04H
Field Minus	CTRL/F	06H
Field Plus	N.A.	N.A.
Field Exit	CTRL/X	18H

Aid Generating:

Enter	RETURN	0DH
Clear	ESC Z	1BH 5AH
Help	ESCH	1BH 48H
Print	CTRL/P	10H
Roll Up	ESC U	1BH 55H
Roll Down	ESC D	1BH 44H
CMD 1	ESC 1	1BH 31H
CMD 2	ESC 2	1BH 32H
CMD 3	ESC 3	1BH 33H
CMD 4	ESC 4	1BH 34H
CMD 5	ESC 5	1BH 35H
CMD 6	ESC 6	1BH 36H
CMD 7	ESC 7	1BH 37H
CMD 8	ESC 8	1BH 38H
CMD 9	ESC 9	1BH 39H
CMD 10	ESC 0	1BH 30H
CMD 11	ESC -	1BH 2DH
CMD 12	ESC =	1BH 3DH
CMD 13	ESC !	1BH 21H
CMD 14	ESC @	1BH 40H
CMD 15	ESC #	1BH 23H
CMD 16	ESC \$	1BH 24H
CMD 17	ESC %	1BH 25H
CMD 18	ESC ^	1BH 5EH
CMD 19	ESC &	1BH 26H
CMD 20	ESC *	1BH 2AH
CMD 21	ESC (1BH 28H
CMD 22	ESC)	1BH 29H
CMD 23	ESC _	1BH 5FH
CMD24	ESC +	1BH 2BH

Special Host:

System Request	ESC S	1BH 52H
----------------	-------	---------

Signal:

Attn	ESC A	1BH 41H
------	-------	---------

5250 Function	Key Sequence	Hex Value Generated
<i>Extended Function:</i>		
Local Copy Print Req.	ESC P	1BH 50H
Local Copy Form Feed	ESC F	1BH 46H
Cancel Print	ESC C	1BH 43H
Refresh Screen	CTRL/W	17H
Toggle Status Line/ Toggle Indicator	ESC T	1BH 54H
Toggle Echoplex Enabled	CTRL/V	16H
Initialize Terminal	ESC <	1BH 3CH
Request Disconnect	ESC >	1BH 7EH

Soroc: IQ-120 Terminal Setup

1. Disconnect the AC power cord from the outlet before opening the IQ-120 case.
2. Manual controls are located on the rear of the IQ-120. Set the Block/Full/Half switch to FULL and the baud rate switch to the desired rate compatible with the LinkUp 5294.
3. Locate Switch C13 on the logic board of the terminal. These switches are used to specify the transmitted character format. Set these switches to correspond to the configuration parameters as follows:

SWITCH	DESCRIPTIONS	PORT	ON	OFF
1	Stop Bits	Printer	1	2
2	Parity	Printer	Yes	No
3	Parity	Printer	Odd	Even
4	Stop Bits	Main	1	2
5	Parity	Main	Yes	No
6	Bit Word	Main	7	8
7	Parity	Main	Odd	Evcn
8	Bit 8	Main	Low	High

When using auxiliary print, it is important to set the options for all devices and ports consistently.

4. Replace the cover on the terminal. Connect the terminal to the LinkUp 5294 with a modem or direct-connect cable, as appropriate.

NOTE

The auxiliary port of the IQ-120 terminal can be used with the LinkUp 5294 Auxiliary Printer facility.

F.16 I3101 Terminal Module - IBM 3101

The following list identifies the key sequences defined for the I3101 Terminal Module.

1. Press <ALT> concurrently with the indicated alpha key.
2. Press <ESC> prior to pressing the indicated alpha key.

5250 Function	Key Sequence	Hex Value Generated
<i>Cursor Movement:</i>		
Character Backspace	ALT/C	03H
Cursor Up	up arrow	1BH 41H
Cursor Down	down arrow	1BH 42H
Cursor Left	left arrow	1BH 44H
Cursor Right	right arrow	1BH 43H
Field Advance	right arrow	09H
Field Backspace	left arrow	08H
New Line	ALT/N	0EH
Fast Left	N.A.	N.A.
Fast Right	N.A.	N.A.
<i>Special Control:</i>		
Error Reset	ALT/R	12H
Insert Mode	ALT/U	15H
Delete	DEL	7FH
Erase Input	ERASE INPUT	1BH 4BH
Home	HOME SYMBOL	1BH 48H
<i>Field Exit:</i>		
Duplicate	PF8	1BH 68H 0DH
Field Minus	PF6	1BH 66H 0DH
Field Plus	PF3	1BH 63H 0DH
Field Exit	PF7	1BH 67H 0DH
<i>Aid Generating:</i>		
Enter	left arrow	0DH
Clear	CLEAR	1BH 4CH
Help	PF5	1BH 65H 0DH
Print	PF4	1BH 64H 0DH
Roll Up	PF1	1BH 61H 0DH
Roll Down	PF2	1BH 62H 0DH
CMD 1	ESC 1	1BH 31H
CMD 2	ESC 2	1BH 32H
CMD 3	ESC 3	1BH 33H
CMD 4	ESC 4	1BH 34H
CMD 5	ESC 5	1BH 35H
CMD 6	ESC 6	1BH 36H
CMD 7	ESC 7	1BH 37H
CMD 8	ESC 8	1BH 38H
CMD 9	ESC 9	1BH 39H
CMD 10	ESC 0	1BH 30H

LINKUP 5294 WITH DL5294 FIRMWARE

5250 Function	Key Sequence	Hex Value Generated
CMD 11	ESC -	1BH 2DH
CMD 12	ESC =	1BH 3DH
CMD 13	ESC !	1BH 21H
CMD 14	ESC @	1BH 40H
CMD 15	ESC #	1BH 23H
CMD 16	ESC \$	1BH 24H
CMD 17	ESC %	1BH 25H
CMD 18	ESC ^	1BH 5EH
CMD 19	ESC &	1BH 26H
CMD 20	ESC *	1BH 2AH
CMD 21	ESC (1BH 28H
CMD 22	ESC)	1BH 29H
CMD 23	ESC _	1BH 5FH
CMD 24	ESC +	1BH 2BH

Special Host:

System Request	ERASE EOL/EOF	1BH 49H
----------------	---------------	---------

Signal:

Attn	ERASE EOS	1BH 4AH
------	-----------	---------

Extended Function:

Local Copy Print Req.	ESC P	1BH 50H
Local Copy Form Feed	ESC F	1BH 46H
Cancel Print	ALT/K	08H
Refresh Display	ALT/V	17H
Toggle Status Line/ Toggle Indicators	ESC T	1BH 54H
Toggle Echoplex Enabled	ALT/V	16H
Initialize Terminal	ESC <	1BH 3CH
Request Disconnect	ESC >	1BH 3EH

IBM: 3101 Terminal Setup

NOTE

The auxiliary port on the 3101 terminal cannot be used with the LinkUp 5294 Auxiliary Printer facility.

1. Disconnect the AC Power cord from the outlet before starting the setup process.
2. There are 8 toggle-type switches located on the keyboard as Group 1 switches. These switches control the communications connect options and are set to the following values:

Group 1 Switches	Set To:	Comments
CHAR-BLOCK	CHAR	Selects TTY-compatible character interfaces
FDX-HDX	FDX	Full-duplex operations enabled
CL422-232C	232C	Sets EIA RS-232 option
CRTS-PRTS	PRTS	RTS held continuously high
REV CHAN	REV CHAN	Operations enabled without reverse channel
ON-OFF	OFF	

Group 1 Switches	Set To:	Comments
LINE TURN AROUND CHARS (Sw 6 - 7)	CR	Set Sw 6 = 0, Sw 7 = 1
MONO-DUAL	DUAL	Sets dual-case character set

3. There are 8 toggle switches located on the keyboard element as GROUP 2 switches. These switches describe the terminal operating characteristics and are set to the following values:

Group 2 Switches	Set To:	Comments
STOP1-STOP2, STOP 1		Set to 1 stop bit unless 110-baud rate is desired. For 110 baud, use STOP2.
PARITY	SPACE	Sw2 = 0, Sw3 = 0
	MARK	Sw2 = 0, Sw3 = 1
	ODD	Sw2 = 1, Sw3 = 0
	EVEN	Sw2 = 1, Sw3 = 1
		Set switches to desired parity
SEND LINE OPTION	OFF	Sets normal send function
NULL SUPPRESSION	OFF	All nulls are not suppressed
TIME FILL CHARS	0	No time fill characters; set Sw7 (Sw 7-8) = 0, Sw8 = 0

4. There are 8 toggle switches located on the keyboard element as GROUP 3 switches. These switches describe the functional terminal operating characteristics and are set to the following values:

Group 3 Switches	Set To:	Comments
AUTO NL ON-OFF	OFF	Automatic generation of New Line disabled
AUTO LF ON-OFF	OFF	Automatic generation of line feed disabled
CR/CR-LF	CR	Disable automatic generation of a line-feed character every time a carriage return is keyed
SCROLL ON-OFF	OFF	Scrolling disabled
REVERSE VIDEO ON-OFF	?	Video capability is set as is desired
BLINK CURSOR ON-OFF	?	Cursor is set as desired

5. There are 8 toggle-type switches located on the keyboard element as GROUP 4 switches. These switches describe the baud rates needed for both primary and auxiliary communication interfaces. The list on the next page describes how to set the desired baud rate.

I/O BAUD RATE	SWITCHES			
	1	2	3	4
110	OFF	OFF	OFF	OFF
150	OFF	OFF	OFF	ON
200	OFF	OFF	ON	OFF
300	OFF	OFF	ON	ON
600	OFF	ON	OFF	OFF
1200	OFF	ON	OFF	ON
1800	OFF	ON	ON	OFF
2400	OFF	ON	ON	ON
4800	ON	OFF	OFF	OFF
9600	ON	OFF	OFF	ON

The baud rate set into the above switches must match the baud rate specified for the converter port to which this terminal is to be connected. If a baud rate of 110 is selected, be sure the number of stop bits is 2. (See STOP 2 switch specified in the GROUP 2 Switches.)

6. Reconnect the AC power cord and connect the terminal to the converter with a modem or direct-connect cable, as appropriate.

F.17 I3151 Terminal Module — IBM 3151

The following list identifies the key sequences defined for the I3151 Terminal Module.

1. Press <CTRL> concurrently with the indicated alpha key.
2. Press the <ESC> key prior to pressing the indicated alpha key.

5250 Function	Key Sequence	Hex Value Generated
<i>Cursor Movement:</i>		
Character Backspace	BACKSPACE	08H
Cursor Up	up arrow	1BH 41H
Cursor Down	down arrow	1BH 42H
Cursor Left	left arrow	1BH 44H
Cursor Right	right arrow	1BH 43H
Field Advance	TAB	09H
Field Backspace	BACKTAB or SHIFT/TAB	1BH 32H 1BH 32H
New Line	CTRL/DELTE	1BH 4FH
Fast Left	CTRL/Z or CTRL/NK 1	1AH 1BH 21H 6DH 0DH
FastRight	CTRL/X or CTRL/NK 2	18H 1BH 21H 6EH 0DH

Special Control:

Error Resct	CTRL/R or NKJUMP	12H 1BH 22H 41H
Insert Mode	INSERT	1BH 50H 20H 08H
Delete	DELETE	1BH 51H
Erase I nput	CTRL/CLEAR	1BH 4BH
Home	HOME	1BH 48H

APPENDIX F: Terminal Modules and ASCII Terminal Setups

5250 Function	Key Sequence	Hex Value Generated
<i>Field Exit:</i>		
Duplicate	CTRL/SHIFT/F2	1BH 22H 62H 0DH
Field Minus	NK SEND LINE	1BH 21H 38H 0DH
Field Plus	RETURN	0DH
	or NK ENTER	0DH
Field Exit	CTRL/RETURN	0AH
<i>Aid</i>		
Enter	SEND	1BH 38H 0DH
Clear	CTRL/ERASE EOT	1BH 4AH
Help	CTRL/SHIFT/F5	1BH 22H 65H 0DH
Print	CTRL/SHIFT/F10	1BH 22H 6AH 0DH
Roll Up	CLEAR	1BH 4BH 0DH
Roll Down	ERASE EOT	1BH 49H
CMD 1	F1	1BH 61H 0DH
CMD 2	F2	1BH 62H 0DH
CMD 3	F3	1BH 63H 0DH
CMD 4	F4	1BH 64H 0DH
CMD 5	F5	1BH 65H 0DH
CMD 6	F6	1BH 66H 0DH
CMD 7	F7	1BH 67H 0DH
CMD 8	F8	1BH 68H 0DH
CMD 9	F9	1BH 69H 0DH
CMD 10	F10	1BH 6AH 0DH
CMD 11	F11	1BH 6BH 0DH
CMD 12	F12	1BH 6CH 0DH
CMD 13	SHIFT/F1	1BH 22H 61H 0DH
CMD 14	SHIFT/F2	1BH 22H 62H 0DH
CMD 15	SHIFT/F3	1BH 22H 63H 0DH
CMD 16	SHIFT/F4	1BH 22H 64H 0DH
CMD 17	SHIFT/F5	1BH 22H 65H 0DH
CMD 18	SHIFT/F6	1BH 22H 66H 0DH
CMD 19	SHIFT/F7	1BH 22H 67H 0DH
CMD 20	SHIFT/F8	1BH 22H 68H 0DH
CMD 21	SHIFT/F9	1BH 22H 69H 0DH
CMD 22	SHIFT/F10	1BH 22H 6AH 0DH
CMD 23	SHIFT/F11	1BH 22H 6BH 0DH
CMD 24	SHIFT/F12	1BH 22H 6CH 0DH
<i>Special Host</i>		
System Request	CTRL/SHIFT/F8	1BH 22H 68H 0DH
<i>Signal:</i>		
Attn	CTRL/SHIFT/F1	1BH 22H 61H 0DH

5250 Function	Key Sequence	Hex Value Generated
<i>Special Function:</i>		
Cancel Print	CTRL/SHIFT/F11	1BH 22H 6BH 0DH
Refresh Display	CTRL/W or CTRL/SHIFT/F6	17H 1BH 22H 46H 0DH
Initialize Terminal	ESC <	1BH 3CH
Toggle Indicators	ESC T or CTRL/SHIFT/F7	1BH 54H 1BH 22H 47H 0DH
Request Disconnect	ESC >	1BH 3EH

IBM 3151 Terminal Setup

All operator-selectable options are input from the keyboard into the Setup and Select menus. There are no external switches.

1. Enter the Setup Menu by depressing the Setup key (CTRL and SELECT). Change menus with the SEND key. Options marked with (*) will be automatically set/overridden after entry into emulation mode. Set the options as follows:

General Menu

Parameter	Set To:	Comments
Machine Mode	IBM 3151	For 3151 operation
Screen	As desired	NORMAL (*) or REVERSE
Row and Column	24 x 80 (*)	
Scroll	NO (*)	Auto scroll is disabled
Auto LF	OFF (*)	Upon receipt of a CR, only a carriage return (and not a carriage return, line feed) is performed by the terminal
CRT Saver	ON (*)	
Line Wrap	OFF (*)	Auto Line Wrap is disabled
Forcing Insert	OFF (*)	
Tab	As desired	Field or Column. Overridden by the converter.

Communication Menu

Parameter	Set To:	Comments
Operating Mode	ECHO	ECHO (conversational) mode, with the converter handling the echo of the keyboard input
Line Speed	As desired	Main/Aux. port baud rates (110-19200 bits per sec.)
Word Length	As desired	Main/Aux. ports (7 or 8 bits)
Parity	As desired	Main/Aux. ports (Space, Mark, Odd, Even, or None)
Stop Bit	As desired	Main/Aux. ports (1 or 2 bits)
Turnaround Character	CR	Line turnaround character to be sent at the end of a Send or Function key sequence or upon reception of a "read type" command
Interface	RS-232C	EIA RS-232C interface
Line Control	As desired (see note 3)	PRTS-permanent RTS (*) CRTS-controlled RT IPRTS-induced permanent RTS
Break Signal	As desired	170 or 500 msec (*)
Set Null Suppress	As desired	ON or OFF (*)

Keyboard/Printer Menu

Parameter	Set to:	Comments
Enter	As desired	When set to RETURN (*) will cause numeric keypad ENTER to work as Field+ key. When set to SEND, numeric keypad key will work as Enter/Record Advance has to be done every time after entering emulation key.
Return	NEW LINE (*)	
New Line	CR	Return/Enter keys generate CR character (*)
Send	PAGE	Selects code for Send key
Insert Character	SPACE (*)	MODE setting disabled INSERT key

Printer options should be set as appropriate for an auxiliary printer.

1. The port on the rear of the IBM 3151 farthest from the power cord is the standard EIA interface (main port).
2. The other port on the rear of the IBM 3151 is used for the Auxiliary Printer feature. For a description of this feature, see the appropriate User's Guide.
3. The pacing function (flow control) on the IBM 3151 main port is performed only when the communication parameter, Line Control, is set to either PRTS or IPRTS. The flow control options on the LinkUp 5294 should be set to XON.

F.18 I3161 Terminal Module - IBM 3161/3163

The following list identifies the key sequences defined for the I3161 Terminal Module.

1. Press <CTRL> concurrently with the indicated alpha key.
2. Press <ESC> prior to pressing the indicated alpha key.

5250 Function	Key Sequence	Hex Value Generated
<i>Cursor Movement:</i>		
Character Backspace	BACKSPACE	08H
Cursor Up	up arrow	1BH 41H
Cursor Down	down arrow	1BH 42H
Cursor Left	left arrow	1BH 44H
Cursor Right	right arrow	1BH 43H
Field Advance	TAB	09H
Field Backspace	BACKTAB	1BH 32H
New Line	LINE FEED	0AH
Fast Left	N.A.	N.A.
Fast Right	N.A.	N.A.
<i>Special Control:</i>		
Error Reset	CTRL/R or F12 or SHIFT/F12	12H 1BH 6CH 0DH 1BH 21H 6CH 0DH
Insert Mode	INS LN or F3	1BH 4EH 1BH 63H 0DH

LINKUP 5294 WITH DL5294 FIRMWARE

5250 Function	Key Sequence	Hex Value Generated
Delete	DEL or SHIFT/F3 or DELETE	7FH 1BH 21H 63H 0DH 1BH 51H
Erase Input	SHIFT/F4 or ER NP	1BH 21H 64H 0DH 1BH 4BH
Home	F4 or HOME	1BH 64H 0DH 1BH 48H
<i>Field Exit:</i>		
Duplicate	F11 or SHIFT/F11	1BH 6BH 0DH 1BH 21H 6BH 0DH
Field Minus	F10 or SHIFT/F10	1BH 6AH 0DH 1BH 21H 6A 0DH
Field Plus	F9 or SHIFT/F9	1BH 69H 0DH 1BH 21H 69H 0DH
Field Exit	RETURN	0DH
<i>Aid Generating:</i>		
Enter	NK ENTER or SEND	1BH 38H 0DH
Clear	CLEAR	1BH 4CH 0DH
Help	F6	1BH 66H 0DH
Print	F5	1BH 65H 0DH
Roll Up	F7 or SHIFT/F7	1BH 67H 0DH 1BH 21H 67H 0DH
Roll Down	F8 or SHIFT/F8	1BH 68H 0DH 1BH 21H 68H 0DH
CMD	F2 or SHIFT F2	1BH 62H 0DH 1BH 21H 62H 0DH
CMD 1	F2 1	1BH 62H 0DH 31H
CMD 2	F2 2	1BH 62H 0DH 32H
CMD 3	F2 3	1BH 62H 0DH 33H
CMD 4	F2 4	1BH 62H 0DH 34H
CMD 5	F2 5	1BH 62H 0DH 35H
CMD 6	F2 6	1BH 62H 0DH 36H
CMD 7	F2 7	1BH 62H 0DH 37H
CMD 8	F2 8	1BH 62H 0DH 38H
CMD 9	F2 9	1BH 62H 0DH 39H
CMD 10	F2 0	1BH 62H 0DH 30H
CMD 11	F2 -	1BH 62H 0DH 2DH
CMD 12	F2 =	1BH 62H 0DH 3DH
CMD 13	F2 !	1BH 62H 0DH 21H
CMD 14	F2 @	1BH 62H 0DH 40H
CMD 15	F2 #	1BH 62H 0DH 23H
CMD 16	F2 \$	1BH 62H 0DH 24H
CMD 17	F2 %	1BH 62H 0DH 25H
CMD 18	F2 ^	1BH 62H 0DH SEH
CMD 19	F2 &	1BH 62H 0DH 26H
CMD 20	F2 *	1BH 62H 0DH 2AH
CMD 21	F2 (1BH 62H 0DH 28H
CMD 22	F2)	1BH 62H 0DH 29H

APPENDIX F: Terminal Modules and ASCII Terminal Setups

5250 Function	Key Sequence	Hex Value Generated
CMD 23	F2_ (underline)	1BH 62H 0DH 5FH
CMD 24	F2 +	1BH 62H 0DH 2BH
<i>Special Host:</i>		
System Request	SHIFT/F1	1BH 21H 61H 0DH
<i>Signal:</i>		
Attn	F1	1BH 61H 0DH
<i>Extended Function:</i>		
Local Copy Print Req. CTRL/P		10H
Local Copy Form Feed	ESC I	1BH 7CH
Cancel Print	SHIFT/F5	1BH 21H 65H 0DH
Refresh Display	CTRL/W	17H
Toggle Status Line/ Toggle Indicators	ESC T	1BH 54H
Toggle Echoplex Enabled	CTRL/V	16H
Initialize Terminal	ESC <	1BH 3CH
Request Disconnect	ESC >	1BH 7EH

IBM: 3161 and 3163 Terminal Setups

All operator-selected options are input from the keyboard into the Setup and Select menus. There are no external switches.

1. Enter the Setup Menu by pressing <CTRL> and <SELECT>. Set the options as follows:

Parameter Menu	Set To:	Comments
Machine Mode	IBM 3161/3163	For 3161/3163 operation
Operating Mode	ECHO	ECHO (conversational) mode, with LinkUp 5294 handling the echo of the keyboard input
Interface	RS-232C	EIA RS-232 interface
Line Control	As desired	PRTS-permanent RTS CRTS-controlled RTS IPRTS-induced permanent RTS
Line Speed	As desired	Main/Aux. port baud rates (110–19200 bits per sec.)
Parity	As desired	Main/Aux ports (Space, Mark Odd, Even, or None)
Turnaround Character	CR	Line turnaround character to be sent at the end of a read-type command
Stop Bit	As desired	Main/Aux ports (1 or 2 bits)
Word Length	As desired	Main/Aux ports (7 or 8 bits)
Response Delay	As desired	0 or 100 msec.
Break Signal	As desired	170 or 500 msec.

2. Enter the Select Menu by pressing <SELECT>. Set the options as follows:

Parameter Menu	Set To:	Comments
Enter	SEND	Enter key acts as a "Send" key
Return	NEW LINE	New Line occurs when the Return Key is pressed
New Line	CR	Return/Enter keys generate CR character
Tab	As desired	Field or Column. Overridden by the LinkUp 5294
Line Wrap	OFF	Auto Line Wrap is disabled
Auto LF	OFF	After receiving a <CR>, only a carriage return (and not a carriage return, line feed) is performed by the terminal
Send	N.A.	Not applicable in Echo Mode
Send Null	N.A.	Not applicable in Echo Mode
Insert	N.A.	Not applicable; the Insert key is not used
Trace	N.A.	Not applicable; as it does not affect communication to the LinkUp 5294
CRT Saver	N.A.	Overridden by the LinkUp 5294
Scroll	OFF	Auto scroll is disabled
Print	N.A.	Not applicable; the Print key is not used
Print EOL	OFF	No end-of-line character sent to the printer by the terminal
Line End	N.A.	Not applicable; the Print EOL option is disabled.

1. The port labeled 2 on the rear of the IBM 3161 is the standard EIA interface (main port).

2. The port labeled 1 on the rear of the 3161 can be used with the LinkUp Auxiliary Printer facility.

F.19 I3164 Terminal Module - IBM 3164

The following list identifies the key sequences defined for the B164 Terminal Module.

1. Press <CTRL> concurrently with the indicated alpha key.

2. Press <ESC> prior to pressing the indicated alpha key.

5250 Function	Key Sequence	Hex Value Generated
<i>Cursor Movement:</i>		
Character Backspace	BACKSPACE	08H
CursorUp	up arrow	1BH 41H
Cursor Down	down arrow	1BH 42H
Cursor Left	left arrow	1BH 44H
Cursor Right	right arrow	1BH 43H
Field Advance	TAB	09H
Field Backspace	BACKTAB	1BH 32H
New Line	CTRL/DELETE	1BH 4FH
Fast Left	CTRL/left arrow	1BH 20H 44H
Fast Right	CTRL/right arrow	1BH 20H 43H
<i>Special Control:</i>		
Error Reset	CTRL/R or NKJUMP	12H 1BH 22H 41H

APPENDIX F: Terminal Modules and ASCII Terminal Setups

5250 Function	Key Sequence	Hex Value Generated
Insert Mode	INSERT	1BH 50H 20H 08H
Delete	DELETE	1BH 51H
Erase Input	CTRL/CLEAR	1BH 4BH
Home	HOME	1BH 48H
<i>Field Exit:</i>		
Duplicate	CTRL/D	04H
Field Minus	NK SEND KEY	1BH 21H 38H 0DH
Field Plus	RETURN or NK ENTER	0DH
Field Exit	CTRL/RETURN	0AH
<i>Aid Generating:</i>		
Enter	SEND	1BH 38H 0DH
Clear	CTRL/ERASE EOF	1BH 4AH
Help	PAGE	1BH 21H 41H
Print	PRINT	7FH
Roll Up	CLEAR	1BH 4CH 0DH
Roll Down	ERASE EOF	1BH 49H
CMD 1	F1	1BH 61H 0DH
CMD 2	F2	1BH 62H 0DH
CMD 3	F3	1BH 63H 0DH
CMD 4	F4	1BH 64H 0DH
CMD 5	F5	1BH 65H 0DH
CMD 6	F6	1BH 66H 0DH
CMD 7	F7	1BH 67H 0DH
CMD 8	F8	1BH 68H 0DH
CMD 9	F9	1BH 69H 0DH
CMD 10	F10	1BH 6AH 0DH
CMD 11	F11	1BH 6BH 0DH
CMD 12	F12	1BH 6CH 0DH
CMD 13	SHIFT/F1	1BH 21H 61H 0DH
CMD 14	SHIPT/F2	1BH 21H 62H 0DH
CMD 15	SHIPT/F3	1BH 21H 63H 0DH
CMD 16	SHIFT/F4	1BH 21H 64H 0DH
CMD 17	SHIFT/F5	1BH 21H 65H 0DH
CMD 18	SHIFT/F6	1BH 21H 66H 0DH
CMD 19	SHIFT/F7	1BH 21H 67H 0DH
CMD 20	SHIFT/F8	1BH 21H 68H 0DH
CMD 21	SHIFT/F9	1BH 21H 69H 0DH
CMD 22	SHIFT/F10	1BH 21H 6AH 0DH
CMD 23	SHIFT/F11	1BH 21H 6BH 0DH
CMD 24	SHIFT/F12	1BH 21H 6CH 0DH
<i>Special Host:</i>		
System Request	CTRL/SEND LINE	1BH 20H 38H 0DH
<i>Signal:</i>		
Attn	CTRL/A	01H

LINKUP 5294 WITH DL5294 FIRMWARE

5250 Function	Key Sequence	Hex Value Generated
<i>Extended Function:</i>		
Local Copy Print Req.	CTRL/P	10H
Local Copy Form Feed	ESC !	1BH 7CH
Cancel Print	ESC Z	1BH 5AH
Refresh Display	CTRL/W	17H
Toggle Status Line/ Toggle Indicators	ESC T	1BH 54H
Toggle Echoplex Enabled	CTRL/V	16H
Initialize Terminal	ESC <	1BH 3CH
Request Disconnect	ESC >	1BH 7EH

IBM: 3164 Terminal Setups

1. Enter the Setup Menu by pressing <CTRL> and <SELECT>. Set the options as follows:

Parameter Menu	Set To:	Comments
Machine Mode	IBM 3164	For 3164 operation
Operating Mode	ECHO	ECHO (conversational) mode, with LinkUp 5294 handling the echo of the keyboard input
Interface	RS-232C	EIA RS-232 interface
Line Control	As desired	PRTS-permanent RTS CRTS-controlled RTS IPRTS-induced permanent RTS
Line Speed	As desired	Main/Aux. port baud rates (110-19200 bits per sec.)
Parity	As desired	Main/Aux. ports (Space, Mark Odd, Even, or None)
Turnaround Character	CR	Line turnaround character to be sent at the end of a read-type command
Stop Bit	As desired	Main/Aux ports (1 or 2 bits)
Word Length	As desired	Main/Aux ports (7 or 8 bits)
Response Delay	As desired	0 or 100 msec.
Break Signal	As desired	170 or 500 msec.

2. Enter the Select Menu by pressing <SELECT>. Set the options as follows:

Parameter Menu	Set To:	Comments
Enter	SEND	Enter key acts as a "Send" key
Return	NEW LINE	New Line occurs when the Return Key is pressed
New Line	CR	Return/Enter keys generate CR character
Tab	As desired	Field or Column. Overridden by the LinkUp 5294
Line Wrap	OFF	Auto Line Wrap is disabled
Auto LF	OFF	After receiving a <CR>, only a carriage return (and not a carriage return, line feed) is performed by the terminal
Send	N.A.	Not applicable in Echo Mode
Send Null	N.A.	Not applicable in Echo Mode
Insert	N.A.	Not applicable; the Insert key is not used
Trace	N.A.	Not applicable; as it does not affect communication to the LinkUp 5294
CRT Saver	N.A.	Overridden by the LinkUp 5294
Scroll	OFF	Auto scroll is disabled

Parameter Name:	Set To:	Comments
Print	N.A.	Not applicable; the Print key is not used
Print EOL	OFF	No end-of-line character sent to the printer by the terminal
Line End	N.A.	Not applicable; the Print EOL option is disabled.

1. The port labeled 2 on the rear of the IBM 3161 is the standard EIA interface (main port).
2. The port labeled 1 on the rear of the 3161 can be used with the LinkUp Auxiliary Printer facility.

F.20 REBUS 3000 Terminal Module - Rebus 3000

The following list identifies the key sequences defined for the REBUS 3000 Terminal Module.

1. Press <CTRL> concurrently with the indicated alpha key.
2. Press <ESC> prior to pressing the indicated alpha key.

5250 Function	Key Sequence	Hex Value Generated
<i>Cursor Movement:</i>		
Character Backspace	BACKSPACE	08H
Cursor Up	up arrow or ESC A	1BH 5BH 41H 1BH 41H
Cursor Down	down arrow or ESC B	1BH 5BH 42H 1BH 42H
Cursor Left	left arrow or ESC D	1BH 5BH 44H 1BH 44H
Cursor Right	right arrow or ESC C	1BH 5BH 43H 1BH 43H
Field Advance	TAB	09H
Field Backspace	BACKTAB ESC I	1BH 31H 1BH 49H
New Line	NEW LINE	1BH 34H
Fast Left	ALT/left arrow	18H 1BH 44H
Fast Right	ALT/right arrow	18H 1BH 43H
<i>Special Control:</i>		
Error Reset	RESET/CANCEL	1BH 51H
Insert Mode	INS	1BH 35H
Delete	DEL	1BH 36H
Erase Input	ERASE INPUT	1BH 56H
Home	HOME SYMBOL	1BH 48H
<i>Field Exit</i>		
Duplicate	DUP	1BH 32H
Field Minus	FIELD -	1BH 52H
Field Plus	FIELD+	1BH 4FH
Field Exit	(RETURN)	0DH

LINKUP 5294 WITH DL5294 FIRMWARE

5250 Function	Key Sequence	Hex Value Generated
<i>Aid Generating:</i>		
Enter	LINE FEED	0AH
Clear	ALT/CLEAR	18H 7FH
Help	HELP	1BH 46H
Print	PRINT	1BH 45H
Roll Up	ROLL up arrow	1CH 41H
Roll Down	ROLL down arrow	1CH 42H
CMD 1	CMD 1	1BH 19H 31H
CMD 2	CMD 2	1BH 19H 32H
CMD 3	CMD 3	1BH 19H 33H
CMD 4	CMD 4	1BH 19H 34H
CMD 5	CMD 5	1BH 19H 35H
CMD 6	CMD 6	1BH 19H 36H
CMD 7	CMD 7	1BH 19H 37H
CMD 8	CMD 8	1BH 19H 38H
CMD 9	CMD 9	1BH 19H 39H
CMD 10	CMD 10	1BH 19H 30H
CMD 11	CMD 11	1BH 19H 2DH
CMD 12	CMD 12	1BH 19H 3DH
CMD 13	CMD 13	1BH 19H 5DH
CMD 14	CMD 14	1BH 19H 40H
CMD 15	CMD 15	1BH 19H 23H
CMD 16	CMD 16	1BH 19H 24H
CMD 17	CMD 17	1BH 19H 25H
CMD 18	CMD 18	1BH 19H SEH
CMD 19	CMD 19	1BH 19H 26H
CMD 20	CMD 20	1BH 19H 2AH
CMD 21	CMD 21	1BH 19H 28H
CMD 22	CMD 22	1BH 19H 29H
CMD 23	CMD 23	1BH 19H 5FH
CMD 24	CMD 24	1BH 19H 2BH
<i>Special Host:</i>		
System Request	SYS REQ	1CH 53H
<i>Signal:</i>		
Attn	ATTN	1BH 53H
<i>Extended Function:</i>		
Local Copy Print Req.	N.A.	N.A.
Local Copy Form Feed	N.A.	N.A.
Cancel Print	SHIFT/PRINT	1CH 45H
Refresh Screen	ESC W	1BH 57H
Toggle Status Line/ Toggle Indicators	ESC T	1BH 54H
Toggle Echoplex Enabled	CTRL/V	16H
Initialize Terminal	ESC <	1BH 3CH
Request Disconnect	ESC >	1BH 3EH

REBUS: REBUS 3000 Terminal Setup

To enter Setup mode on the Rebus 3000 terminal, power on the terminal, then press SHIFT and SET UP simultaneously, release, and press TAB. Parameter options and features are displayed along the bottom of the screen. (Refer to the terminal operator's guide for details on use of SETUP mode.) Select the following settings for each of the Setup options:

Group	Setting
DISPLAY	
80 Columns	
Interpreter Controls	
CRT-Saver	As desired
Cursor	As desired
Light Text, Dark Screen	
No Autowrap	
GENERAL	
VT200, 7-bit Controls	
User-defined Keys Unlocked	
User Features Unlocked	
Clear User defined Keys	
No New Line	
Multinational	
COMMUNICATIONS	
Speed	User (as desired)
XOFF/DTR	User (as desired)
Bits, Parity	User (as desired)
Stop Bit	User (as desired)
No Local Echo	
Main Port Data Leads Only	
Disconnect Delay	User (as desired)
Limited/Unlimited Transmit	User (as desired)
PRINTER	
Speed	User (as desired)
Print Mode	User (as desired)
Bits, Parity	User (as desired)
Stop Bit	User (as desired)
Print Full Page	User (as desired)
Print (Multi) National	User (as desired)
No Terminator	User (as desired)
KEYBOARD	
Auto Repeat	User (as desired)
Key Click	User (as desired)
Margin Bell	User (as desired)
Warning Bell	User (as desired)
No Auto-Answerback	
Answerback Message	N.A.
Answerback Concealed	N.A.

Group	Setting
TABS	N A.
ENHANCEMENTS	
Main Received XON	User (as desired)
Rapid Mode: Disabled	
Space Suppression	N.A.
Transmit Area	N.A.
Transmit Execution	N.A.
DISPLAY FORMAT	
Setup Directory	
Main Online	N.A.
Clear Display	N.A.
Clear Comm	N.A.
Reset Terminal	N.A.
Recall	N.A.
Save	N.A.
Language	N.A.
Keyboard	User (as desired)
Default	N.A.
Program Keys	User (as desired)
80 Columns	
Refresh Rate	User (as desired)
24 Data & Information Line	

F.21 SCANS Terminal Module - Tymshare Scanset

The following list identifies the key sequences defined for the SCANS Terminal Module.

1. Press <CTRL> concurrently with the indicated alpha key.
2. Press <ESC> prior to pressing the indicated alpha key.
3. The last position of the screen (Row 24, Column 80) is designed not to display a character. This prevents automatic scrolling.

5250 Function	Key Sequence	Hex Value Generated
<i>Cursor Movement</i>		
Character Backspace	CTRL/C	03H
Cursor Up	up arrow	1BH 41H
Cursor Down	down arrow	1BH 42H
Cursor Left	left arrow	1BH 44H
Cursor Right	right arrow	1BH 43H
Field Advance	CTRL/A	01H
Field Backspace	CTRL/B	02H
New Line	CTRL/J	0AH
Fast Left	N A.	N.A.
Fast Right	N.A.	N.A.

APPENDIX F: Terminal Modules and ASCII Terminal Setups

5250 Function	Key Sequence	Hex Value Generated
<i>Special Control:</i>		
Error Reset	CTRL/R	12H
Insert Mode	CTRL/U	15H
Delete	DEL	7FH
Erase Input	CTRL/E	05H
Home	CTRL/^	1EH
<i>Field Exit:</i>		
Duplicate	CTRL/D	04H
Field Minus	CTRL./F	06H
Field Plus	N.A.	N.A.
Field Exit	CTRL/X	18H
<i>Aid Generating:</i>		
Enter	ENTER	0DH
Clear	ESC J	1BH 4AH
Help	ESC H	1BH 48H
Print	CTRL/P	10H
Roll Up	ESC U	1BH 55H
Roll Down	ESC R	1BH 52H
CMD 1	ESC 1	1BH 31H
CMD 2	ESC 2	1BH 32H
CMD 3	ESC 3	1BH 33H
CMD 4	ESC 4	1BH 34H
CMD 5	ESC 5	1BH 35H
CMD 6	ESC 6	1BH 36H
CMD 7	ESC 7	1BH 37H
CMD 8	ESC 8	1BH 38H
CMD 9	ESC 9	1BH 39H
CMD 10	ESC 0	1BH 30H
CMD 11	ESC -	1BH 2DH
CMD 12	ESC =	1BH 3DH
CMD 13	ESC !	1BH 21H
CMD 14	ESC @	1BH 40H
CMD 15	ESC #	1BH 23H
CMD 16	ESC \$	1BH 24H
CMD 17	ESC %	1BH 25H
CMD 18	ESC ^	1BH 5EH
CMD 19	ESC &	1BH 26H
CMD 20	ESC *	1BH 2AH
CMD 21	ESC (1BH 28H
CMD 22	ESC)	1BH 29H
CMD 23	ESC _	1BH 5FH
CMD 24	ESC +	1BH 2BH
<i>Special Host</i>		
System Request	ESC S	1BH 53H

5250 Function	Key Sequence	Hex Value Generated
<i>Signal:</i>		
Attn	ESC E	1BH 45H
<i>Extended Function:</i>		
Local Copy Print Req.	ESC P	1BH 50H
Local Copy Form Feed	ESC F	1BH 46H
Cancel Print	ESC X	1BH 58H
Refresh Screen	CTRL/W	17H
Toggle Status Line/ Toggle Indicators	ESC T	1BH 54H
Toggle Echoplex Enabled	CTRL/V	16H
Initialize Terminal	ESC <	1BH 3CH
Request Disconnect	ESC >	1BH 3EH

TYMSHARE: Scanset Terminal Setup

All parameters of the SCANSET terminal are set on the keyboard while in Status Mode. For details as to how to access Status Mode and enter values, please refer to the SCANSET user's manual. Set the parameters to the following values:

Parameter	Value	Comments
Baud TX	?	Transmission Baud Rate
Baud RX	?	Reception Baud Rate
Baud Print	?	Printer Baud Rate
Dial - Pulse/Tone	?	Set to Pulse if terminal is connected to a rotary dial phone line. Set to Tone if it is connect=ed to a touch-tone line.
Bit TX/RX	?	Number of data bits transmitted to the connected printer
PAR Print	?	Type of parity - ODD, EVEN or NONE
Brightness	?	Brightness of display - 0 = minimum, 3 = maximum
Beep Col	?	YES causes a beep at the 72nd character entered in a line. NO disables the beep.
Beep Tone	?	Volume of the beep - 0 = minimum, 3 = maximum
Cursor	ESC	Cause an ESC sequence to be transmitted when a cursor key is pressed
Return Key	CR	Transmits a CR upon depression of RETURN
Screen Sizc	80	80-column screen
Duplex	FULL	Full-Duplex Transmission
Scroll	NO	Disables Scrolling
X-ON/X-OFF	?	Set to match logical flow-control selection configured for converter port

NOTE

The auxiliary port on the Scanset terminal can be used with the LinkUp 5294 Auxiliary Printer facility.

F.22 TV910 Terminal Module - Televideo 910

The following list identifies the key sequences defined for the TV910 Terminal Module.

1. Press <CTRL> concurrently with the indicated alpha key.
2. Press <ESC> prior to pressing the indicated alpha key.
3. The last position of the screen (Row 24, Column 80) is designed not to display a character. This prevents automatic scrolling.

5250 Function	Key Sequence	Hex Value Generated
---------------	--------------	---------------------

Cursor Movement:

Character Backspace	CTRL/C	03H
Cursor Up	up arrow	0BH
Cursor Down	down arrow	0AH
Cursor Left	left arrow	08H
Cursor Right	right arrow	0CH
Field Advance	TAB	09H
Field Backspace	BACKTAB	1BH 49H
New Line	CTRL/N	0EH
Fast Left	N. A.	N. A.
Fast Right	N. A.	N. A.

Special Control:

Error Reset	CTRL/R	12H
Insert Mode	CTRL/U	15H
Delete	DEL	7FH
Erase Input	CTRL/E	05H
Home	HOME	1EH

Field Exit:

Duplicate	CTRL/D	04H
Field Minus	CTRL/F	06H
Field Plus	N. A.	N. A.
Field Exit	CTRL/X	18H

Aid Generating:

Enter	ENTER	0DH
Clear	CLEAR	1AH
Help	ESC H	1BH 48H
Print	CTRL/P	10H
Roll Up	ESC U	1BH 55H
Roll Down	ESC D	1BH 44H
CMD 1	ESC 1	1BH 31H
CMD 2	ESC 2	1BH 32H
CMD 3	ESC 3	1BH 33H
CMD 4	ESC 4	1BH 34H
CMD 5	ESC 5	1BH 35H
CMD 6	ESC 6	1BH 36H
CMD 7	ESC 7	1BH 37H
CMD 8	ESC 8	1BH 38H

LINKUP 5294 WITH DL5294 FIRMWARE

5250 Function	Key Sequence	Hex Value Generated
CMD 9	ESC 9	1BH 39H
CMD 10	ESC 0	1BH 30H
CMD 11	ESC -	1BH 2DH
CMD 12	ESC =	1BH 3DH
CMD 13	ESC !	1BH 21H
CMD 14	ESC @	1BH 40H
CMD 15	ESC #	1BH 23H
CMD 16	ESC \$	1BH 24H
CMD 17	ESC %	1BH 25H
CMD 18	ESC ^	1BH 5EH
CMD 19	ESC &	1BH 26H
CMD 20	ESC *	1BH 2AH
CMD 21	ESC (1BH 28H
CMD 22	ESC)	1BH 29H
CMD 23	ESC _	1BH 5FH
CMD 24	ESC +	1BH 2BH

Special Host:

System Request	ESC S	1BH 53H
----------------	-------	---------

Signal

Attn	ESC A	1BH 41H
------	-------	---------

Extended Function:

Local Copy Print Req.	ESC P	1BH 50H
Local Copy Form Feed	ESC F	1BH 46H
Cancel Print	ESC C	1BH 43H
Refresh Screen	CTRL/W	17H
Toggle Status Line/ Toggle Indicators	ESC T	1BH 54H
Toggle Echoplex Enabled	CTRL/V	16H
Initialize Terminal	ESC <	1BH 3CH
Request Disconnect	ESC >	1BH 3EH

TeleVideo: 910 Terminal Setup

1. Disconnect the AC power cord from the outlet before opening the TeleVideo terminal case.
2. There are two sets of 10 switches on the TeleVideo 910, labeled S1 and S2. Set these switches in the following manner.

S1 (Right Rear)	Set To:	Comments
1-4	—	Baud Rate (see list)
5	DOWN	8 data bits
6	? Send parity - UP, No parity - DOWN	(set to match LinkUp)
7	? Even parity - UP; Odd parity - DOWN	(set to match LinkUp)
8	DOWN	1 stop bit (if baud rate is 110, set UP for 2 stop bits)
9	DOWN	Auto wrap off
10	DOWN	Auto Linefeed off

BAUD RATE	SWITCHES			
	1	2	3	4
9600	DOWN	DOWN	DOWN	DOWN
50	DOWN	DOWN	DOWN	UP
75	DOWN	DOWN	UP	DOWN
110	DOWN	DOWN	UP	UP
135	DOWN	UP	DOWN	DOWN
150	DOWN	UP	DOWN	UP
300	DOWN	UP	UP	DOWN
600	DOWN	UP	UP	UP
1200	UP	DOWN	DOWN	DOWN
1800	UP	DOWN	DOWN	UP
2400	UP	DOWN	UP	DOWN
3600	UP	DOWN	UP	UP
4800	UP	UP	DOWN	DOWN
7200	UP	UP	DOWN	UP
9600	UP	UP	UP	DOWN
19200	UP	UP	UP	UP

S1(Left Rear)	Set To:	Comments
1, 2	DOWN	Setting Switches 1 and 2 to the down position sets to standard TV910 emulation
3	? 50 Hz - DOWN (foreign); 60 Hz - UP (U.S.)	
4	? DOWN = Blinking cursor; UP = Steady cursor	
5	? DOWN = Block cursor; UP = Underline cursor	
6	UP Full Duplex	
7	? UP = White on black; DOWN = Black on white	
8	UP No DSR	
9	DOWN DCD connected	
10	DOWN DTR on with terminal	

3. Replace the cover, reconnect the AC power cord, and connect the terminal to the LinkUp 5294 with a modem or direct-connect cable, as appropriate.

NOTE

The auxiliary port on the 910 terminal can be used with the LinkUp 5294 Auxiliary Printer facility. However, be aware that the 910 terminal does not operate its auxiliary printer capability in an industry-standard manner. In other words, the port select/deselect sequences (CTRL/T and ESC/A) the LinkUp 5294 sends to the terminal (to determine if this facility is to be used) are incorrectly passed through to the terminal's auxiliary port (where the printer is connected). If the attached printer interprets them as a command, these sequences will cause printer operation errors.

F.23 TV910P Terminal Module - TeleVideo 910 Plus/912

The following list identifies the key sequences defined for the TV910P Terminal Module.

1. Press <CTRL> concurrently with the indicated alpha key.
2. Press <ESC> prior to pressing the indicated alpha key.
3. The last position of the screen (Row 24, Column 80) is designed to not display a character. This prevents an auto-scroll capability.

LINKUP 5294 WITH DL5294 FIRMWARE

5250 Function	Key Sequence	Hex Value Generated
<i>Cursor Movement:</i>		
Character Backspace	CTRL/	03H
Cursor Up	up arrow	0BH
Cursor Down	down arrow	0AH
Cursor Left	left arrow	08H
Cursor Right	right arrow	0CH
Field Advance	CTRL/I or TAB	09H 09H
Field Backspace	ESC/I or BACKTAB	1BH 49H 1BH 49H
New Line	CTRL/J LINE FEED	0AH 0AH
Fast Left	N.A.	N.A.
Fast Right	N A.	N.A.
<i>Special Control</i>		
Error Reset	CTRL/R	12H
Insert Mode	CTRL/U	15H
Delete	DEL	7_FH
Erase Input	CTRL/E	05H
Home	HOME	1EH
<i>Field Exit:</i>		
Duplicate:	CTRL/D	04H
Field Minus/Plus	CTRL/F	06H
Field Exit	CTRL/X	18H
<i>Aid Generating:</i>		
Enter	ENTER	0DH
Clear	ESC Z	1BH 5AH
Help	ESC H	1BH 48H
Print	CTRL/P	10H
Roll Up	ESC U	1BH 55H
Roll Down	ESC D	1BH 4DH
CMD 1	ESC 1	1BH 31H
CMD 2	ESC 2	1BH 32H
CMD 3	ESC 3	1BH 33H
CMD 4	ESC 4	1BH 34H
CMD 5	ESC 5	1BH 35H
CMD 6	ESC 6	1BH 36H
CMD 7	ESC 7	1BH 37H
CMD 8	ESC 8	1BH 38H
CMD 9	ESC 9	1BH 39H
CMD 10	ESC 0	1BH 30H
CMD 11	ESC -	1BH 2DH
CMD 12	ESC =	1BH 3DH
CMD 13	ESC !	1BH 21H
CMD 14	ESC @	1BH 40H
CMD 15	ESC #	1BH 23H

APPENDIX F: Terminal Modules and ASCII Terminal Setups

5250 Function	Key Sequence	Hex Value Generated
CMD 16	ESC \$	1BH 24H
CMD 17	ESC %	1BH 25H
CMD 18	ESC ^	1BH 5EH
CMD 19	ESC &	1BH 26H
CMD 20	ESC *	1BH 2AH
CMD 21	ESC (1BH 28H
CMD 22	ESC)	1BH 29H
CMD 23	ESC _	1BH 5FH
CMD 24	ESC +	1BH 2BH

Special Host:

System Request	ESC S	1BH 53H
----------------	-------	---------

Signal:

Attn	ESC A	1BH 41H
------	-------	---------

Extended Function:

Local Copy Print Req.	ESC P	1BH 50H
Local Copy Form Feed	ESC F	1BH 46H
Cancel Print	ESC C	1BH 43H
Refresh Screen	CTRL/W	17H
Toggle Status Line/ Toggle Indicators	ESC T	1BH 54H
Toggle Echoplex Enabled	ESC V	1BH 56H
Initialize Terminal	ESC <	1BH 3CH
Request Disconnect	ESC >	1BH 7EH

TeleVideo: 910+ and 912 Terminal Setups

1. Disconnect the AC power cord from the outlet before opening the TeleVideo terminal case.
2. This section describes how to set the terminal switches on the Televideo 910+ and 912 terminals. Although these two terminals use the same terminal module, their switch settings vary. Therefore, the 910+ switch settings will be covered first, followed by the settings of the 912.

910+ S1 (Right Rear)	Set To:	Comments
1-4	—	Baud rate - see chart
5	DOWN	8 data bits
6	? UP	Send parity; DOWN - No parity (set to match the converter)
7	? UP	EVEN parity; DOWN - ODD parity (set to match the converter)
8	DOWN	1 stop bit (if baud rate is 110, set UP for 2 stop bits)
9	DOWN	Auto wrap off
10	DOWN	Auto Linefeed off

LINKUP 5294 WITH DL5294 FIRMWARE

910+ BAUD RATE

SWITCHES

	1	2	3	4
9600	DOWN	DOWN	DOWN	DOWN
50	DOWN	DOWN	DOWN	UP
75	DOWN	DOWN	UP	DOWN
110	DOWN	DOWN	UP	UP
135	DOWN	UP	DOWN	DOWN
150	DOWN	UP	DOWN	UP
300	DOWN	UP	UP	DOWN
600	DOWN	UP	UP	UP
1200	UP	DOWN	DOWN	DOWN
1800	UP	DOWN	DOWN	UP
2400	UP	DOWN	UP	DOWN
3600	UP	DOWN	UP	UP
4800	UP	UP	DOWN	DOWN
7200	UP	UP	DOWN	UP
9600	UP	UP	UP	DOWN
19200	UP	UP	UP	UP

910+ S1 (Left Rear) Set To:

Comments

1	DOWN	Sets Conversational Mode
2	DOWN	Sets Full Duplex
3	?	50 Hz - DOWN (foreign); 60 Hz - UP (U.S.)
4	DOWN	Sets Edit Mode to Duplex
5	?	UP - Underline cursor; DOWN - Block cursor
6	UP	Sets 91 V 920 compatible
7	?	UP - Green on black; DOWN - Black on green
8	UP	No DSR
9	DOWN	DCD connected

910+ S2 (left Resr)

Set To:

Comments

10	DOWN	DTR on with terminal
----	------	----------------------

The S1 switches on the back panel are used to set the baud rate for communications to the LinkUp 5294. The S3 switches are used to set the Printer Port baud rate. Set one of the following S1 and S3 group switches DOWN for the desired terminal baud rate:

912 S1/S3 Switches

Desired Baud Rate

2	9600
3	4800
4	2400
5	1200
6	600
7	300
8	150
9	75
10	110

912 S2 (Left Rear)	Set To:	Comments
1	UP	Not used
2	DOWN	Set Standard Character Set
3	UP	Full Duplex
4	?	50 Hz - UP (foreign); 60 Hz - DOWN (U.S.)
5	?	UP - No Parity; DOWN - Send Parity
6	DOWN	Send 1 Stop Bit—Note that the terminal will automatically send 2 Stop Bits if the baud rate is set to 110 bps.
7	UP	8 Data bits are defined
8	UP	Only necessary for Rev. E and lower
9	?	UP - EVEN parity; DOWN - ODD parity
10	?	UP - Steady cursor; DOWN - Blinking cursor (Rev. E and lower use Jumper W25)

NOTE

To set the S5 switches, you must remove the terminal cover. The S5 group is near the back edge of the circuit board and is labeled S.

912 S5	Set To:	Comments
1	UP	DSR disconnected
2	DOWN	DCD connected
3	OPEN	Used in conjunction with Switch 4
4	DOWN	DTR connected
5	NOT USED	No auxiliary printer support
6-7	DOWN	RS-232

NOTE

Jumper (S4/W33) must be installed on the main circuit board to DISABLE the Auto - New Line at column 80.

3. Replace the cover. Reconnect the AC power cord and connect the terminal to the LinkUp 5294 with a modem or direct-connect cable, as appropriate.

NOTE:

The auxiliary port on the 910 Plus and 912 terminals can be used with the LinkUp 5294 Auxiliary Printer facility.

F.24 TV925 Terminal Module - TeleVideo 920/925/950

The following list identifies the key sequences defined for the TV925 Terminal Module.

1. Press <CTRL> concurrently with the indicated alpha key.
2. Press <ESC> prior to pressing the indicated alpha key.
3. CURSOR DOWN for a 920 terminal is CTRL V.
4. The last position of the screen (Row 24, Column 80) is designed not to display a character. This prevents automatic scrolling.

LINKUP 5294 WITH DL5294 FIRMWARE

5250 Function	Key Sequence	Hex Value Generated
<i>Cursor Movement:</i>		
Character Backspace	CTRL/C	03H
Cursor Up	up arrow	0BH
Cursor Down	down arrow	16H
Cursor Left	left arrow or BACKSPACE	08H
Cursor Right	right arrow	0CH
Field Advance	TAB	09H
Field Backspace	BACKTAB	1BH 49H
New Line	LINE FEED	0AH
Fast Left	N.A.	N.A.
Fast Right	N.A.	N.A.
<i>Special Control:</i>		
Error Reset	CTRL/R	12H
Insert Mode	F3 or CHAR INSERT	01H 42H 0DH 1BH 51H
Delete DEL	7FH or CHAR DELETE	1BH 57H
Erase Input	F4	01H 43H 0DH
Home	HOME	1EH
<i>Field Exit:</i>		
Duplicate	F11	01H 4AH 0DH
Field Minus	F10	01H 49H 0DH
Field Plus	N.A.	N.A.
Field Exit	F9	01H 48H 0DH
<i>Aid Generating:</i>		
Enter	RETURN or ENTER	0DH
Clear	CLEAR SPACE	1AH
Help	F6	01H 45H 0DH
Print	F5	01H 44H 0DH
Roll Up	F7	01H 46H 0DH
Roll Down	F8	01H 47H 0DH
CMD 1	ESC 1	1BH 31H
CMD 2	ESC 2	1BH 32H
CMD 3	ESC 3	1BH 33H
CMD 4	ESC 4	1BH 34H
CMD 5	ESC 5	1BH 35H
CMD 6	ESC 6	1BH 36H
CMD 7	ESC 7	1BH 37H
CMD 8	ESC 8	1BH 38H
CMD 9	ESC 9	1BH 39H
CMD 10	ESC 0	1BH 30H
CMD 11	ESC -	1BH 2DH
CMD 12	ESC =	1BH 3DH
CMD 13	ESC !	1BH 21H
CMD 14	ESC @	1BH 40H
CMD 15	ESC #	1BH 23H

5250 Function	Key Sequence	Hex Value Generated
CMD 16	ESC \$	1BH 24H
CMD 17	ESC %	1BH 25H
CMD 18	ESC ^	1BH 5EH
CMD 19	ESC &	1BH 26H
CMD 20	ESC *	1BH 2AH
CMD 21	ESC (1BH 28H
CMD 22	ESC)	1BH 29H
CMD 23	ESC _	1BH 5FH
CMD 24	ESC +	1BH 2BH

Special Host:

System Request	F1	01H 40H 0DH
----------------	----	-------------

Signal:

Attn	F2	01H 41H 0DH
------	----	-------------

Extended Function:

Local Device Print	ESC P	1BH 50H
Local Printer Form Feed	ESC F	1BH 46H
Cancel Print	ESC C	1BH 43H
Refresh Display	CTRL/W	17H
Toggle Status Line/ Toggle Indicators	ESC T	1BH 54H
Toggle Echoplex Enabled	ESC	1BH 7CH
Initialize Terminal	ESC <	1BH 3CH
Request Disconnect	ESC >	1BH 7EH

TeleVideo: 920, 925, and 950 Terminal Setups

1. Disconnect the AC power cord from the outlet before opening the TeleVideo 925 case.
2. This section describes how to set the terminal switches on the TeleVideo 920, 925, and 950 terminals. Although these three terminals use the same module, their switch settings vary. Therefore, the 920 settings will be covered first, followed by the 925 and 950 settings.

The switches on the 920 terminal are identical to those of the 912 terminal.

Both the 92S and 950 terminals have a Setup Mode available to you for the setting of some of the terminals' options. All of their options can be set by each of the terminal's switches or by the initialization procedure of the LinkUp 5294.

CAUTION

You must be very careful when using Setup Mode. It could be detrimental to the terminal's operation with the LinkUp 5294.

LINKUP 5294 WITH DL5294 FIRMWARE

SI (Right Rear)	Set To:	Comments
1-4	—	Sets the baud rate of the main port (see the baud rates list).
5	DOWN	Sets 8-bit word.
6	DOWN	Sets 1 stop bit. For all baud rates less than or equal to 110 bps 2 stop bits are recommended.
7-10		This sets the baud rate of the printer port. See the following table on setting baud rates.

925+ BAUD RATE	SWITCHES				950+ BAUD RATE
	1/7	2/8	3/9	4/10	
9600	DOWN	DOWN	DOWN	DOWN	9600
50	DOWN	DOWN	DOWN	UP	1200
75	DOWN	DOWN	UP	DOWN	135
110	DOWN	DOWN	UP	UP	4800
135	DOWN	UP	DOWN	DOWN	75
150	DOWN	UP	DOWN	UP	2400
300	DOWN	UP	UP	DOWN	300
600	DOWN	UP	UP	UP	9600
1200	UP	DOWN	DOWN	DOWN	50
1800	UP	DOWN	DOWN	UP	1800
2400	UP	DOWN	UP	DOWN	150
3600	UP	DOWN	UP	UP	7200
4800	UP	UP	DOWN	DOWN	110
7200	UP	UP	DOWN	UP	3600
9600	UP	UP	UP	DOWN	600
19200	UP	UP	UP	UP	19200

SI (Left Rear)	Set To:	Comments
1	925 - DOWN;950-UP	Sct to Duplex edit mode
2	DOWN	925 - Non-912/920 emulation
3, 4, 5	No Parity	950 - Cursor display steady
	Odd Parity	3=DOWN, 4=DOWN, 5=DOWN
	Even Parity	3=DOWN, 4=DOWN, 5 UP
	Mark Parity	3=DOWN, 4=UP, 5=UP
	Space Parity	3=UP, 4=DOWN, 5=UP
6	UP	3=UP, 4=UP, 5=UP
7, 8	925	Set normal block character on a black screen
	UP, DOWN	Full-duplex transmission
	950	
	DOWN, UP	
9	?	DOWN = 50 Hz, UP= 60 Hz
10	925 = DOWN	No auto linefeed
	950 - ?	UP = Key click OFF
		DOWN = Key click ON

On the 925 only, there are 10 toggle-type switches that are only accessible by removing the terminal cover. They are labeled as S3 switches and should be set to the following values:

935 S3 Switches	Set To:	Comments
1	?	UP = Keyclick OFF DOWN = Key click ON
2, 3	DOWN DOWN	Set the language to ENGLISH
4	?	DOWN = blinking cursor UP = steady cursor
5	?	DOWN = block cursor UP = underline cursor
6	DOWN	Time-out blank option disabled
7	UP	Page attributes function enabled, Line attributes function disabled
8	DOWN	CD connected
9	UP	DSR disconnected
10	DOWN	DTR connected

3. Replace the cover, reconnect the AC power cord, and connect the terminal to the converter with a modem or direct-connect cable, as appropriate.

NOTE

The auxiliary port on the 920, 925, and 950 terminals can be used with the LinkUp 5294 Auxiliary Printer facility. However, be aware that the 925 terminal passes the select/deselect sequence (CTRL/T and ESC/A) transmitted by the LinkUp 5294 to determine whether the auxiliary printer facility will be used, through its auxiliary port, to the attached printer. If the printer interprets this sequence as a command, the printer's operation will be adversely affected.

F.25 TV970 Terminal Module - TeleVideo TV-970

The following list identifies the key sequences defined for the TV970 Terminal Module.

1. Press <CTRL> concurrently with indicated alpha key.
2. Press <ESC> prior to pressing the indicated alpha key.

5250 Function	Key Sequence	Hex Value Generated
<i>Cursor Movement:</i>		
Character Backspace	CTRL/H	08H
Cursor Up	up arrow	1BH 5BH 41H
Cursor Down	down arrow	1BH 5BH 42H
Cursor Left	left arrow	1BH 5BH 44H
Cursor Right	right arrow	1BH 5BH 43H
Field Advance	TAB	09H
Field Backspace	BACKTAB	1BH 5BH 5AH
New Line	LINE INSERT or LINEFEED	1BH 5BH 4CH 0AH
Fast Left	N.A.	N.A.
Fast Right	N.A.	N.A.

LINKUP 5294 WITH DL5294 FIRMWARE

5250 Function	Key Sequence	Hex Value Generated
<i>Special Control:</i>		
Error Reset	CTRL/R or F5	12H 1BH 3FH 6FH
Insert Mode	CHARACTER INSERT or F2	1BH 5BH 40H 1BH 3FH 62H
Delete	DEL or SHIFT/F2	7FH 1BH 3FH 42H
Erase Input	PAGE INSERT or SHIFT/F3	1BH 5BH 4AH 1BH 3FH 43H
Home	HOME or F3	1BH 5BH 48H 1BH 3FH 63H
<i>Field Exit:</i>		
Duplicate	CTRL/D or F16	04H 1BH 3FH 70H
Field Minus	CTRL/F	06H
Field Plus	N.A.	N.A.
Field Exit	CTRL/X	18H
<i>Aid Generating:</i>		
Enter	RETURN	0DH
Clear	PAGE ERASE	1BH 5BH 4DH
Help	ESC H or F6	1BH 48H 1BH 3FH 66H
Print	CTRL/P or F4	10H 1BH 3FH 64H
Roll Up	ESC M	1BH 4DH
Roll Down	ESC D	1BH 44H
CMD 1	ESC 1	1BH 31H
CMD 2	ESC 2	1BH 32H
CMD 3	ESC 3	1BH 33H
CMD 4	ESC 4	1BH 34H
CMD 5	ESC 5	1BH 35H
CMD 6	ESC 6	1BH 36H
CMD 7	ESC 7	1BH 37H
CMD 8	ESC 8	1BH 38H
CMD 9	ESC 9	1BH 39H
CMD 10	ESC 0	1BH 30H
CMD 11	ESC -	1BH 2DH
CMD 12	ESC =	1BH 3DH
CMD 13	ESC !	1BH 21H
CMD 14	ESC @	1BH 40H
CMD 15	ESC #	1BH 23H
CMD 16	ESC \$	1BH 24H
CMD 17	ESC %	1BH 25H
CMD 18	ESC ^	1BH 5EH
CMD 19	ESC &	1BH 26H
CMD 20	ESC *	1BH 2AH
CMD 21	ESC (1BH 28H
CMD 22	ESC)	1BH 29H

APPENDIX F: Terminal Modules and ASCII Terminal Setups

5250 Function	Key Sequence	Hex Value Generated
CMD 23	ESC _	1BH 5FH
CMD 24	ESC +	1BH 2BH
<i>Special Host:</i>		
System Request	ESC S or SHIFT/F1	1BH 53H 1BH 3FH 41H
<i>Signal:</i>		
Attn	ESC A or F1	1BH 41H 1BH 3FH 61H
<i>Extended Function:</i>		
Local Copy Print Req.	F9	1BH 3FH 69H
Local Copy Form Feed	F10	1BH 3FH 6AH
Cancel Print	SHIFT/F4	1BH 3FH 44H
Refresh Screen	F7	1BH 3FH 67H
Toggle Status Line/ Toggle Indicators	F8	1BH 3FH 68H
Toggle Echoplex Enabled	F11	1BH 3FH 6BH
Initialize Terminal	ESC <	1BH 3CH
Request Disconnect	ESC >	1BH 3EH

TeleVideo: TV970 Terminal Setup

All operator-selected parameters are input from the keyboard through the TV-970 setup mode; there are no external switches.

1. To enter Setup mode, press **SETUP**. A Setup Menu will appear on the terminal's screen. To exit Setup mode, press **SETUP** a second time. To save the reset parameter values permanently (as opposed to allowing them to revert to previous values following the current session), press **CTRL** and **S** before exiting Setup mode. Set the terminal's parameters as follows:

Identifier	Value	Comments
COMM	CNV	Conversational mode
DUPLX	FDX	Full-Duplex communication
SEND/RCV	NO ECHO	Local terminal echo turned off
BAUD (MAIN)	?	Main port baud rate
PARITY (MAIN)	?	Main port parity
DATA BITS (MAIN)	?	Main port word size
STOP BIT (MAIN)	?	Main port stop bit(s)
RCV CTRL 5294.	?	Set to match flow control on the LinkUp
XMIT CTRL (MAIN) 5294.	?	Set to match flow control on the LinkUp
BAUD (PRINT)	?	Printer port baud rate
PARITY (PRIN'TER)	?	Printer port parity
DATA BITS (PRINTER)	?	Printer port word size
STOP BIT (PRINTER)	?	Printer port stop bit(s)
XMIT CTRL (PRINTER)	?	Set to match flow control on printer being used
PRINT STAT	BUF	Buffered transparent print selected

Identifier	Value	Comments
INS CHAR	N A.	The character which replaces erased data on the screen (three-character decimal value)
INS/RPL	N.A	Insert overwrites/moves current data
CTRL REP	PROC	Terminal processes commands received from the host
AUTOPG	N A.	Screen pages/scrolls when cursor goes beyond 24th line
AUTOWRAP	NO WRAP	Autowrap disabled
EDIT BOUND	N.A	Screen/page editing capability
EDITING EXT	DSPL	Permits insert/delete to affect full screen
HORZ EDIT	N A.	Insert/delete commands affect data to right/left of cursor
VERT EDIT	N.A	Insert/delete commands affect data above/below cursor line
AUTOTAB	N.A.	Cursor moves/does not move into a "guarded area"
GUARDED XFER	ALL	All areas are transmitted and printed as they are displayed
MULTI-AREA XFER	ALL	Allows an unguarded field to be transmitted
XFER TERM	FULL	Defines the data to be transferred as entire page of memory
LN XFER	PG	Transmits through cursor or end-of-page
XFER EXEC	DEFER	SEND key transmit sequence
PG XFER	PG	Allows the entire page to be transmitted
CHAR/LN	132	Allows terminal to display lines of length 132 characters
LN/PG	24	Defines terminal page length as 24 lines
SCRN BACK	?	Displays light on dark or dark on light
SCRN SAVER	?	Screen turns off after n minutes if idle
SCROLL	?	Rate of terminal data display
25TH LINE	?	Use of 25th line; blank, status, or message
1ST CHAR SET	U.S.	U.S. ASCII (only setting)
2ND CHAR SET	U.K.	U.K. ASCII (only setting)
LF/NEW LN	LN FEED	LINE FEED key generates only LF (=0AH), RETURN generates only CR(=0DH)
CURSOR STYLE	?	Manner of cursor display
NORMAL ATTR	HIGH	Normal intensity is defined to be the higher of the two intensities
LN ATTR	NOR	Single-height, single-width character display
POWER/HZ	?	50 Hz or 60 Hz
KEYCLICK	?	Audible or Inaudible
BREAK KEY	IGNORE	BREAK key is ignored when pressed

F.26 VIEWP Terminal Module - ADDS Viewpoint/Regent

The following list identifies the key sequences defined for the VIEWP Terminal Module.

1. Press <CTRL> concurrently with the indicated alpha key.
2. Press <ESC> prior to pressing the indicated alpha key.
3. The last position of the screen (Row 24, Column 80) is designed to not display a character. This prevents automatic scrolling.

APPENDIX F: Terminal Modules and ASCII Terminal Setups

5250 Function	Key Sequence	Hex Value Generated
<i>Cursor Movement:</i>		
Character Backspace	BACKSPACE	08H
Cursor Up	up arrow	AH
Cursor Down	down arrow	0AH
Cursor Left	left arrow	15H
Cursor Right	right arrow	06H
Field Advance	TAB	09H
Field Backspace	CTRL/X or F5	18H 02H 35H
New Line	F3	02H 33H
Fast Left	N.A.	N.A.
Fast Right	N.A.	N.A.
<i>Special Control:</i>		
Error Reset	CTRL/R	12H
Insert Mode	ESC I or F4	1BH 49H 02H 34H
Delete	DEL	7FH
Erase Input	CTRL/E	05H
Home	HOME	1EH
<i>Field Exit:</i>		
Duplicate	CTRL/D or F6	04H 02H 36H
Field Minus	F2	02H 32H
Field Plus	N.A.	N.A.
Field Exit	F1	02H31H
<i>Aid Generating:</i>		
Enter	ENTER	ODH
Clear	ESC BACKSPACE	1BH 08H
Help	ESC H	1BH48H
Print	CTRL/P	10H
Roll Up	ESC U or F7	1BH SSH 02H 37H
Roll Down	ESC D or F8	1BH44H 02H 38H
CMD 1	ESC 1	1BH 31H
CMD 2	ESC 2	1BH 32H
CMD 3	ESC 3	1BH 33H
CMD 4	ESC 4	1BH 34H
CMD 5	ESC 5	1BH 35H
CMD 6	ESC 6	1BH 36H
CMD 7	ESC 7	1BH 37H
CMD 8	ESC 8 •	1BH 38H
CMD 9	ESC 9	1BH 39H
CMD 1	ESC 0	1BH 30H
CMD 11	ESC -	1BH 2DH
CMD 12	ESC =	1BH 3DH

LINKUP 5294 WITH DL5294 FIRMWARE

5250 Function	Key Sequence	Hex Value Generated
CMD 13	ESC !	1BH 21H
CMD 14	ESC @	1BH 40H
CMD 15	ESC #	1BH 23H
CMD 16	ESC \$	1BH 24H
CMD 17	ESC %	1BH 25H
CMD 18	ESC ^	1BH 5EH
CMD 19	ESC &	1BH 26H
CMD 20	ESC *	1BH 2AH
CMD 21	ESC (1BH 28H
CMD 22	ESC)	1BH 29H
CMD 23	ESC _	1BH 5FH
CMD 24	ESC +	1BH 2BH

Special Host:

System Request	ESC S	1BH 53H
----------------	-------	---------

Signal:

Attn	ESC A	1BH 41H
------	-------	---------

Extended Function:

Local Copy Print Req.	ESC P	1BH 50H
Local Printer Form Feed	ESC F	1BH 46H
Cancel Print	ESC C	1BH 43H
Refresh Display	CTRL/W	17H
Toggle Status Line/ Toggle Indicators	ESC T	1BH 54H
Toggle Echoplex Enabled	CTRL/V	16H
Initialize Terminal	ESC <	1BH 3CH
Request Disconnect	ESC >	1BH 7EH

ADDS: Viewpoint and Regent Terminal Setups

Information on the Regent terminal switch settings was not available at the time this document was published. Please refer to the manufacturer's user's manual or contact your supplier.

To set up the Viewpoint terminal for connection to the LinkUp 5294, proceed as follows:

1. Disconnect the AC power cord before removing the cover of the terminal.
2. There are 8 option switches on the right rear of the terminal. Set them as follows:

SI (Right Rear)	Set To:	Comments
1-3	?	See baud rate list
4	0	Auto scroll disabled
5	0	Auto line feed disabled
6	1	Full duplex
7, 8	?	Parity 7 8
		ODD 0 0
		EVEN 0 1
		MARK 1 0
		SPACE 1 1

BAUD RATE	SWITCHES		
	S1-1	S1-2	S1-3
110	0	0	0
150	0	0	1
300	0	1	0
1200	0	1	1
2400	1	0	0
4800	1	0	1
9600	1	1	0
19200	1	1	1

3. There are 8 option switches located inside the Viewpoint on the main printed circuit board. The cover must be removed to set them. The switch group is labeled as S2 and is a few inches up from and to the right of the RS-232 connectors.

S2 (Internal)	Set To:	Comments
1	?	0 = White on black 1 = Black on white
2	0	Disable parity error display
3	?	0 = 60 Hz, 1 = 50 Hz
4, 5, 6	0	U. S. character set
7	?	0 = Steady cursor 1 = Blinking cursor
8	?	0 = Block cursor 1 = Underline cursor

4. Replace the cover, reconnect the AC power cord, and connect the terminal to the LinkUp 5294 with a modem or direct-connect cable, as appropriate.

NOTE

The auxiliary port on the Viewpoint terminal can be used with the LinkUp 5294 Auxiliary Printer facility.

Use of X-ON as the flow control from the LinkUp 5294 may cause garbled screens doing large insert or delete operations on this terminal. For this reason, we recommend that you select NONE as the flow control from the LinkUp 5294 ports using this terminal.

The function keys available on some Regent terminals are not currently supported.

F.27 VP60 Terminal Module - ADDS Viewpoint 60

The following list identifies the key sequences defined for the VP60 Terminal Module.

1. Press <CTRL> concurrently with the indicated alpha key.
2. Press <ESC> prior to pressing the indicated alpha key.

5250 Function	Key Sequence	Hex Value Generated
<i>Cursor Movement</i>		
Character Backspace	BACKSPACE	08H
Cursor Up	up arrow	1AH

LINKUP 5294 WITH DL5294 FIRMWARE

5250 Function	Key Sequence	Hex Value Generated
Cursor Down	down arrow	0AH
Cursor Left	left arrow	15H
Cursor Right	right arrow	06H
Field Advance	CTRL/I or TAB	09H 09H
Field Backspace	CTRL/X	18H
New Line	F3	02H 33H
Fast Left	N.A.	N.A.
Fast Right	N.A.	N.A.
<i>Special Control:</i>		
Error Reset	CTRL/R	12H
Insert Mode	ESC I	1BH 49H
Delete	DEL	7FH
Erase Input	CTRL/E	05H
Home	HOME	1EH
<i>Field Exit:</i>		
Duplicate	CTRL/D	04H
Field Minus	F2	02H 32H
Field Plus	N.A.	N. A.
Field Exit	F1	02H 31H
<i>Aid Generating:</i>		
Enter	ENTER	0DH
Clear	ESC BACKSPACE	1BH 08H
Help	ESC H	1BH 48H
Print	CTRL/P	10H
Roll Up	ESC U	1BH 55H
Roll Down	ESC D	1BH 44H
CMD 1	ESC 1	1BH 31H
CMD 2	ESC 2	1BH 32H
CMD 3	ESC 3	1BH 33H
CMD 4	ESC 4	1BH 34H
CMD 5	ESC 5	1BH 35H
CMD 6	ESC 6	1BH 36H
CMD 7	ESC 7	1BH 37H
CMD 8	ESC 8	1BH 38H
CMD 9	ESC 9	1BH 39H
CMD 10	ESC 0	1BH 30H
CMD 11	ESC -	1BH 2DH
CMD 12	ESC =	1BH 3DH
CMD 13	ESC !	1BH 21H
CMD 14	ESC@	1BH 40H
CMD 15	ESC #	1BH 23H
CMD 16	ESC \$	1BH 24H
CMD 17	ESC %	1BH 2SH
CMD 18	ESC ^	1BH 5EH
CMD 19	ESC &	1BH 26H
CMD 20	ESC *	1BH 2AH

APPENDIX F: Terminal Modules and ASCII Terminal Setups

5250 Function	Key Sequence	Hex Value Generated
CMD 21	ESC (1BH 28H
CMD 22	ESC)	1BH 29H
CMD 23	ESC _	1BH 5FH
CMD 24	ESC +	1BH 2BH

Special Host:

System Request	ESC S	1BH 53H
----------------	-------	---------

Signal:

Attn	ESC A	1BH 41H
------	-------	---------

Extended Function:

Local Copy Print Req.	ESC P	1BH 50H
Local Copy Form Feed	ESC F	1BH 46H
Cancel Print	ESC C	1BH 43H
Refresh Screen	CTRL/W	17H
Toggle Status Line/ Toggle Indicators	ESC T	1BH 54H
Toggle Echoplex Enabled	CTRL/V	16H
Initialize Terminal	ESC <	1BH 3CH
Request Disconnect	ESC >	1BH 7EH

ADDS: VIEWPOINT/60 Terminal Setup

All operator-selected options are input from the keyboard into the Setup Mode Status Line; there are no external switches.

1. Call up the Status Line by pressing <SHIFT> and <HOME> simultaneously. A line containing four option banks of eight bits each will appear on the screen. Set the option values as follows:

Option Bank 1 Value		Comments
1-4	?	Main Port Baud Rate (see list below)
5-8	?	Auxiliary Port Baud Rate (see list below)

BAUD RATE	BIT SETTINGS			
	1/5	2/6	3/7	4/8
110	0	0	0	0
150	0	0	0	1
300	0	0	1	0
1200	0	0	1	1
1800	0	1	0	0
2400	0	1	0	1
4800	0	1	1	0
9600	0	1	1	1
19200	1	0	0	0

Option Bank 2 Value		Comments
1	1	Full Duplex
2	?	0 - Dark Char. on Light Screen 1 - Light Char. on Dark Screen
3	1	Video highlight at full intensity
4	0	Auto Scroll disabled
5	0	Auto Linefeed disabled
6	0	Disable Parity Error Display
7, 8	?	Parity 7 8 ODD 0 0 EVEN 0 1 MARK 1 0 SPACE 1 1

Option Bank 3 Value		Comments
1	?	0 = 60 Hz, 1 = 50 Hz
2	0	Cursor visible
3	?	0 = Block, 1 = Underline Cursor
4	?	0 = Blink, 1 = Steady Cursor
5, 6	0, 0	Upper/Lower case characters
7, 8	0, 0	Line terminator character = CR

Option Bank 4 Value		Comments
1	Reserved	
2	1	Cursor home at upper left enabled
3	?	0 = Keyclick disabled 1 = enabled
4-6	Reserved	

Option Bank 4 Value		Comments
7	0	Regent 40 mode disabled
8	Reserved	

2. Connect the terminal to the LinkUp 5294 with a modem or direct-connect cable, as appropriate.

NOTE

The auxiliary port on the Viewpoint/60 terminal can be used with the LinkUP 5294 Auxiliary Printer facility.

F.28 VT52 Terminal Module - DEC VT52

The following list identifies the key sequences defined for the VT52 Terminal Module.

1. Press <CTRL> concurrently with the indicated alpha key.
2. Press <ESC> prior to pressing the indicated alpha key.
3. NK indicates the indicated key is found in the Numeric Keypad at the lower right of the keyboard. The LinkUp 5294 sets this keypad to Alternate Keypad Mode. (Refer to the VT52X Module if you are using terminals emulating the VT52 terminal but without a numeric keypad.)
4. The last position of the screen (Row 24, Column 80) is designed not to display a character. This prevents automatic scrolling.

APPENDIX F: Terminal Modules and ASCII Terminal Setups

5250 Function	Key Sequence	Hex Value Generated
<i>Cursor Movement:</i>		
Character Backspace	BACKSPACE	08H
Cursor Up	up arrow	1BH 41H
Cursor Down	down arrow	1BH 42H
Cursor Left	left arrow	1BH 44H
Cursor Right	right arrow	1BH 43H
Field Advance	TAB	09H
Field Backspace	PF3	1BH 52H
New Line	LINE FEED	0AH
Fast Left	N A.	N.A.
Fast Right	N.A.	N.A.
<i>Special Control:</i>		
Error Reset	CTRL/R	12H
Insert Mode	NK 7	1BH 3FH 77H
Delete	DELETE	7FH
Erase Input	NK 6	1BH 3FH 76H
Home	NK 8	1BH 3FH 78H
<i>Field Exit:</i>		
Duplicate	NK .	1BH 3FH 6EH
Field Minus	NK 0	1BH 3FH 70H
Field Plus	NK,	1BH 3FH 6CH
Field Exit	RETURN	0DH
<i>Aid Generating:</i>		
Enter	NK ENTER	1BH 3FH 4DH
Clear	NK 3	1BH 3FH 73H
Help	NK 5	1BH 3FH 75H
Print	NK 4	1BH 3FH 74H
Roll Up	NK 1	1BH 3FH 71H
Roll Down	NK 2	1BH 3FH 72H
CMD 1	ESC 1	1BH 31H
CMD 2	ESC 2	1BH 32H
CMD 3	ESC 3	1BH 33H
CMD 4	ESC 4	1BH 34H
CMD 5	ESC 5	1BH 35H
CMD 6	ESC 6	1BH 36H
CMD 7	ESC 7	1BH 37H
CMD 8	ESC 8	1BH 38H
CMD 9	ESC 9	1BH 39H
CMD 10	ESC 0	1BH 30H
CMD 11	ESC -	1BH 2DH
CMD 12	ESC =	1BH 3DH
CMD 13	ESC !	1BH 21H
CMD 14	ESC ~	1BH 40H
CMD 15	ESC #	1BH 23H
CMD 16	ESC \$	1BH 24H
CMD 17	ESC %	1BH 25H

5250 Function	Key Sequence	Hex Value Generated
CMD 18	ESC ^	1BH 5EH
CMD 19	ESC &	1BH 26H
CMD 20	ESC *	1BH 2AH
CMD 21	ESC (1BH 28H
CMD 22	ESC)	1BH 29H
CMD 23	ESC _	1BH 5FH
CMD 24	ESC +	1BH 2BH

Special Host:

System Request	PF1	1BH 50H
----------------	-----	---------

Signal:

Attn	PF2	1BH 51H
------	-----	---------

Extended Function:

Local Copy Print Req.	CTRL/P	10H
Local Printer Form Feed	CTRL/F	06H
Cancel Print	CTRL/K	0BH
Refresh Display	CTRL/W	17H
Toggle Status Line/ Toggle Indicators	CTRL/T	14H
Toggle Echoplex Enabled	CTRL/V	16H
Initialize Terminal	ESC <	1BH 3CH
Request Disconnect	ESC >	1BH 3EH

DEC VT52 Terminal Setup

Information on the VT52 terminal switch settings was not available at the time this document was published. Please refer to the VT52 user's manual or contact your supplier.

F.29 VT52X Terminal Module - DEC VT-52 Emulators

The following list identifies the key sequences defined for the VT52X Terminal Module.

1. Press <CTRL> concurrently with the indicated alpha key.
2. Press <ESC> prior to pressing the indicated alpha key.
3. The last position of the screen (Row 24, Column 80) is designed not to display a character. This prevents an auto-saoll capability.
4. Refer to the VT52 Terminal Module for terminals emulating a VT52, but equipped with a numeric keypad.

5250 Function	Key Sequence	Hex Value Generated
<i>Cursor Movement:</i>		
Character Backspace	BACKSPACE	08H
Cursor Up	up arrow	1BH 41H
Cursor Down	down arrow	1BH 42H
Cursor Left	left arrow	1BH 44H

APPENDIX F: Terminal Modules and ASCII Terminal Setups

5250 Function	Key Sequence	Hex Value Generated
Cursor Right	right arrow	1BH 43H
Field Advance	TAB	09H
Field Backspace	CTRL/B	02H
New Line	CTRL/N	0EH
Fast Left	N.A.	N.A.
Fast Right	N.A.	N.A.
<i>Special Control:</i>		
Error Reset	CTRL/R	12H
Insert Mode	CTRL/J	15H
Delete	DEL	7FH
Erase Input	CTRL/E	05H
Home	ESC H	1BH 48H
<i>Field Exit:</i>		
Duplicate	CTRL/D	04H
Field Minus	CTRL/F	06H
Field Plus	N.A.	N.A.
Field Exit	CTRL/X	18H
<i>Aid Generating:</i>		
Enter	ENTER	0DH
Clear	CTRL/Z	1AH
Help	ESC L	1BH 4CH
Print	CTRL/P	10H
Roll Up	ESC U	1BH 55H
Roll Down	ESC R	1BH 52H
CMD 1	ESC 1	1BH 31H
CMD 2	ESC 2	1BH 32H
CMD 3	ESC 3	1BH 33H
CMD 4	ESC 4	1BH 34H
CMD 5	ESC 5	1BH 35H
CMD 6	ESC 6	1BH 36H
CMD 7	ESC 7	1BH 37H
CMD 8	ESC 8	1BH 38H
CMD 9	ESC 9	1BH 39H
CMD 10	ESC 0	1BH 30H
CMD 11	ESC -	1BH 2DH
CMD 12	ESC =	1BH 3DH
CMD 13	ESC !	1BH 21H
CMD 14	ESC @	1BH 40H
CMD 15	ESC #	1BH 23H
CMD 16	ESC \$	1BH 24H
CMD 17	ESC %	1BH 25H
CMD 18	ESC ^	1BH 5EH
CMD 19	ESC &	1BH 26H
CMD 20	ESC *	1BH 2AH
CMD 21	ESC (1BH 28H
CMD 22	ESC)	1BH 29H

5250 Function	Key Sequence	Hex Value Generated
CMD 23	ESC _	1BH 5FH
CMD 24	ESC +	1BH 2BH
<i>Special Host</i>		
System Request	ESC S	1BH 53H
<i>Signal:</i>		
Attn	ESC E	1BH 45H
<i>Extended Function:</i>		
Local Copy Print Req.	ESC P	1BH 50H
Local Copy Form Feed	ESC F	1BH 46H
Cancel Print	ESC X	1BH 58H
Refresh Screen	CTRL/W	17H
Toggle Status Line/ Toggle Indicators	ESC T	1BH 54H
Toggle Echoplex Enabled	CTRL/V	16H
Initialize Terminal	ESC <	1BH 3CH
Request Disconnect	ESC >	1BH 3EH

VT52 Emulation (w/o Numeric Keypad) Terminal Setup

To support those terminals and software packages providing emulation of a VT52 terminal without a numeric keypad, the VT52X Terminal Module was designed. The setup of any such terminal depends on the particular terminal being used. Please refer to the manufacturer's user's manual or contact your supplier.

F.30 VT100 Terminal Module - DEC VT100

The following list identifies the key sequences defined for the VT100 Terminal Module.

1. Press <CTRL> concurrently with the indicated alpha key.
2. Press <ESC> prior to pressing the indicated alpha key.
3. NK indicates the indicated key is found in the Numeric Keypad at the lower right of the keyboard. The LinkUp 5294 sets this keypad to Alternate Keypad Mode. (Refer to the ANSI Terminal Module for VT100 terminals and compatibles complying with the ANSI Standard 3.64, but without a numeric keypad.)
4. The last position of the screen (Row 24, Column 80) is designed not to display a character. This prevents automatic scrolling.

5250 Function	Key Sequence	Hex Value Generated
<i>Cursor Movement</i>		
Character Backspace	PF1 or BACKSPACE	1BH 4FH 50H 08
Cursor Up	up arrow	1BH 5BH 41H
Cursor Down	down arrow	1BH 5BH 42H
Cursor Left	left arrow	1BH 5BH 44H
Cursor Right	right arrow	1BH 5BH 43H

APPENDIX F: Terminal Modules and ASCII Terminal Setups

5250 Function	Key Sequence	Hex Value Generated
Field Advance	TAB	09H
Field Backspace	PF3	1BH 4FH 52H
New Line	LINE FEED	0AH
Fast Left	N.A.	N A.
Fast Right	N.A.	N.A.
<i>Special Control:</i>		
Error Reset	CTRL/R	12H
Insert Mode	NK 9	1BH 4FH 79H
Delete	DELETE	7FH
Erase Input	NK 4	1BH 4FH 74H
Home	NK 5	1BH 4FH 75H
<i>Field Exit:</i>		
Duplicate	PF4	1BH 4FH 53H
Field Minus	NK -	1BH 4FH 6DH
Field Plus	NK,	1BH 4FH 6CH
Field Exit	RETURN	0DH
<i>Aid Generating:</i>		
Enter	NK ENTER	1BH 4FH 4DH
Clear	NK 2	1BH 4FH 72H
Help	NK 1	1BH 4FH 71H
Print	NK6	1BH 4FH 76H
Roll Up	NK 0	1BH 4FH 70H
Roll Down	NK .	1BH 4FH 6EH
CMD 1	ESC 1	1BH 31H
CMD 2	ESC 2	1BH 32H
CMD 3	ESC 3	1BH 33H
CMD 4	ESC 4	1BH 34H
CMD 5	ESC 5	1BH 35H
CMD 6	ESC 6	1BH 36H
CMD 7	ESC 7	1BH 37H
CMD 8	ESC 8	1BH 38H
CMD 9	ESC 9	1BH 39H
CMD 10	ESC 0	1BH 30H
CMD 11	ESC -	1BH 2DH
CMD 12	ESC =	1BH 3DH
CMD 13	ESC !	1BH 21H
CMD 14	ESC @	1BH 40H
CMD 15	ESC #	1BH 23H
CMD 16	ESC \$	1BH 24H
CMD 17	ESC %	1BH 25H
CMD 18	ESC ^	1BH 5EH
CMD 19	ESC &	1BH 26H
CMD 20	ESC *	1BH 2AH
CMD 21	ESC (1BH 28H
CMD 22	ESC)	1BH 29H
CMD 23	ESC _	1BH 5FH
CMD 24	ESC +	1BH 2BH

LINKUP 5294 WITH DL5294 FIRMWARE

5250 Function	Key Sequence	Hex Value Generated
<i>Special Host:</i>		
System Request	NK 7	1BH 4FH 77H
<i>Signal:</i>		
Attn	NK 8	1BH 4FH 78H
<i>Extended Function:</i>		
Local Copy Print Req.	CTRL/P	10H
Local Copy Form Feed	CTRL/F	06H
Cancel Print	CTRL/C	03H
Refresh Screen	CTRLW	17H
Toggle Status Line/ Toggle Indicators	NK 3	1BH 4FH 73H
Toggle Echoplex Enabled	CTRL/V	16H
Initialize Terminal	ESC <	1BH 3CH
Request Disconnect	ESC >	1BH 3EH

DEC: VT100 Terminal Setup

1. Set power selector switch to 125 V.
2. Turn on the Power Switch and enable the Software option switches through the keyboard (SETUP B procedure). SETUP B mode may only be entered from SETUP A mode by pressing SETUP twice. This mode contains a series of software keys that tailor the terminal to your operating environment. The following values are recommended to interface with the LinkUp 5294.

Byte 1 Switches

(Bit def. from left to right)

	Set To:	Comments
1 (SCROLL)	?	Jump or Smooth Scroll
2 (AUTO REPEAT)	1	Set auto-repeat function enabled
3 (SCREEN)	?	0 = Dark background 1 = Light background

Byte 2 Switches

(Bit def. from left to right)

	Set To:	Comments
4 (CURSOR)	?	0 = Underline cursor 1 = Block Cursor
1 (MARGIN BELL)	—	Enable this option if desired (OFF=0, ON=1)
2 (KEYCLICK)	—	Enable this option if desired (OFF=0, ON=1)
3 (ANSI/VT52)	0	Disable VT52 compatible mode
4 (AUTO X-ON/X-OFF)	0	Should be disabled

Byte 3 Switches (Bit def. from left to right)

	Set To:	Comments
1 (# SWITCH)	0	Set to # character
2 (WRAP AROUND)	0	Disable automatic wrap-around function
3 (NEW LINE)	0	Disable New Line function
4 INTERFACE	0	Should be disabled

Byte 4 Switches (Bit def. from left to right)

	Set To:	Comments
1 (PARITY SENSE)	—	This switch is only appropriate if Bit 2 is set. If so, ODD PARITY = 0 and EVEN PARITY = 1.
2 (PARITY)	—	Set as desired (OFF = 0, ON = 1). If ON = 1 is set, then Bit 1 must also be set to ODD or EVEN parity.
3 (BITS PER CHAR)	?	7 or 8 bits per character.
4 (POWER)	?	0 = 60Hz; 1 = 50Hz

The SETUP B mode screen lets you set the appropriate terminal baud rate. Available baud rates are 50, 75, 110, 134.5, 150, 200, 300, 600, 1200, 1800, 2000, 2400, 3600, 4800, 9600 and 19.2 kbps. Both the transmit baud rate and receive baud rate must be set to the same value. The baud rate specified here must match the baud rate for the LinkUp 5294 port to which this terminal is connected. For all baud rates lower than 150 bps (that is, 50, 75, 110, 134.5), the number of stop bits must be 2.

3. Connect the terminal to the LinkUp 5294 with a modem or direct-connect cable, as appropriate.

F.31 VT220 Terminal Module

The following list shows how the DEC VT220 keyboard is used in emulation of the 5251 keyboard.

1. Press <CTRL> with the indicated alpha key.
2. Press <ESC> prior to pressing the indicated alpha key.

5250 Function	Key Sequence	Hex Value Generated
<i>Cursor Movement</i>		
Character Backspace	BACKSPACE	08H
	or RUBOUT	07H
Cursor Up	up arrow	1BH 5BH 41H
Cursor Down	down arrow	1BH 5BH 42H
Cursor Left	left arrow	1BH 5BH 44H
Cursor Right	right arrow	1BH 5BH 43H
Field Advance	TAB	09H
Field Backspace	F12	1BH 5BH 32HY 34H 7EH
New Line	FIND	1BH 5BH 31H 7EH
Fast Left	CTRL/Z	1AH
Fast Right	CTRL/X	18H

LINKUP 5294 WITH DL5294 FIRMWARE

5250 Function	Key Sequence	Hex Value Generated
<i>Special Control</i>		
Error Reset	F17 or CTRL/R	1BH 5BH 33H 31H 7EH 12H
Insert Mode	F8 or INSERT HERE	1BH 5BH 31H 39H 7EH 1BH 5BH 32H 7EH
Delete	SHIFT/F8 or REMOVE	1BH 5BH 33H 39H 7EH 1BH 5BH 33H 7EH
Erase Input Home	SHIFT/F9 F9	1BH 5BH 34H 30H 7EH 1BH 5BH 32H 30H 7EH
<i>Field Exit:</i>		
Duplicate Field Minus	F20 PF4 or F19	1BH 5BH 33H 34H 7EH 1BH 4FH 53H 1BH 5BH 33H 33H 7EH
Field Plus Field Exit	PF3 RETURN or NK ENTER	1BH 4FH 52H 0DH 0DH
<i>Aid Generating:</i>		
Enter	SELECT or LINE FEED or F14 or DO	1BH 5BH 34H 7EH 0AH 1BH 5BH 32H 36H 7EH 1BH 5BH 32H 39H 7EH
Clear	F13	1BH 5BH 32H 35H 7EH
Help	HELP	1BH 5BH 32H 38H 7EH
Print	F10	1BH 5BH 32H 31H 7EH
Roll Up	NEXT SCREEN	1BH 5BH 36H 7EH
Roll Down	PREV SCREEN	1BH 5BH 35H 7EH
CMD	F7	1BH 5BH 31H 38H 7EH
CMD 1	F7 1	1BH 5BH 31H 38H 7EH 31H
CMD 2	F7 2	1BH 5BH 31H 38H 7EH 32H
CMD 3	F7 3	1BH 5BH 31H 38H 7EH 33H
CMD 4	F7 4	1BH 5BH 31H 38H 7EH 34H
CMD 5	F7 5	1BH 5BH 31H 38H 7EH 35H
CMD 6	F7 6	1BH 5BH 31H 38H 7EH 36H
CMD 7	F7 7	1BH 5BH 31H 38H 7EH 37H
CMD 8	F7 8	1BH 5BH 31H 38H 7EH 38H
CMD 9	F7 9	1BH 5BH 31H 38H 7EH 39H
CMD 10	F7 0	1BH 5BH 31H 38H 7EH 30H
CMD 11	F7-	1BH 5BH 31H 38H 7EH 2DH
CMD 12	F7 =	1BH 5BH 31H 38H 7EH 3DH
CMD 13	F7 !	1BH 5BH 31H 38H 7EH 21H
CMD 14	F7 @	1BH 5BH 31H 38H 7EH 40H
CMD 15	F7 #	1BH 5BH 31H 38H 7EH 23H
CMD 16	F7 \$	1BH 5BH 31H 38H 7EH 24H
CMD 17	F7 %	1BH 5BH 31H 38H 7EH 25H
CMD 18	F7 ^	1BH 5BH 31H 38H 7EH 5EH
CMD 19	F7 &	1BH 5BH 31H 38H 7EH 26H
CMD 20	F7 *	1BH 5BH 31H 38H 7EH 2AH

APPENDIX F: Terminal Modules and ASCII Terminal Setups

5250 Function	Key Sequence	Hex Value Generated
CMD 21	F7 (1BH 5BH 31H 38H 7EH 28H
CMD 22	F7)	1BH 5BH 3 1H 38H 7EH 29H
CMD 23	F7 (underline)	1BH 5BH 31H 38H 7EH 5FH
CMD 24	F7 +	1BH 5BH 31H 38H 7EH 2BH

Special Host:

System Request	NK 7	1BH 4FH 77H
----------------	------	-------------

Signal:

Attn	NK 8	1BH 4FH 78H
------	------	-------------

Extended Function:

Cancel Print	SHIFT/F10 or ESC Z	1BH 5BH 34H 31H 7EH 1BH 5AH
Refresh Screen	F11Z CTRL/W or F18	1BH 5BH 32H 33H 7EH 5AH 17H 1BH 5BH 33H 32H 7EH
Initialize Terminal	ESC < or F11 <	1BH 3CH 1BH 5BH 32H 33H 7EH 3CH
Toggle Indicators	ESC T or F11 T	1BH 54H 1BH 5BH 32H 33H 7EH 54
Request Disconnect	ESC > or F11>	1BH 3EH 1BH 5BH 32H 33H 7EH 3EH

VT220 Terminal Setup

The VT220 terminal uses a series of Setup screens for the selection of operating characteristics. Use of these screens is discussed in detail in the VT220 terminal owner's manual. Each Setup screen contains a number of fields which in turn are used to establish parameter settings. The following parameter settings are suggested for use with the LinkUp 5294

Setup Screen	Field	Setting/Comments
DISPLAY	Columns	80 colums
	Interpret/Display Controls	Interpret
	Auto Wrap	No Auto Wrap
	Scrolling	No effect
	Text Screen	As desired (Selects text and background intensity)
	Text Cursor	As desired (display or non-display of cursor)
GENERAL	Cursor Style	As desired (block cursor is better with underscore fields)
	Mode	VT200 7-bit controls
	User-defined keys	Unlocked
	User Features	Unlocked
	Keypad	Will be overridden
	Cursor Keys	Will be overridden
New Line/No New Line	No New Line	

Setup Screen	Field	Setting/Comments
COMM	Transmit = (baud rate)	Set to match converter
	Receive = (baud rate)	Transmit
	XOFF	128
	Bits, Parity (main port)	Set to match converter
	Stop Bits	Set to match converter
	Local Echo	No Local Echo
	Port Type	EIA Port, Data Leads only
PRINTER	Disconnect Delay	Two-second Delay
	Speed = (baud)	As required by printer
	Mode	Normal Print
	Bits, Parity (aux port)	As required by printer
	Stop Bits	As required by printer
	Print Full Page/Scroll Reg.	Scroll region
KEYBOARD	Printed Data Type	Determined by type of printer attached
	Print Terminator	No Terminator
	Key Types	As determined by your application and country
	Caps/Shift Lock	As desired
	Auto Repeat	As desired
	Keyclick	As desired
	Margin Bell	As desired
	Warning Bell	As desired
	Break/No break	No Break
Auto Answerback	Off	

NOTE

The PR port on the VT220 is used for the Auxiliary Printer feature. For a description of this feature, see the appropriate user's guide. This port requires a male DB9 connector on the interface cable.

F.32 WY30 Terminal Module - Wyse WY30

The following list identifies the key sequences defined for the WY30 Terminal Module.

1. Press the <CTRL> key concurrently with the indicated alpha key.
2. Press the <ESC> key prior to pressing the indicated alpha key.

5250 Function	Key Sequence	Hex Value Generated
<i>Cursor Movement</i>		
Character Backspace	left arrow	03H
Cursor Up	up arrow	0BH
Cursor Down	down arrow	0AH
Cursor Left	left arrow	08H
Cursor Right	right arrow	0CH
Field Advance	right arrow	09H
Field Backspace	left arrow	01H 40H 0DH
New Line	NEW LINE symbol	0EH
Fast Left	N.A.	N.A.
Fast Right	N.A.	N.A.

APPENDIX F: Terminal Modules and ASCII Terminal Setups

5250 Function	Key Sequence	Hex Value Generated
<i>Special Control</i>		
Error Reset	ERROR RESET	7FH
Insert Mode	INS	01H 42H 0DH
Delete	DEL	1BH 71H
Erase Input	ERASE INPUT	01H 44H 0DH
Home	HOME	1EH
<i>Field Exit</i>		
Duplicate	DUP	01H 43H 0DH
Field Minus	FIELD -	1BH 72H
Field Plus	N.A.	N A.
Field Exit	FIELD EXIT	0DH
<i>Aid Generating</i>		
Enter	NK ENTER	1BH 0DH
Clear	CLEAR	01H 41H 0DH
Help	HELP	01H 61H 0DH
Print	PRINT	01H 60H 0DH
Roll Up	ROLL^	01H 62H 0DH
Roll Down	ROLL	01H 63H 0DH
CMD 1	CMD 1	1BH 31H
CMD 2	CMD 2	1BH 32H
CMD 3	CMD 3	1BH 33H
CMD 4	CMD 4	1BH 34H
CMD 5	CMD 5	1BH 35H
CMD 6	CMD 6	1BH 36H
CMD 7	CMD 7	1BH 37H
CMD 8	CMD 8	1BH 38H
CMD 9	CMD 9	1BH 39H
CMD 10	CMD 0	1BH 30H
CMD 11	CMD-	1BH 2DH
CMD 12	CMD =	1BH 3DH
CMD 13	CMD !	1BH 21H
CMD 14	CMD @	1BH 40H
CMD 15	CMD #	1BH 23H
CMD 16	CMD \$	1BH 24H
CMD 17	CMD %	1BH 25H
CMD 18	CMD ^	1BH 5EH
CMD 19	CMD &	1BH 26H
CMD 20	CMD *	1BH 2AH
CMD 21	CMD (1BH 28H
CMD 22	CMD)	1BH 29H
CMD 23	CMD _	1BH 5FH
CMD 24	CMD +	1BH 2BH
<i>Special Host</i>		
System Request	SYS REQ	01H 45H 0DH

5250 Function	Key Sequence	Hex Value Generated
<i>Signal</i>		
Attn	ATTN	01H 46H 0DH
<i>Special Function</i>		
Cancel Print	ESC C	1BH 43H
Refresh Display	CTRL/W	17H
Initialize Terminal	ESC <	1BH 3CH
Toggle Indicators	ESC T	1BH 54H
Request Disconnect	ESC >	1BH 3EH
Local Copy Print Req.	ESC P	1BH 50H
Local Copy Form Feed	ESC F	1BH 46H
Toggle Echo	CTRL/V	16H

F.33 WY60 Terminal Module - Wyse WY60

The following list identifies the key sequences defined for the WY60 Terminal Module.

1. Press the <CTRL> key concurrently with the indicated alpha key.
2. Press the <ESC> key prior to pressing the indicated alpha key.

5250 Function	Key Sequence	Hex Value Generated
<i>Cursor Movement</i>		
Character Backspace	left arrow	08H
CursorUp	F7	01H 46H 0DH
Cursor Down	F8	01H 47H 0DH
Cursor Left	F9	01H 48H 0DH
Cursor Right	F10	01H49H 0DH
Field Advance	TAB	09H
Field Backspace	BACKTAB	1BH 49H
New Line	SHIFT/ENTER	1BH 4EH
Fast Left	SHIFT/F9	01H 68H 0DH
Fast Right	SHIFT/F10	01H 69H 0DH
<i>Special Control</i>		
Error Reset	*/PRTSCR	1BH 50H
Insert Mode	F3	01H 42H 0DH
Delete	SHIFT/F3	01H 62H 0DH
Erase Input	SHIFT/F4	01H 63H 0DH
Home	F4	01H 43H 0DH
<i>Field Exit</i>		
Duplicate	SHIFT/NK -	1BH 44H
Field Minus	NEC -	01H 2DH
Field Plus	NK +	01H 2BH
Field Exit	ENTER	0DH

APPENDIX F: Terminal Modules and ASCII Terminal Setups

5250 Function	Key Sequence	Hex Value Generated
<i>Aid</i>		
Enter	ESC ENTER	1BH 0DH
Clear	CTRL/C	03H
Help	F6	01H 45H 0DH
Print	F5	01H 44H 0DH
Roll Up	SHIFT/F7	01H 66H 0DH
Roll Down	SHIFT/F8	01H 67H 0DH
CMD 1	ESC 1	1BH 31H
CMD 2	ESC 2	1BH 32H
CMD 3	ESC 3	1BH 33H
CMD 4	ESC 4	1BH 34H
CMD 5	ESC 5	1BH 35H
CMD 6	ESC 6	1BH 36H
CMD 7	ESC 7	1BH 37H
CMD 8	ESC 8	1BH 38H
CMD 9	ESC 9	1BH 39H
CMD 10	ESC 0	1BH 30H
CMD 11	ESC -	1BH 2DH
CMD 12	ESC =	1BH 3DH
CMD 13	ESC !	1BH 21H
CMD 14	ESC @	1BH 40H
CMD 15	ESC #	1BH 23H
CMD 16	ESC \$	1BH 24H
CMD 17	ESC %	1BH 25H
CMD 18	ESC ^	1BH 5EH
CMD 19	ESC &	1BH 26H
CMD 20	ESC *	1BH 2AH
CMD 21	ESC (1BH 28H
CMD 22	ESC)	1BH 29H
CMD 23	ESC _	1BH 5FH
CMD 24	ESC +	1BH 2BH
<i>Special Host</i>		
System Request	SHIFT/F1	01H 60H 0DH
<i>Signal</i>		
Attn	F1	01H 40H 0DH
<i>Special Function</i>		
Cancel Print	ESC Z	1BH 5AH
Refresh Display	CTRL/W	17H
Init Terminal	ESC <	1BH 3CH
Toggle Indicators	ESC T	1BH 54H
Request Disconnect	ESC >	1BH 3EH
Local Copy Print Req.	CTRL/P	10H
Local Copy Form Feed	CTRL/F	06H
Toggle Echo	CTRL/V	16H

F.34 WY60X Terminal Module - Wyse WY60 with Extended Keyboard

The following list identifies the key sequences defined for the WY60X Terminal Module.

1. Press the < CTRL > key concurrently with the indicated alpha key.
2. Press the < ESC > key prior to pressing the indicated alpha key.

5250 Function	Key Sequence	Hex Value Generated
<i>Cursor Movement</i>		
Character Backspace	left arrow	08H
Cursor Up	up arrow	0BH
Cursor Down	down arrow	0AH
Cursor Left	left arrow	04H
Cursor Right	right arrow	0CH
Field Advance	TAB	09H
Field Backspace	SHIFT/TAB	1BH 49H
New Line	SHIFT/ENTER	1BH 4EH
Fast Left	SHIFT/left arrow	1BH 04H
Fast Right	SHIFT/right arrow	1BH 0CH
<i>Special Control</i>		
Error Reset	END or CTRL/R	1BH 54H 12H
Insert Mode	INSERT	1BH 72H
Delete	DELETE CHAR or NK DELETE	1BH 57H 7FH
Erase Input	SHIFT/DELETE	1BH 52H
Home	HOME	1EH
<i>Field Exit</i>		
Duplicate	SHIFT/INSERT	1BH 71H
Field Minus	CTRL/F	06H
Field Plus	CTRL/P	10H
Field Exit	RETURN	0DH
<i>Aid</i>		
Enter	NK ENTER	1BH 0DH
Clear	SHIFT/HOME	1BH 7BH
Help	SHIFT/END	1BH 59H
Print	PRINT SCREEN	1BH 50H
Roll Up	PAGE DOWN	1BH 4BH
Roll Down	PAGE UP	1BH 4AH
CMD 1	F1	01H 40H 0DH
CMD 2	F2	01H 41H 0DH
CMD 3	F3	01H 42H 0DH
CMD 4	F4	01H 43H 0DH
CMD 5	F5	01H 44H 0DH
CMD 6	F6	01H 45H 0DH
CMD 7	F7	01H 46H 0DH
CMD 8	F8	01H 47H 0DH

5250 Function	Key Sequence	Hex Value Generated
CMD 9	F9	01H 48H 0DH
CMD 10	F10	01H 49H 0DH
CMD 11	F11	01H 4AH 0DH
CMD 12	F12	01H 4BH 0DH
CMD 13	SHIFT/F1	01H 60H 0DH
CMD 14	SHIFT/F2	01H 61H 0DH
CMD 15	SHIFT/F3	01H 62H 0DH
CMD 16	SHIFT/F4	01H 63H 0DH
CMD 17	SHIFT/F5	01H 64H 0DH
CMD 18	SHIFT/F6	01H 65H 0DH
CMD 19	SHIFT/F7	01H 66H 0DH
CMD 20	SHIFT/F8	01H 67H 0DH
CMD 21	SHIFT/F9	01H 68H 0DH
CMD 22	SHIFT/F10	01H 69H 0DH
CMD 23	SHIFT/F11	01H 6AH 0DH
CMD 24	SHIFT/F12	01H 6BH 0DH

Special Host

System Request	SHIFT/PRINT SCREEN	1BH 53H
----------------	--------------------	---------

Signal

Attn	SHIFT/ESC	1BH 41H
------	-----------	---------

Special Function

Cancel Print	ESC Z	1BH 5AH
Refresh Display	CTRL/W	17H
Initialize Terminal	ESC <	1BH 3CH
Toggle Indicators	CTRL/T	14H
Request Disconnect	ESC >	1BH 3EH
Local Copy Print Req.	CTRL/P	10H
Local Copy Form Feed	CTRL/F	06H
Toggle Echo	CTRL/V	16H

F.35 WY100 Terminal Module - Wyse WY100

The following list identifies the key sequence defined for the WY100 Terminal Module.

1. Press <CTRL> concurrently with the indicated alpha key.
2. Press <ESC> prior to pressing the indicated alpha key.

5250 Function	Key Sequence	Hex Value Generated
<i>Cursor Movement</i>		
Character Backspace	CTRL/C	03H
Cursor Up	up arrow	0BH
Cursor Down	down arrow	0AH
Cursor Left	left arrow	08H
Cursor Right	right arrow	0CH
Field Advance	TAB	09H

LINKUP 5294 WITH DL5294 FIRMWARE

5250 Function	Key Sequence	Hex Value Generated
Field Backspace	SHIFTED TAB	1BH 49H
New Line	NEW LINE	1FH
Fast Left	N.A.	N.A.
Fast Right	N.A.	N.A.
<i>Special Control</i>		
Error Reset	CTRL/R	12H
Insert Mode	LINE INSERT	1BH 45H
Delete	RUBOUT	7FH
Erase Input	CTRL/E	05H
Home	HOME	1EH
<i>Field Exit</i>		
Duplicate	CTRL/D	04H
Field Minus	CTRL/F	06H
Filed Plus	N.A.	N.A.
Field Exit	CTRL/X	18H
<i>Aid Generating</i>		
Enter	RETURN	0DH
Clear	PAGE ERASE	1BH 59H
Help	ESC H	1BH 48H
Print	CTRL/P	10H
Roll Up	ESC U	1BH 55H
Roll Down	ESC D	1BH 44H
CMD 1	ESC 1	1BH 31H
CMD 2	ESC 2	1BH 32H
CMD 3	ESC 3	1BH 33H
CMD 4	ESC 4	1BH 34H
CMD 5	ESC 5	1BH 35H
CMD 6	ESC 6	1BH 36H
CMD 7	ESC 7	1BH 37H
CMD 8	ESC 8	1BH 38H
CMD 9	ESC 9	1BH 39H
CMD 10	ESC 0	1BH 30H
CMD 11	ESC -	1BH 2DH
CMD 12	ESC =	1BH 3DH
CMD 13	ESC!	1BH 21H
CMD 14	ESC @	1BH 40H
CMD 15	ESC #	1BH 23H
CMD 16	ESC \$	1BH 24H
CMD 17	ESC %	1BH 25H
CMD 18	ESC ^	1BH 5EH
CMD 19	ESC &	1BH 26H
CMD 20	ESC *	1BH 2AH
CMD 21	ESC (1BH 28H
CMD 22	ESC)	1BH 29H
CMD 23	ESC _	1BH 5FH
CMD 24	ESC+	1BH 2BH

5250 Function	Key Sequence	Hex Value Generated
<i>Special Host</i>		
System Request	ESC S	1BH 53H
<i>Signal</i>		
Attn	ESC A	1BH 41H
<i>Extended Function</i>		
Local Copy Print Req.	PRINT	1BH 40 H
Local Copy Form Feed	ESC F	1BH 46H
Cancel Print	ESC C	1BH 43H
Refresh Screen	CTRL/W	17H
Toggle Status Line/ Toggle Indicators	ESC T	1BH 54H
Toggle Echoplex Enabled	CTRL/V	16H
Initialize Terminal	ESC <	1BH 3CH
Request Disconnect	ESC >	1BH 3EH

WYSE: WY-100 Terminal Setup

1. Disconnect the AC power cord from the outlet before setting the option switches.
2. There are three banks of toggle-type switches, each with 8 switches, located on the keyboard. These switches should be set to the following values.

SW1	Set To:	Comments
1	ON	Edit keys are set up as duplex keys (host-controllable)
2	OFF	
3	ON	End of line = US
4	ON	End of transmission + CR
5-8	?	Disable auto-new-line
		ENTER and RETURN both generate CR character
		Sets the printer port baud rate
SW2	Set To:	Comments
1	ON	8-bit data
2	?	ON = even parity
		OFF = odd parity
3	OFF	1 stop bit. If a baud rate 100 or less is selected, set to ON = 2 stop bits.
4	OFF	Parity disabled
5-8	?	Sets the modem-port baud rate

LINKUP 5294 WITH DL5294 FIRMWARE

BAUD RATE	SWITCHES			
	5	6	7	8
9600	OFF	OFF	OFF	ON
7200	OFF	OFF	ON	OFF
4800	OFF	OFF	ON	ON
3600	OFF	ON	OFF	OFF
2400	OFF	ON	OFF	ON
2000	OFF	ON	ON	OFF
1800	OFF	ON	ON	ON
1200	ON	OFF	OFF	OFF
600	ON	OFF	OFF	ON
300	ON	OFF	ON	OFF
150	ON	OFF	ON	ON
134.5	ON	ON	OFF	OFF
110	ON	ON	OFF	ON
75	ON	ON	ON	OFF
50	ON	ON	ON	ON

SW3	Set To:	Comments
1	OFF	1 page (1920 character) memory
2	?	OFF = 60 Hz power source ON = 50 Hz power source
3 and 4	OFF	Normal display mode
5	?	OFF = black screen ON = white screen
6	?	OFF = blinking cursor ON = Non-blinking cursor
7	OFF	Full duplex
8	OFF	Conversation

3. Reconnect the AC power cord and connect the terminal to the LinkUp 5294 with a modem or direct connect cable, as appropriate.

F.36 XT100 Terminal Module

The following list identifies the key sequences defined for the XT100 Terminal Module.

5250 Function	Key Sequence	Hex Value Generated
<i>Cursor Movement:</i>		
Character Backspace	PF1 or BACKSPACE	1BH 4FH 50H 08H
Cursor Up	up arrow	1BH 5BH 41H
Cursor Down	down arrow	1BH 5BH 42H
Cursor Left	left arrow	1BH 5BH 44H
Cursor Right	right arrow	1BH 5BH 43H
Field Advance	TAB	09H
Field Backspace	CTRL/A A	01H 41H
New Line	LINE FEED	0AH
Fast Left	N.A.	N.A.
Fast Right	N.A.	N.A.

APPENDIX F: Terminal Modules and ASCII Terminal Setups

5250 Function	Key Sequence	Hex Value Generated
<i>Special Control</i>		
Error Reset	CTRL/R	12H
Insert Mode	CTRL/A B	01H 42H
Delete	DELETE	7FH
Erase Input	CTRL/A C	01H 43H
Home	CTRL/A D	01H 44H
<i>Field Exit:</i>		
Duplicate	CTRL/A E	01H 45H
Field Minus	CTRL/A F	01H 46H
Field Plus	CTRL/A G	01H 47H
Field Exit	RETURN	0DH
<i>Aid Generating</i>		
Enter	CTRL/A H	01H 48H
Clear	CTRL/A I	01H 49H
Help	CTRL/A J	01H 4AH
Print	CTRL/A K	01H 4BH
Roll Up	CTRL/A L	01H 4CH
Roll Down	CTRL/A M	01H 4DH
CMD 1	CTRL/A 1	01H 31H
CMD 2	CTRL/A 2	01H 32H
CMD 3	CTRL/A 3	01H 33H
CMD 4	CTRL/A 4	01H 34H
CMD 5	CTRL/A 5	01H 35H
CMD 6	CTRL/A 6	01H 36H
CMD 7	CTRL/A 7	01H 37H
CMD 8	CTRL/A 8	01H 38H
CMD 9	CTRL/A 9	01H 39H
CMD 10	CTRL/A 10	01H 30H
CMD 11	CTRL/A -	01H 2DH
CMD 12	CTRL/A =	01H 3DH
CMD 13	CTRL/A !	01H 21H
CMD 14	CTRL/A @	01H 40H
CMD 15	CTRL/A #	01H 23H
CMD 16	CTRL/A \$	01H 24H
CMD 17	CTRL/A %	01H 25H
CMD 18	CTRL/A ^	01H 5EH
CMD 19	CTRL/A &	01H 26H
CMD 20	CTRL/A *	01H 2AH
CMD 21	CTRL/A (01H 28H
CMD 22	CTRL/A)	01H 29H
CMD 23	CTRL/A _	01H 5FH
CMD 24	CTRL/A +	01H 2BH
<i>Special Host</i>		
System Request	CTRL/A N	01H 4EH

LINKUP 5294 WITH DL5294 FIRMWARE

5250 Function	Key Sequence	Hex Value Generated
<i>Signal</i>		
Attn	CTRL/A O	01H 4FH
<i>Extended Function</i>		
Local Copy Print Req.	CTRL/P	10H
Local Copy Form Feed	CTRL/F	06H
Cancel Print	CTRL/C	03H
Refresh Screen	CTRL/W	17H
Toggle Status Line/ Toggle Indicators	NK 3	1BH 4FH 73H
Toggle Echoplex Enabled	CTRL/V	16H
Initialize Terminal	ESC <	1BH 3CH
Request Disconnect	ESC >	1BH 3EH



© Copyright 1992. Black Box Corporation. All rights reserved.

1000 Park Drive • Lawrence, PA 15055-1018 • 724-746-5500 • Fax 724-746-0746